

OSMANLI ALÜMİNYUM;

2003 YILINDA GİRDİĞİ ALÜMİNYUM SEKTÖRÜNDE
ÇAĞI VE TEKNOLOJİYİ YAKALAYARAK KISA BİR
ZAMANDA LİDER FİRMALAR ARASINDA
YERALMIŞTIR. KONUMUNDA TEK OLAN YURTIÇI
VE YURTDIŞINI AŞAN 5000'İ AŞKIN MÜŞTERİ
PORTFÖYÜ İLE HER GEÇEN GÜN KENDİNİ
YENİLEYEN VE GELİŞTİREN TEDARİKÇİNİZ
OLARAK SİZLERE HİZMET ETMEKTEN
MUTLULUK DUYARIZ.

SAYGIDEĞER MÜŞTERİLERİMİZ ;
SÜREKLİLİK GETİREN BİR ÇÖZÜM, KÖKLÜ
BİR İLİŞKİ, KALİTELİ HİZMET İSTİYORSANIZ,
SİZLERİ OSMANLI ALÜMİNYUM LTD. ŞTİ.'İNDE
ZENGİN ÇEŞİTLERİMİZ VE HER GEÇEN GÜNDE
ÜRÜN YELPAZESİNİ GENİŞLETEN FIRMAMIZ
SİZLERİN BULUNDUĞU HER NOKTADA
SINIRSIZ HİZMET ANLAYIŞIMIZLA
HİZMET VERİYORUZ...

SAYGILARIMIZLA

Osman Türkyılmaz

Bünyamin Eker

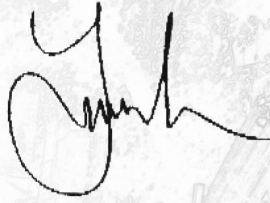

- ❖ ÖZEL EBATLARDA BORU, KUTU, LAMA, KÖŞEBENT ÇEŞİTLERİ
- ❖ AYDINLATMA ve REKLAM PROFİLLERİ
- ❖ SOĞUTUCU ve LED PROFİLLERİ
- ❖ MOBİLYA ve SANAYİ PROFİLLERİ
- ❖ ÖZEL KALIP ÇİZİMLERİ ve İMALATI
- ❖ ELOKSALLI ve PRES PLAKA LEVHALARI
- ❖ GOFRAJLI ve DÜZ PARLAK RULO LEVHALARI
- ❖ LEVHA KESİM - BÜKÜM (ÖZEL ÖLÇÜLERİNİZDE)
- ❖ DELİKLİ ve DEKORATİF TELLER
- ❖ PLEXI - FOLYO - DEKOTE - POLYCARBON - KOMPOZİT VB.

*İyi bir kaptan küçük denizlerde yol alırken hedefi okyanusları aşmak olmalı,
rotasını ona göre ayarlamalı.*

- ❖ ÖZEL EBATLARDA BORU, KUTU, LAMA, KÖŞEBENT ÇEŞİTLERİ
- ❖ AYDINLATMA ve REKLAM PROFİLLERİ
- ❖ SOĞUTUCU ve LED PROFİLLERİ
- ❖ MOBİLYA ve SANAYİ PROFİLLERİ
- ❖ ÖZEL KALIP ÇİZİMLERİ ve İMALATI
- ❖ ELOKSALLI ve PRES PLAKA LEVHALARI
- ❖ GOFRAJLI ve DÜZ PARLAK RULO LEVHALARI
- ❖ LEVHA KESİM - BÜKÜM (ÖZEL ÖLÇÜLERİNİZDE)
- ❖ DELİKLİ ve DEKORATİF TELLER
- ❖ PLEXI - FOLYO - DEKOTE - POLYCARBON - KOMPOZİT VB.

Tarafımızdan imal edilen hazır döner çubuğu profili istediğiniz ölçü ve ebatla temin edilmektedir.

Döner askı çubuklarımız gıda sektörünün ön gördüğü koşullarda hazırlanıp tarafınıza kargo, ambar şeklinde sevk edilmektedir. Ayrıca İstanbul içi tarafımızdan 250 kg. geçmek şartıyla adrese teslim sevkiyatımız vardır hazır balyalar halinde mağazamızda stoklarımızda bulunmaktadır istediğiniz takdirde kendiniz mağazamızdan'da malzemenizi temin edebilirsiniz .

Satışlarımız adet değil kilogram olmaktadır.

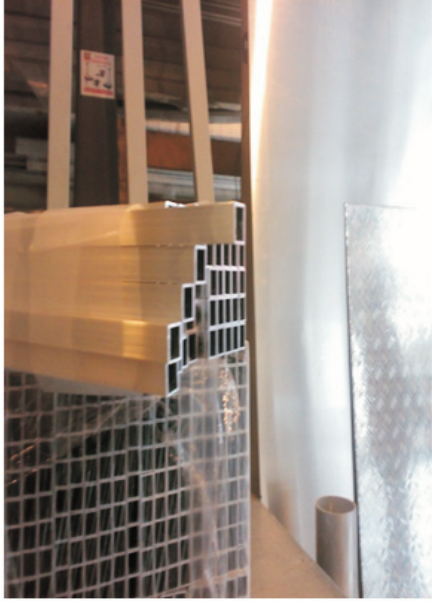

1 Platform Konumu
Platform Position



2 A Tipi Konumu
A Type Location



3 Açık Konum
Open Location



4 Kapalı Konumu
Off Position





OSMANLI
ALÜMİNYUM SAN. ve TİC. LTD. ŞTİ.

- ❖ ÖZEL EBATLARDA BORU, KUTU, LAMA, KÖŞEBENT ÇEŞİTLERİ
- ❖ AYDINLATMA ve REKLAM PROFİLLERİ
- ❖ SOĞUTUCU ve LED PROFİLLERİ
- ❖ MOBİLYA ve SANAYİ PROFİLLERİ
- ❖ ÖZEL KALIP ÇİZİMLERİ ve İMALATI
- ❖ ELOKSALLI ve PRES PLAKA LEVHALARI
- ❖ GOFRAJLI ve DÜZ PARLAK RULO LEVHALARI
- ❖ LEVHA KESİM - BÜKÜM (ÖZEL ÖLÇÜLERİNİZDE)
- ❖ DELİKLİ ve DEKORATİF TELLER
- ❖ PLEXI - FOLYO - DEKOTE - POLYCARBON - KOMPOZİT VB.

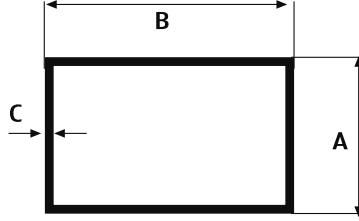

ALÜMİNYUM KUTU (OS.K1 - OS.K158)



KOD NO.	A (mm)	B (mm)	C (mm)	Gramaj (Kg/m)
OS.K1	8	8	1	0.076
OS.K2	6	12	1.2	0.206
OS.K3	7	16	2	0.221
OS.K4	9	20	1.2	0.103
OS.K5	10	10	1.2	0.216
OS.K6	10	16	2	0.239
OS.K7	10	20	1.5	0.219
OS.K8	10	20	2	0.281
OS.K9	10	25	1.5	0.261
OS.K10	10	30	1.5	0.301
OS.K11	10	35	1.2	0.276
OS.K12	12	12	1	0.118
OS.K13	12	12	2	0.214
OS.K14	12	14	1	0.129
OS.K15	12	18	1	0.151
OS.K16	14	18	0.8	0.131
OS.K17	15	15	1	0.122
OS.K18	15	15	1.05	0.160
OS.K19	15	25	1.02	0.243
OS.K20	15	30	1.25	0.288
OS.K21	15	30	2	0.451
OS.K22	15	40	2	0.553
OS.K24	15	50	2.5	0.791
OS.K25	15	100	1	0.613
OS.K26	15.8	43.5	1	0.353
OS.K27	16	16	0.8	0.132
OS.K28	16	16	2	0.305
OS.K29	16	34	1.5	0.378
OS.K30	17	17	1	0.172
OS.K31	17	17	2.5	0.401

KOD NO.	A (mm)	B (mm)	C (mm)	Gramaj (Kg/m)
OS.K32	17	25	1	0.227
OS.K33	17	25	1.5	0.317
OS.K34	17	25	2	0.426
OS.K35	18	18	1.9	0.304
OS.K36	20	20	0.9	0.185
OS.K37	20	20	2	0.390
OS.K38	20	30	1	0.261
OS.K39	20	30	2	0.498
OS.K40	20	40	0.9	0.281
OS.K41	20	40	1	0.314
OS.K42	20	40	1.5	0.460
OS.K43	20	40	2	0.607
OS.K44	20	40	3	0.878
OS.K45	20	50	1.6	0.539
OS.K46	20	50	2	0.715
OS.K47	20	50	2.5	0.881
OS.K48	20	60	1.2	0.500
OS.K49	20	60	2	0.821
OS.K50	20	80	1.1	0.582
OS.K51	20	100	1	0.641
OS.K52	20	100	2	1.257
OS.K53	22	28	1.5	0.379
OS.K54	23	58	1.35	0.556
OS.K55	25	25	1.2	0.309
OS.K56	25	25	2	0.499
OS.K57	25	30	1.1	0.314
OS.K58	25	35	2	0.411
OS.K59	25	40	2	0.661
OS.K60	25	50	2	0.795
OS.K61	25	60	3	1.291



OSMANLI
ALÜMİNYUM SAN. ve TİC. LTD. ŞTİ.

- ❖ ÖZEL EBATLARDA BORU, KUTU, LAMA, KÖŞEBENT ÇEŞİTLERİ
- ❖ AYDINLATMA ve REKLAM PROFİLLERİ
- ❖ SOĞUTUCU ve LED PROFİLLERİ
- ❖ MOBİLYA ve SANAYİ PROFİLLERİ
- ❖ ÖZEL KALIP ÇİZİMLERİ ve İMALATI
- ❖ ELOKSALLI ve PRES PLAKA LEVHALARI
- ❖ GOFRAJLI ve DÜZ PARLAK RULO LEVHALARI
- ❖ LEVHA KESİM - BÜKÜM (ÖZEL ÖLÇÜLERİNİZDE)
- ❖ DELİKLİ ve DEKORATİF TELLER
- ❖ PLEXI - FOLYO - DEKOTE - POLYCARBON - KOMPOZİT VB.

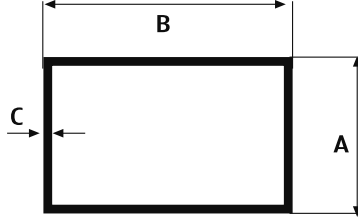

ALÜMİNYUM KUTU (OS.K1 - OS.K158)



KOD NO.	A (mm)	B (mm)	C (mm)	Gramaj (Kg/m)
OS.K62	25	90	91	0.633
OS.K63	25	140	2	1.746
OS.K64	27	85	1.5	0.921
OS.K65	27.5	27.5	1.4	0.396
OS.K66	28	68	1	0.506
OS.K67	28	68	1	0.509
OS.K68	29	69	2	1.018
OS.K69	30	30	1	0.356
OS.K70	30	30	2	0.607
OS.K71	30	30	5	1.355
OS.K72	30	30	2.5	0.810
OS.K73	30	30	3	0.878
OS.K74	30	40	1	0.350
OS.K75	30	40	2	0.715
OS.K76	30	40	3	1.041
OS.K77	30	50	2	0.823
OS.K78	30	50	4	1.541
OS.K79	30	60	2	0.932
OS.K80	30	60	3	1.376
OS.K81	30	70	1.1	0.583
OS.K82	30	80	1.8	0.585
OS.K83	30	80	4	2.221
OS.K84	31	90	1.2	0.771
OS.K85	32	71	0.8	0.434
OS.K86	35	32	2	0.613
OS.K87	35	75	1.1	0.625
OS.K88	35	35	1.5	0.545
OS.K89	35	50	1.5	0.667
OS.K90	38	55	2	0.915
OS.K92	38	48	1	0.455

KOD NO.	A (mm)	B (mm)	C (mm)	Gramaj (Kg/m)
OS.K93	38	48	2	0.889
OS.K94	40	40	1	0.422
OS.K95	40	40	2	0.821
OS.K96	40	40	3	1.203
OS.K97	40	40	6	2.211
OS.K98	40	50	0.95	0.453
OS.K99	40	50	2	0.932
OS.K100	40	60	1.2	0.634
OS.K101	40	60	2	1.038
OS.K102	40	60	3	1.525
OS.K103	40	80	1.3	0.827
OS.K104	40	80	2	1.257
OS.K105	40	80	3	1.854
OS.K106	40	80	6	3.512
OS.K107	40	100	2	1.474
OS.K108	40	100	3	2.178
OS.K109	40	120	1.7	1.428
OS.K110	40	160	2	2.115
OS.K111	43	170	3	3.371
OS.K112	45	45	2	0.932
OS.K113	45	90	2	1.421
OS.K114	45	175	3	3.595
OS.K115	45	175	5	5.881
OS.K116	50	100	2	1.580
OS.K117	50	50	2	1.040
OS.K118	50	50	3	1.528
OS.K119	50	50	4	1.995
OS.K120	50	50	5	2.440
OS.K121	50	65	2	1.185
OS.K122	50	80	1.2	0.831



OSMANLI
ALÜMİNYUM SAN. ve TİC. LTD. ŞTİ.

- ❖ ÖZEL EBATLARDA BORU, KUTU, LAMA, KÖŞEBENT ÇEŞİTLERİ
- ❖ AYDINLATMA ve REKLAM PROFİLLERİ
- ❖ SOĞUTUCU ve LED PROFİLLERİ
- ❖ MOBİLYA ve SANAYİ PROFİLLERİ
- ❖ ÖZEL KALIP ÇİZİMLERİ ve İMALATI
- ❖ ELOKSALLI ve PRES PLAKA LEVHALARI
- ❖ GOFRAJLI ve DÜZ PARLAK RULO LEVHALARI
- ❖ LEVHA KESİM - BÜKÜM (ÖZEL ÖLÇÜLERİNİZDE)
- ❖ DELİKLİ ve DEKORATİF TELLER
- ❖ PLEXI - FOLYO - DEKOTE - POLYCARBON - KOMPOZİT VB.

ALÜMİNYUM DÜZ LEVHA

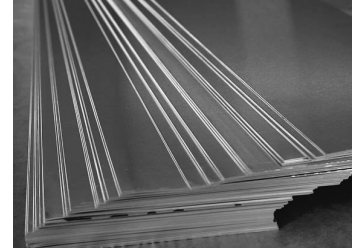

KALINLIK (mm)	GENİŞLİK (cm)	UZUNLUK (cm)	AĞIRLIK
0,30	100	200	1.7
0,40	100	200	2.2
0,50	100	200	2.7
0,60	100	200	3.3
0,70	100	200	3.8
0,80	100	200	4.5
1,00	100	200	5.5
1,20	100	200	6.5
1,50	100	200	8.2
2,00	100	200	11
2,50	100	200	13.5
3,00	100	200	16.5
4,00	100	200	22
5,00	100	200	27.5
6,00	100	200	32.5
8,00	100	200	44
10,00	100	200	54.5

KALINLIK (mm)	GENİŞLİK (cm)	UZUNLUK (cm)	AĞIRLIK
1,00	150	300	12.5
1,20	150	300	15
1,50	150	300	18.5
2,00	150	300	24.5
2,50	150	300	30.5
3,00	150	300	36.5
4,00	150	300	49
4.50	150	300	55
5,00	150	300	61
6,00	150	300	73.5
8,00	150	300	97.5

KALINLIK (mm)	GENİŞLİK (cm)	UZUNLUK (cm)	AĞIRLIK
1,00	125	250	8.5
1,20	125	250	10.2
1,50	125	250	13
2,00	125	250	17
2,50	125	250	21.2
3,00	125	250	25.5
4,00	125	250	34
5,00	125	250	42.5
6,00	125	250	51
8,00	125	250	68
10,00	125	250	85

KALINLIK (mm)	GENİŞLİK (cm)	UZUNLUK (cm)	AĞIRLIK
2.00	100	300	16.7
2.00	200	300	33.4
2.00	200	400	44.5



OSMANLI
ALÜMİNYUM SAN. ve TİC. LTD. ŞTİ.

- ❖ ÖZEL EBATLARDA BORU, KUTU, LAMA, KÖŞEBENT ÇEŞİTLERİ
- ❖ AYDINLATMA ve REKLAM PROFİLLERİ
- ❖ SOĞUTUCU ve LED PROFİLLERİ
- ❖ MOBİLYA ve SANAYİ PROFİLLERİ
- ❖ ÖZEL KALIP ÇİZİMLERİ ve İMALATI
- ❖ ELOKSALLI ve PRES PLAKA LEVHALARI
- ❖ GOFRAJLI ve DÜZ PARLAK RULO LEVHALARI
- ❖ LEVHA KESİM - BÜKÜM (ÖZEL ÖLÇÜLERİNİZDE)
- ❖ DELİKLİ ve DEKORATİF TELLER
- ❖ PLEXI - FOLYO - DEKOTE - POLYCARBON - KOMPOZİT VB.

ALÜMİNYUM ÇETE LEVHA

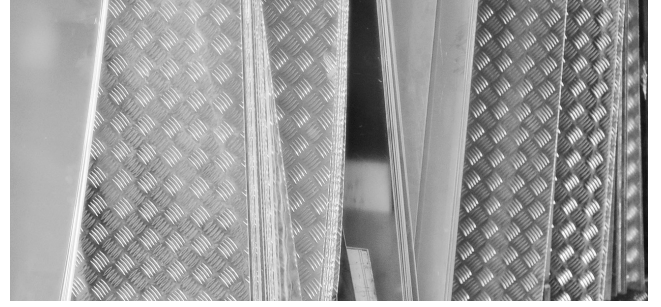

KOD NO.	GENİŞLİK	UZUNLUK	AĞIRLIK
1.2mmx2.5mm	100	200	8
1.5mmx2.5mm	100	200	11
2mmx3mm	100	200	13
3mmx4mm	100	200	17
5mmx6mm	100	200	22

KOD NO.	GENİŞLİK	UZUNLUK	AĞIRLIK
1.2mmx2.2mm	125	250	13
1.5mmx2.5mm	125	250	15
2mmx3mm	125	250	20
3mmx4mm İNCE	125	250	28
3mmx4mm KALIN	125	250	36
4mmX5mm	125	250	40

KOD NO.	GENİŞLİK	UZUNLUK	AĞIRLIK
1.5mmx2.5mm	150	300	22
3mmx4mm	150	300	34

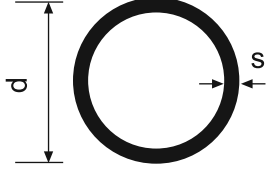

YUVARLAK BORULAR (OS.B1 - OS.B189)



KOD NO.	D (mm.)	S (mm.)	Gramaj (Kg./m.)
OS.B1	6.5	1	0.047
OS.B2	7	1	0.051
OS.B3	7.5	1	0.055
OS.B4	8	1	0.059
OS.B5	6	1	0.068
OS.B6	10	1	0.070
OS.B7	10	1.5	0.108
OS.B8	10	3.75	0.201
OS.B9	12	1	0.95
OS.B10	12	1.5	0.134
OS.B11	12	2	0.171
OS.B12	12	4	0.281
OS.B13	12	4.75	0.292
OS.B14	13	1	0.102
OS.B15	13	1.5	0.146
OS.B16	13	2.5	0.221
OS.B17	13	4	0.306
OS.B18	14	1	0.111
OS.B19	14	2	0.205
OS.B20	15	1	0.121
OS.B21	15.3	1.65	0.192
OS.B22	15.8	2	0.234
OS.B24	16	1	0.127
OS.B25	16	1.5	0.191
OS.B26	16	2	0.238
OS.B27	16	2.5	0.287
OS.B28	16	4	0.422
OS.B29	18	1.3	0.186
OS.B30	18	2.5	0.341
OS.B31	19	1.2	0.188

KOD NO.	D (mm.)	S (mm.)	Gramaj (Kg./m.)
OS.B32	20	1.1	0.177
OS.B33	20	1.8	0.282
OS.B34	20	3	0.434
OS.B35	20	6.5	0.748
OS.B36	21	2	0.321
OS.B37	22	1.2	0.221
OS.B38	22	1.5	0.213
OS.B39	22	2	0.338
OS.B40	22	4	0.612
OS.B41	22	6	0.813
OS.B42	23	1	0.187
OS.B43	23	1.25	0.237
OS.B44	23	1.5	0.274
OS.B45	24	1	0.177
OS.B46	25	1	0.204
OS.B47	25	1.5	0.301
OS.B48	25	1	0.405
OS.B49	25	1	0.478
OS.B50	25	1.5	0.561
OS.B51	25	4	0.715
OS.B52	25.5	4.5	0.805
OS.B53	25.5	6	0.996
OS.B54	27	1.5	0.325
OS.B55	26	1	0.212
OS.B56	26	1.5	0.312
OS.B57	28	1	0.230
OS.B58	28	1.2	0.273
OS.B59	28	1.5	0.339
OS.B60	29.5	1.25	0.301
OS.B61	30	1	0.247

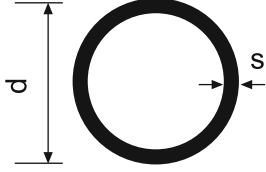

YUVARLAK BORULAR (OS.B1 - OS.B189)



KOD NO.	D (mm.)	S (mm.)	Gramaj (Kg./m.)
OS.B62	30	1.5	0.363
OS.B63	30	2	0.493
OS.B64	30	2.5	0.585
OS.B65	30	4	0.885
OS.B66	30	5	1.064
OS.B67	30	8	1.498
OS.B68	30	10.5	1.703
OS.B69	32	1	0.264
OS.B70	32	1.5	0.402
OS.B71	32	2	0.511
OS.B72	33	2	0.525
OS.B73	33	3	0.764
OS.B74	34	4	1.021
OS.B75	35	1.5	0.428
OS.B76	35	2.5	0.691
OS.B77	35	3	0.817
OS.B78	36	3	0.871
OS.B79	36	5	1.321
OS.B80	38	1	0.315
OS.B81	40	1	0.341
OS.B82	40	1.5	0.505
OS.B83	40	2	0.647
OS.B84	40	2.5	0.798
OS.B85	40	3	0.946
OS.B86	40	5	1.490
OS.B87	40	8	2.179
OS.B88	40.2	15.1	3.226
OS.B89	41	1	0.349
OS.B90	42	1	0.349
OS.B92	42	4	1.295

KOD NO.	D (mm.)	S (mm.)	Gramaj (Kg./m.)
OS.B93	42	5	1.575
OS.B94	44	2	0.715
OS.B95	45	2.5	0.905
OS.B96	45	9	2.851
OS.B97	50	1	0.417
OS.B98	50	1.5	0.619
OS.B99	50	2	0.817
OS.B100	50	2.5	1.011
OS.B101	50	3	1.200
OS.B102	50	4	1.619
OS.B103	50	5	1.916
OS.B104	50	6	2.322
OS.B105	50	10	3.519
OS.B106	51	1.5	0.632
OS.B107	52	11	3.871
OS.B108	52	2	0.873
OS.B109	53	5.8	2.357
OS.B110	53	1.5	0.686
OS.B111	54	8.5	3.219
OS.B112	54	1.5	0.693
OS.B113	54.2	5	2.087
OS.B114	55	2	0.889
OS.B115	55	2.3	1.033
OS.B116	55	6	2.504
OS.B117	55	10	3.817
OS.B118	56	14	4.891
OS.B119	57.5	2	0.913
OS.B120	60	2.5	1.171
OS.B121	60	1	0.500
OS.B122	60	2	0.978

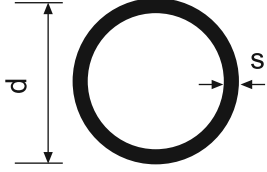

YUVARLAK BORULAR (OS.B1 - OS.B189)



KOD NO.	D (mm.)	S (mm.)	Gramaj (Kg./m.)
OS.B123	60	2.5	1.22
OS.B124	60	5	2.341
OS.B125	60	6	2.851
OS.B126	60	10	4.261
OS.B127	60	20	7.037
OS.B128	65	2.5	1.331
OS.B129	66	1.5	0.821
OS.B130	70	1.5	0.904
OS.B131	70	5	3.022
OS.B132	70	7	3.741
OS.B133	70	12.5	6.119
OS.B134	70	15	6.998
OS.B135	70	22.5	9.099
OS.B136	72.1	15.9	7.608
OS.B137	75	2	1.244
OS.B138	75	2.5	1.536
OS.B139	75	7.5	4.339
OS.B140	79.3	14.8	8.127
OS.B141	80	2	1.372
OS.B142	80	2.5	1.644
OS.B143	82	3	0.195
OS.B144	82	6	3.880
OS.B145	85	12	7.122
OS.B146	90	2.5	1.756
OS.B147	90	2	1.548
OS.B148	90	2.5	1.924
OS.B149	90	5	3.618
OS.B150	90	20	19.918
OS.B151	90	29.8	15.286
OS.B152	98	4	4.043

KOD NO.	D (mm.)	S (mm.)	Gramaj (Kg./m.)
OS.B153	100	1	0.840
OS.B154	100	1.5	1.253
OS.B155	100	2	1.724
OS.B156	100	2.5	2.075
OS.B157	100	3	2.477
OS.B158	100	5	4.043
OS.B160	100	15	10.855
OS.B161	103	1.1	0.954
OS.B162	105	2.5	2.617
OS.B163	105	7.5	6.226
OS.B164	107	1.5	1.078
OS.B165	107	3.5	3.084
OS.B166	110	1	1.101
OS.B167	110	5.4	4.827
OS.B168	112.5	6	5.441
OS.B169	115	3	2.851
OS.B170	115	5	4.778
OS.B171	120	2	2.009
OS.B172	120	5	4.877
OS.B173	120	30	22.986
OS.B174	125	1.3	1.364
OS.B175	125	2.5	2.694
OS.B176	130	10	10.216
OS.B177	132	2	2.122
OS.B178	135	3	3.371
OS.B179	140	4	4.631
OS.B180	140	7.5	8.47
OS.B181	150	2.3	2.91
OS.B182	150	2.5	3.01
OS.B183	154	11	13.341
OS.B184	155	5	6.385
OS.B185	160	1.8	2.601
OS.B186	160	3	4.501
OS.B187	180	3	4.52
OS.B188	200	3	5.10
OS.B189	200	4	6.80



OSMANLI
ALÜMİNYUM SAN. ve TİC. LTD. ŞTİ.

- ❖ ÖZEL EBATLARDA BORU, KUTU, LAMA, KÖŞEBENT ÇEŞİTLERİ
- ❖ AYDINLATMA ve REKLAM PROFİLLERİ
- ❖ SOĞUTUCU ve LED PROFİLLERİ
- ❖ MOBİLYA ve SANAYİ PROFİLLERİ
- ❖ ÖZEL KALIP ÇİZİMLERİ ve İMALATI
- ❖ ELOKSALLI ve PRES PLAKA LEVHALARI
- ❖ GOFRAJLI ve DÜZ PARLAK RULO LEVHALARI
- ❖ LEVHA KESİM - BÜKÜM (ÖZEL ÖLÇÜLERİNİZDE)
- ❖ DELİKLİ ve DEKORATİF TELLER
- ❖ PLEXI - FOLYO - DEKOTE - POLYCARBON - KOMPOZİT VB.

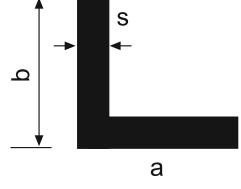

ALÜMİNYUM KÖŞEBENT (OS.KÖ1- OS.KÖ16)



KOD NO.	A (mm)	B (mm)	C (mm)	Gramaj (Kg/m)
OS.KÖ1	5	15	2	0.095
OS.KÖ2	5	20	1.2	0.077
OS.KÖ3	5	40	1.2	0.142
OS.KÖ4	5	60	1.3	0.224
OS.KÖ5	5	80	1.1	0.251
OS.KÖ6	5	100	2	0.558
OS.KÖ7	5	150	1.7	0.706
OS.KÖ8	10	10	1.2	0.061
OS.KÖ9	10	15	1	0.065
OS.KÖ10	10	20	1	0.078
OS.KÖ11	10	25	1.2	0.112
OS.KÖ12	10	30	1	0.105
OS.KÖ13	10	30	2	0.205
OS.KÖ14	10	40	2	0.259
OS.KÖ15	10	50	1	0.161
OS.KÖ16	12	20	1.2	0.101
OS.KÖ17	14	24	2	0.173
OS.KÖ18	15	15	1.2	0.095
OS.KÖ19	15	15	2	0.151
OS.KÖ20	15	20	2	0.178
OS.KÖ21	15	25	2.5	0.253
OS.KÖ22	15	25	5	0.473
OS.KÖ23	15	30	1.2	0.142
OS.KÖ24	15	30	2	0.233
OS.KÖ25	15	40	2	0.286
OS.KÖ26	18	26	8	0.781
OS.KÖ27	18	100	1.6	0.505
OS.KÖ28	20	20	1.1	0.116
OS.KÖ29	20	20	1.3	0.135
OS.KÖ30	20	20	2	0.206

KOD NO.	A (mm)	B (mm)	C (mm)	Gramaj (Kg/m)
OS.KÖ31	20	20	3	0.301
OS.KÖ32	20	20	8	0.693
OS.KÖ33	20	25	1.3	0.155
OS.KÖ34	20	30	1	0.132
OS.KÖ35	20	40	1.2	0.191
OS.KÖ36	20	40	2	0.156
OS.KÖ37	20	40	3	0.463
OS.KÖ38	20	40	5	0.745
OS.KÖ39	20	50	1.2	0.223
OS.KÖ40	20	60	1.2	0.236
OS.KÖ41	20	60	1.6	0.339
OS.KÖ42	20	60	2	0.424
OS.KÖ43	20	70	2	0.477
OS.KÖ44	20	80	1.2	0.321
OS.KÖ45	20	80	1.5	0.401
OS.KÖ46	20	100	1.2	0.385
OS.KÖ47	20	150	1.8	0.821
OS.KÖ48	22	35	2	0.298
OS.KÖ49	24	27	2	0.251
OS.KÖ50	25	25	1.1	0.146
OS.KÖ51	25	25	1.2	0.157
OS.KÖ52	25	25	2	0.261
OS.KÖ53	25	25	3	0.381
OS.KÖ54	25	25	5	0.611
OS.KÖ55	25	35	2	0.313
OS.KÖ56	25	40	5	0.811
OS.KÖ57	25	50	3,	0.573
OS.KÖ58	25	80	1.5	0.421
OS.KÖ60	25	30	1	0.161
OS.KÖ61	30	30	1.1	0.176



OSMANLI
ALÜMİNYUM SAN. ve TİC. LTD. ŞTİ.

- ❖ ÖZEL EBATLARDA BORU, KUTU, LAMA, KÖŞEBENT ÇEŞİTLERİ
- ❖ AYDINLATMA ve REKLAM PROFİLLERİ
- ❖ SOĞUTUCU ve LED PROFİLLERİ
- ❖ MOBİLYA ve SANAYİ PROFİLLERİ
- ❖ ÖZEL KALIP ÇİZİMLERİ ve İMALATI
- ❖ ELOKSALLI ve PRES PLAKA LEVHALARI
- ❖ GOFRAJLI ve DÜZ PARLAK RULO LEVHALARI
- ❖ LEVHA KESİM - BÜKÜM (ÖZEL ÖLÇÜLERİNİZDE)
- ❖ DELİKLİ ve DEKORATİF TELLER
- ❖ PLEXI - FOLYO - DEKOTE - POLYCARBON - KOMPOZİT VB.

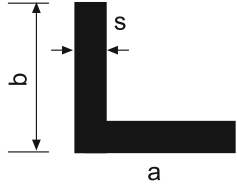

ALÜMİNYUM KÖŞEBENT (OS.KÖ1- OS.KÖ116)



KOD NO.	A (mm)	B (mm)	C (mm)	Gramaj (Kg/m)
OS.KÖ62	30	30	1.3	0.206
OS.KÖ63	30	30	2	0.314
OS.KÖ64	30	30	3	0.462
OS.KÖ65	30	30	4	0.605
OS.KÖ66	30	45	2.8	0.546
OS.KÖ67	30	50	1.5	0.321
OS.KÖ68	30	70	2	0.529
OS.KÖ69	32	32	2.5	0.416
OS.KÖ70	40	40	1	0.235
OS.KÖ71	40	40	2	0.422
OS.KÖ72	40	40	2.5	0.525
OS.KÖ73	40	40	3	0.624
OS.KÖ74	40	40	4	0.821
OS.KÖ75	40	40	6	1.203
OS.KÖ76	40	50	5	1.151
OS.KÖ77	40	60	1.5	0.411
OS.KÖ78	40	60	2	0.531
OS.KÖ79	40	60	4	1.041
OS.KÖ80	40	60	6	1.221
OS.KÖ81	40	65	5	1.354
OS.KÖ82	40	90	1.4	0.486
OS.KÖ83	40	120	2	0.853
OS.KÖ84	45	45	2	0.476
OS.KÖ85	45	60	2.3	0.637
OS.KÖ86	50	50	1.2	0.322
OS.KÖ87	50	50	2	0.531
OS.KÖ88	50	50	4	1.037
OS.KÖ89	50	50	5	1.282
OS.KÖ90	50	70	2.5	1.611

KOD NO.	A (mm)	B (mm)	C (mm)	Gramaj (Kg/m)
OS.KÖ91	50	70	4	1.256
OS.KÖ93	53	120	3	1.387
OS.KÖ94	54	120	3	1.395
OS.KÖ95	54	140	3	1.558
OS.KÖ96	54	160	3	1.721
OS.KÖ97	60	60	1.5	0.481
OS.KÖ98	60	60	2	0.638
OS.KÖ99	60	60	3	0.948
OS.KÖ100	60	60	4	1.253
OS.KÖ101	60	60	6	1.854
OS.KÖ102	60	70	12	3.823
OS.KÖ103	60	100	10	4.051
OS.KÖ104	70	70	2	0.745
OS.KÖ105	70	70	8	2.851
OS.KÖ106	80	80	2	0.826
OS.KÖ107	80	80	5	2.092
OS.KÖ108	80	80	6	2.504
OS.KÖ109	80	80	8	3.301
OS.KÖ110	80	80	10	4.065
OS.KÖ111	120	120	10	5.131
OS.KÖ112	150	150	5	3.172
OS.KÖ113	100	100	4	2.117
OS.KÖ114	100	100	10	5.131
OS.KÖ115	150	150	10	6.481
OS.KÖ116	200	200	10	7.831



OSMANLI
ALÜMİNYUM SAN. ve TİC. LTD. ŞTİ.

- ❖ ÖZEL EBATLARDA BORU, KUTU, LAMA, KÖŞEBENT ÇEŞİTLERİ
- ❖ AYDINLATMA ve REKLAM PROFİLLERİ
- ❖ SOĞUTUCU ve LED PROFİLLERİ
- ❖ MOBİLYA ve SANAYİ PROFİLLERİ
- ❖ ÖZEL KALIP ÇİZİMLERİ ve İMALATI
- ❖ ELOKSALLI ve PRES PLAKA LEVHALARI
- ❖ GOFRAJLI ve DÜZ PARLAK RULO LEVHALARI
- ❖ LEVHA KESİM - BÜKÜM (ÖZEL ÖLÇÜLERİNİZDE)
- ❖ DELİKLİ ve DEKORATİF TELLER
- ❖ PLEXI - FOLYO - DEKOTE - POLYCARBON - KOMPOZİT VB.

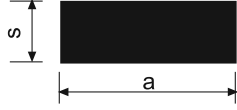

ALÜMİNYUM LAMA (OS.L1 - OS.L167)

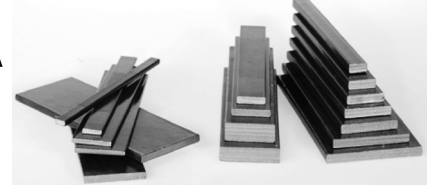

KOD NO.	D (mm.)	S (mm.)	Gramaj (Kg./m.)
OS.L1	10	1.5	0.041
OS.L2	10	3.	0.081
OS.L3	10	10	0.271
OS.L4	12	1.5	0.049
OS.L5	12	4	0.131
OS.L6	12	5	0.163
OS.L7	12	12	0.391
OS.L8	13	3	0.103
OS.L9	15	1.5	0.061
OS.L10	15	2	0.084
OS.L11	15	2.5	0.101
OS.L12	15	3	0.122
OS.L13	15	5	0.203
OS.L14	15	10	0.405
OS.L15	15	8	0.324
OS.L16	15.1	3	0.122
OS.L17	16	7	0.302
OS.L18	17	7	0.321
OS.L19	16.1	11	0.478
OS.L20	20	1.5	0.081
OS.L21	20	2	0.108
OS.L22	20	3	0.162
OS.L23	20	4	0.216
OS.L24	20	5	0.271
OS.L25	20	6	0.324
OS.L26	20	8	0.432
OS.L27	20	10	0.541
OS.L28	20	12	0.651
OS.L29	20	15	0.841
OS.L30	20.1	3.1	0.169

KOD NO.	D (mm.)	S (mm.)	Gramaj (Kg./m.)
OS.L31	21	14	0.794
OS.L32	21.3	5.3	0.305
OS.L33	21.5	5.5	0.319
OS.L34	25	2	0.141
OS.L35	25	2.5	0.169
OS.L36	25	3	0.202
OS.L37	25	4	0.271
OS.L38	25	5	0.338
OS.L39	25	6	0.405
OS.L40	25	10	0.675
OS.L41	25	15	1.012
OS.L42	25	20	1.351
OS.L43	26	2.5	1.671
OS.L44	26	7	0.491
OS.L45	26.3	6	0.426
OS.L46	30	2	0.162
OS.L47	30	3	0.243
OS.L48	30	4	0.324
OS.L49	30	5	0.405
OS.L50	30	6	0.486
OS.L51	30	7	0.567
OS.L52	30	8	0.648
OS.L53	30	10	0.811
OS.L54	30	15	1.215
OS.L55	30	16	1.296
OS.L57	30	25	2.025
OS.L58	34	8	0.737
OS.L59	35	3	0.284
OS.L60	35	5	0.472
OS.L61	35	6	0.567



OSMANLI
ALÜMİNYUM SAN. ve TİC. LTD .ŞTİ.

- ❖ ÖZEL EBATLARDA BORU, KUTU, LAMA, KÖŞEBENT ÇEŞİTLERİ
- ❖ AYDINLATMA ve REKLAM PROFİLLERİ
- ❖ SOĞUTUCU ve LED PROFİLLERİ
- ❖ MOBİLYA ve SANAYİ PROFİLLERİ
- ❖ ÖZEL KALIP ÇİZİMLERİ ve İMALATI
- ❖ ELOKSALLI ve PRES PLAKA LEVHALARI
- ❖ GOFRAJLI ve DÜZ PARLAK RULO LEVHALARI
- ❖ LEVHA KESİM - BÜKÜM (ÖZEL ÖLÇÜLERİNİZDE)
- ❖ DELİKLİ ve DEKORATİF TELLER
- ❖ PLEXI - FOLYO - DEKOTE - POLYCARBON - KOMPOZİT VB.

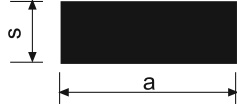

ALÜMİNYUM LAMA (OS.L1 - OS.L167)

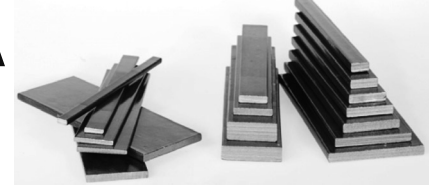

KOD NO.	D (mm.)	S (mm.)	Gramaj (Kg./m.)
OS.L62	35	17	1.606
OS.L63	36	2.9	0.282
OS.L64	37	1.5	0.151
OS.L65	40	2	0.216
OS.L66	40	3	0.324
OS.L67	40	4	0.432
OS.L68	40	5	0.541
OS.L69	40	6	0.648
OS.L70	40	7	0.759
OS.L71	40	8	0.864
OS.L72	40	10	1.081
OS.L73	40	15	1.621
OS.L74	40	20	2.161
OS.L75	40	25	2.701
OS.L76	40	30	3.601
OS.L77	50	3	0.405
OS.L78	50	5	0.675
OS.L79	50	8	1.081
OS.L80	50	10	1.351
OS.L81	50	15	2.025
OS.L82	50	20	2.701
OS.L83	50	25	3.375
OS.L84	50	30	4.051
OS.L85	50	35	4.725
OS.L86	50	40	5.401
OS.L87	50	100	14.001
OS.L88	55	8	1.193
OS.L89	60	3	0.486
OS.L90	60	4	0.648
OS.L91	60	5	0.811

KOD NO.	D (mm.)	S (mm.)	Gramaj (Kg./m.)
OS.L92	60	6	0.972
OS.L93	60	8	1.296
OS.L94	60	10	1.621
OS.L95	60	12	1.944
OS.L96	60	15	2.431
OS.L97	60	20	3.241
OS.L98	60	25	4.051
OS.L99	60	30	4.861
OS.L100	60	40	6.725
OS.L101	60	50	8.129
OS.L102	65	30	5.265
OS.L103	70	1.6	3.035
OS.L104	70	3	0.567
OS.L105	70	8	1.512
OS.L106	70	10	1.891
OS.L107	70	15	2.845
OS.L108	70	20	3.781
OS.L109	70	30	5.881
OS.L110	70	35	6.615
OS.L111	70	40	7.561
OS.L112	70	60	11.382
OS.L113	70	70	13.278
OS.L114	80	1.4	0.301
OS.L115	80	5	1.081
OS.L116	80	6	1.296
OS.L117	80	8	1.728
OS.L118	80	10	2.161
OS.L119	80	12	2.601
OS.L120	80	15	3.241
OS.L122	80	25	5.601



OSMANLI
ALÜMİNYUM SAN. ve TİC. LTD. ŞTİ.

- ❖ ÖZEL EBATLARDA BORU, KUTU, LAMA, KÖŞEBENT ÇEŞİTLERİ
- ❖ AYDINLATMA ve REKLAM PROFİLLERİ
- ❖ SOĞUTUCU ve LED PROFİLLERİ
- ❖ MOBİLYA ve SANAYİ PROFİLLERİ
- ❖ ÖZEL KALIP ÇİZİMLERİ ve İMALATI
- ❖ ELOKSALLI ve PRES PLAKA LEVHALARI
- ❖ GOFRAJLI ve DÜZ PARLAK RULO LEVHALARI
- ❖ LEVHA KESİM - BÜKÜM (ÖZEL ÖLÇÜLERİNİZDE)
- ❖ DELİKLİ ve DEKORATİF TELLER
- ❖ PLEXI - FOLYO - DEKOTE - POLYCARBON - KOMPOZİT VB.

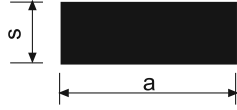

ALÜMİNYUM LAMA (OS.L1 - OS.L167)

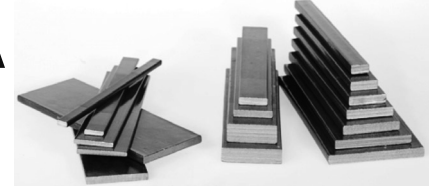

KOD NO.	D (mm.)	S (mm.)	Gramaj (Kg./m.)
OS.L123	80	30	6.701
OS.L124	80	40	8.672
OS.L125	80	50	10.801
OS.L126	80	60	12.96
OS.L127	90	4	0.975
OS.L128	90	6	1.464
OS.L129	90	15	3.645
OS.L130	90	20	4.878
OS.L131	90	30	7.291
OS.L132	100	2	0.541
OS.L133	100	3	0.811
OS.L134	100	4	1.084
OS.L135	100	5	1.351
OS.L136	100	6	1.621
OS.L137	100	7	1.897
OS.L138	100	8	2.161
OS.L139	100	10	2.701
OS.L140	100	12	3.577
OS.L141	100	15	4.051
OS.L142	100	20	5.401
OS.L143	100	25	7.001
OS.L144	100	30	8.101
OS.L145	110	3	0.891
OS.L146	110	6	1.789
OS.L147	110	8	2.376
OS.L148	110	20	5.941
OS.L149	120	3	0.972
OS.L150	120	10	3.241
OS.L151	120	15	4.861
OS.L152	120	20	6.481

KOD NO.	D (mm.)	S (mm.)	Gramaj (Kg./m.)
OS.L153	127	3	1.029
OS.L154	140	20	7.587
OS.L155	150	5	2.033
OS.L156	150	6	2.431
OS.L157	150	10	4.051
OS.L158	150	15	6.075
OS.L160	150	30	12.15
OS.L161	156	4	1.691
OS.L162	160	10	4.321
OS.L163	170	8	3.686
OS.L164	180	10	4.861
OS.L165	200	10	5.401
OS.L166	200	15	8.101
OS.L167	200	25	13.501



OSMANLI
ALÜMİNYUM SAN. ve TİC. LTD .ŞTİ.

- ❖ ÖZEL EBATLARDA BORU, KUTU, LAMA, KÖŞEBENT ÇEŞİTLERİ
- ❖ AYDINLATMA ve REKLAM PROFİLLERİ
- ❖ SOĞUTUCU ve LED PROFİLLERİ
- ❖ MOBİLYA ve SANAYİ PROFİLLERİ
- ❖ ÖZEL KALIP ÇİZİMLERİ ve İMALATI
- ❖ ELOKSALLI ve PRES PLAKA LEVHALARI
- ❖ GOFRAJLI ve DÜZ PARLAK RULO LEVHALARI
- ❖ LEVHA KESİM - BÜKÜM (ÖZEL ÖLÇÜLERİNİZDE)
- ❖ DELİKLİ ve DEKORATİF TELLER
- ❖ PLEXI - FOLYO - DEKOTE - POLYCARBON - KOMPOZİT VB.

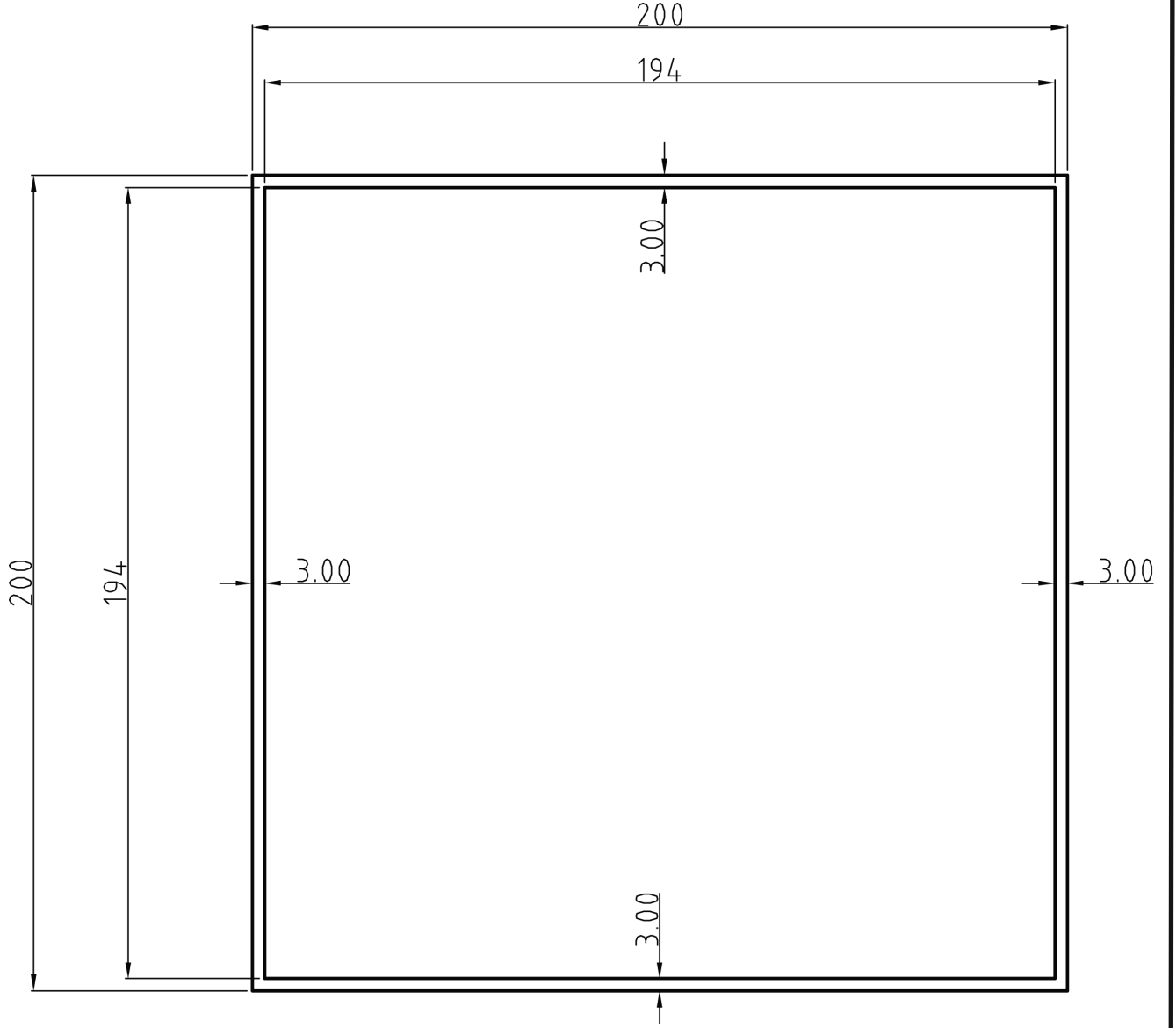

OSM7935
6.50 KG.



OSMANLI
ALÜMİNYUM SAN. ve TİC. LTD .ŞTİ.

- ❖ ÖZEL EBATLARDA BORU, KUTU, LAMA, KÖŞEBENT ÇEŞİTLERİ
- ❖ AYDINLATMA ve REKLAM PROFİLLERİ
- ❖ SOĞUTUCU ve LED PROFİLLERİ
- ❖ MOBİLYA ve SANAYİ PROFİLLERİ
- ❖ ÖZEL KALIP ÇİZİMLERİ ve İMALATI
- ❖ ELOKSALLI ve PRES PLAKA LEVHALARI
- ❖ GOFRAJLI ve DÜZ PARLAK RULO LEVHALARI
- ❖ LEVHA KESİM - BÜKÜM (ÖZEL ÖLÇÜLERİNİZDE)
- ❖ DELİKLİ ve DEKORATİF TELLER
- ❖ PLEXI - FOLYO - DEKOTE - POLYCARBON - KOMPOZİT VB.

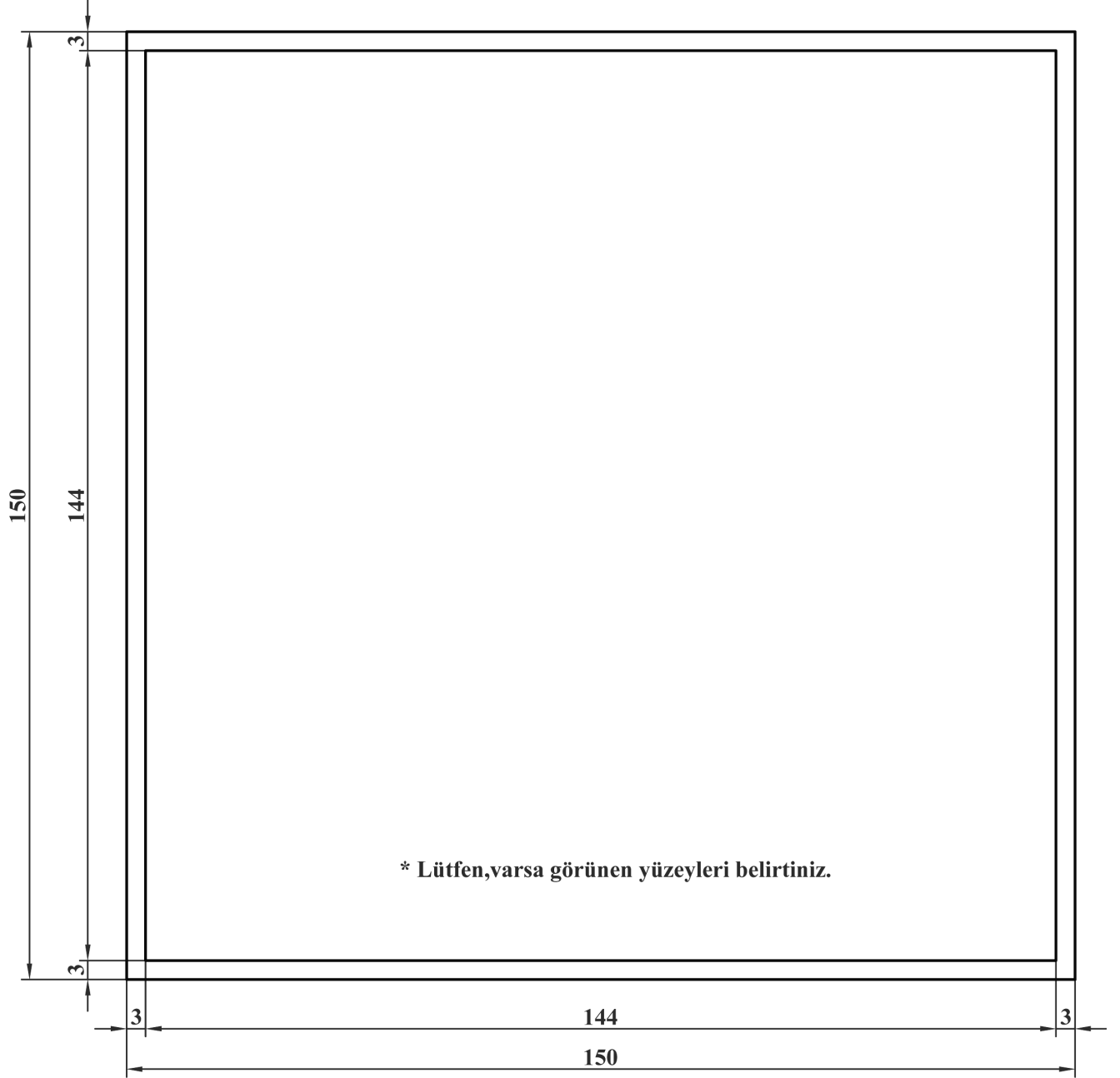

OSM13310
4.80 KG.



OSMANLI
ALÜMİNYUM SAN. ve TİC. LTD .ŞTİ.

- ❖ ÖZEL EBATLARDA BORU, KUTU, LAMA, KÖŞEBENT ÇEŞİTLERİ
- ❖ AYDINLATMA ve REKLAM PROFİLLERİ
- ❖ SOĞUTUCU ve LED PROFİLLERİ
- ❖ MOBİLYA ve SANAYİ PROFİLLERİ
- ❖ ÖZEL KALIP ÇİZİMLERİ ve İMALATI
- ❖ ELOKSALLI ve PRES PLAKA LEVHALARI
- ❖ GOFRAJLI ve DÜZ PARLAK RULO LEVHALARI
- ❖ LEVHA KESİM - BÜKÜM (ÖZEL ÖLÇÜLERİNİZDE)
- ❖ DELİKLİ ve DEKORATİF TELLER
- ❖ PLEXI - FOLYO - DEKOTE - POLYCARBON - KOMPOZİT VB.

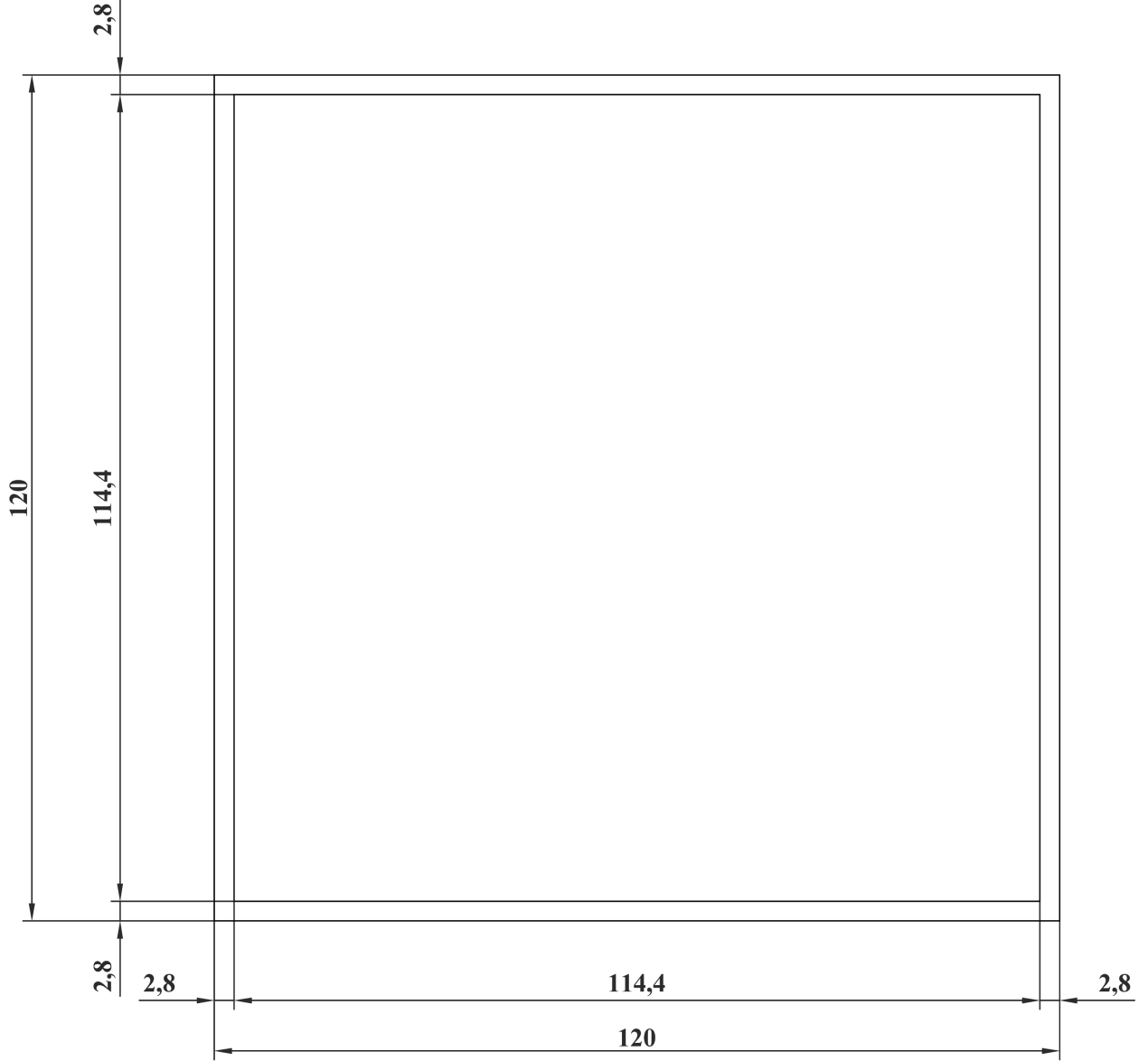

* Lütfen, varsa görünen yüzeyleri belirtiniz.

OSM13309
3.40 KG.



OSMANLI
ALÜMİNYUM SAN. ve TİC. LTD .ŞTİ.

- ❖ ÖZEL EBATLARDA BORU, KUTU, LAMA, KÖŞEBENT ÇEŞİTLERİ
- ❖ AYDINLATMA ve REKLAM PROFİLLERİ
- ❖ SOĞUTUCU ve LED PROFİLLERİ
- ❖ MOBİLYA ve SANAYİ PROFİLLERİ
- ❖ ÖZEL KALIP ÇİZİMLERİ ve İMALATI
- ❖ ELOKSALLI ve PRES PLAKA LEVHALARI
- ❖ GOFRAJLI ve DÜZ PARLAK RULO LEVHALARI
- ❖ LEVHA KESİM - BÜKÜM (ÖZEL ÖLÇÜLERİNİZDE)
- ❖ DELİKLİ ve DEKORATİF TELLER
- ❖ PLEXI - FOLYO - DEKOTE - POLYCARBON - KOMPOZİT VB.

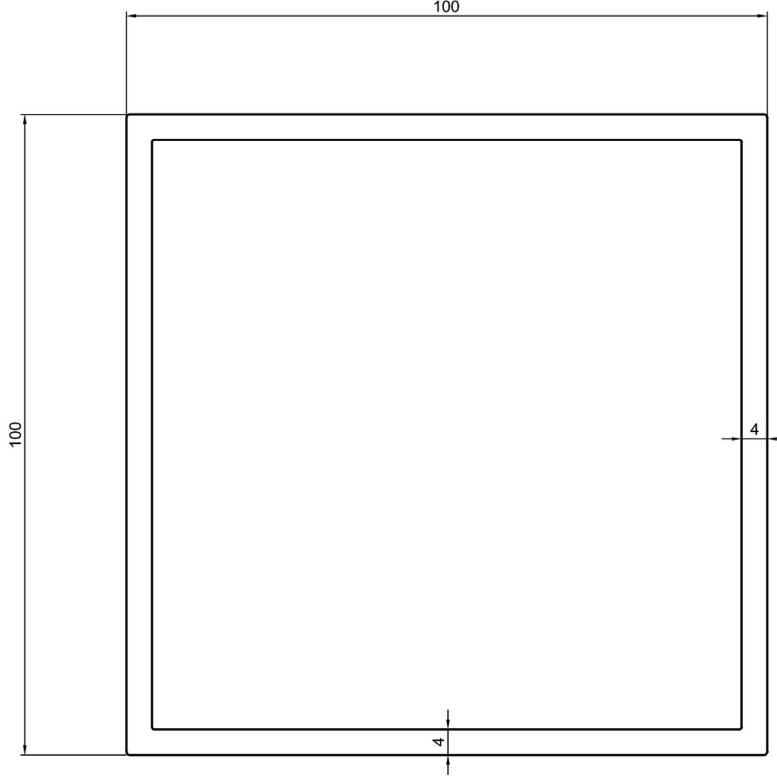

OSM1976
4.50 KG.

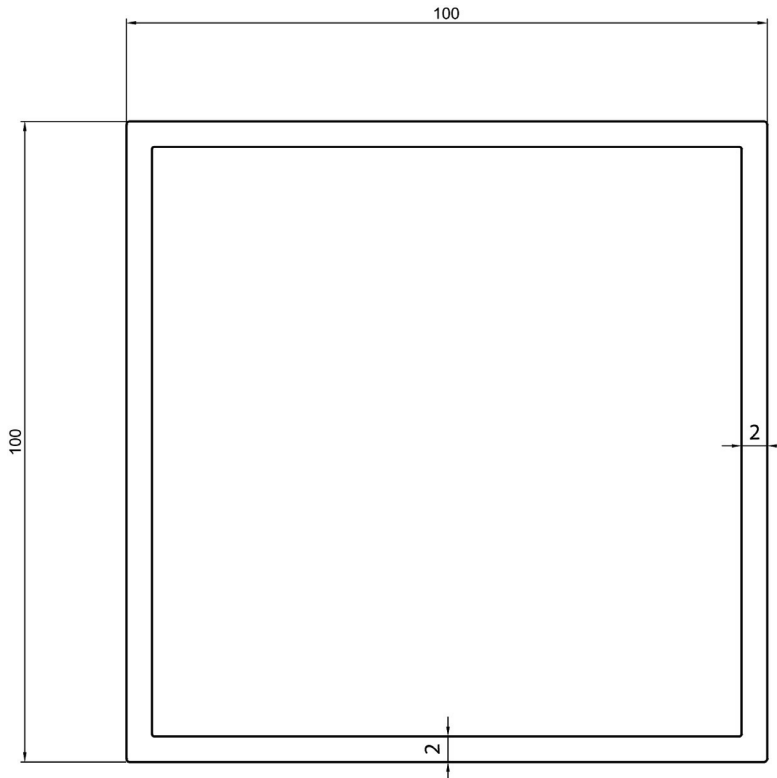

OSM1983
2.28 KG.



OSMANLI
ALÜMİNYUM SAN. ve TİC. LTD .ŞTİ.

- ❖ ÖZEL EBATLARDA BORU, KUTU, LAMA, KÖŞEBENT ÇEŞİTLERİ
- ❖ AYDINLATMA ve REKLAM PROFİLLERİ
- ❖ SOĞUTUCU ve LED PROFİLLERİ
- ❖ MOBİLYA ve SANAYİ PROFİLLERİ
- ❖ ÖZEL KALIP ÇİZİMLERİ ve İMALATI
- ❖ ELOKSALLI ve PRES PLAKA LEVHALARI
- ❖ GOFRAJLI ve DÜZ PARLAK RULO LEVHALARI
- ❖ LEVHA KESİM - BÜKÜM (ÖZEL ÖLÇÜLERİNİZDE)
- ❖ DELİKLİ ve DEKORATİF TELLER
- ❖ PLEXI - FOLYO - DEKOTE - POLYCARBON - KOMPOZİT VB.

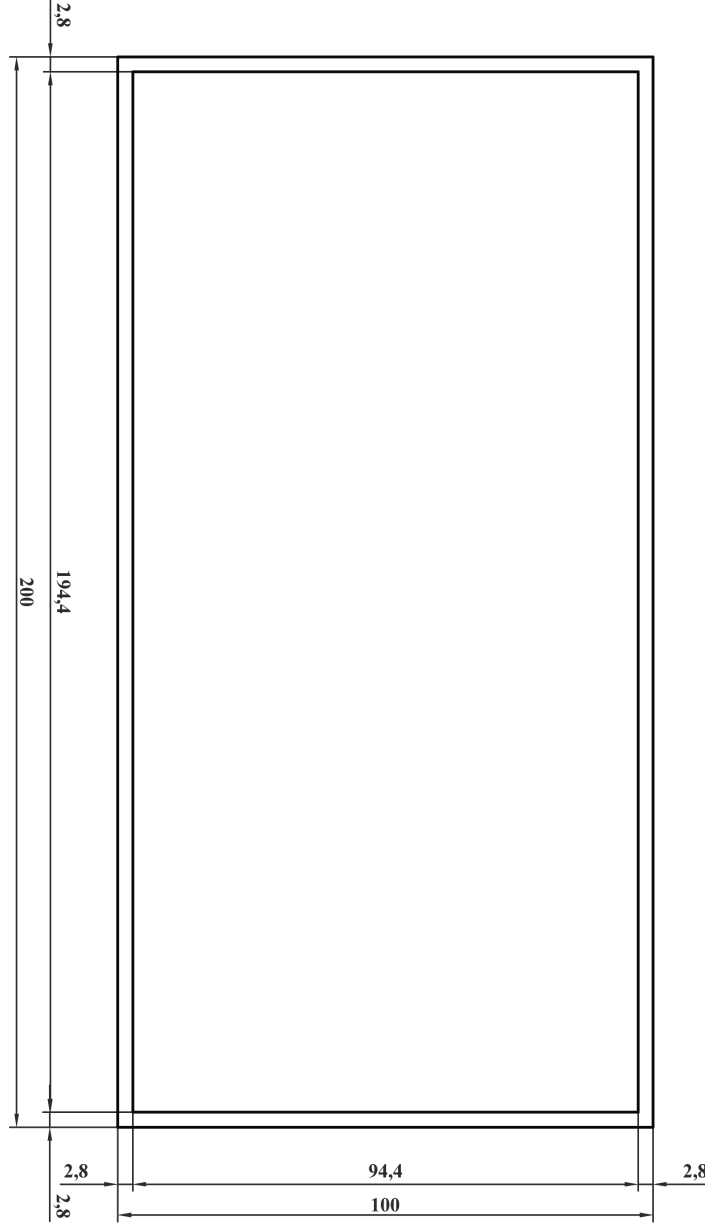

OSM13312
4.50 KG.



OSMANLI
ALÜMİNYUM SAN. ve TİC. LTD .ŞTİ.

- ❖ ÖZEL EBATLARDA BORU, KUTU, LAMA, KÖŞEBENT ÇEŞİTLERİ
- ❖ AYDINLATMA ve REKLAM PROFİLLERİ
- ❖ SOĞUTUCU ve LED PROFİLLERİ
- ❖ MOBİLYA ve SANAYİ PROFİLLERİ
- ❖ ÖZEL KALIP ÇİZİMLERİ ve İMALATI
- ❖ ELOKSALLI ve PRES PLAKA LEVHALARI
- ❖ GOFRAJLI ve DÜZ PARLAK RULO LEVHALARI
- ❖ LEVHA KESİM - BÜKÜM (ÖZEL ÖLÇÜLERİNİZDE)
- ❖ DELİKLİ ve DEKORATİF TELLER
- ❖ PLEXI - FOLYO - DEKOTE - POLYCARBON - KOMPOZİT VB.

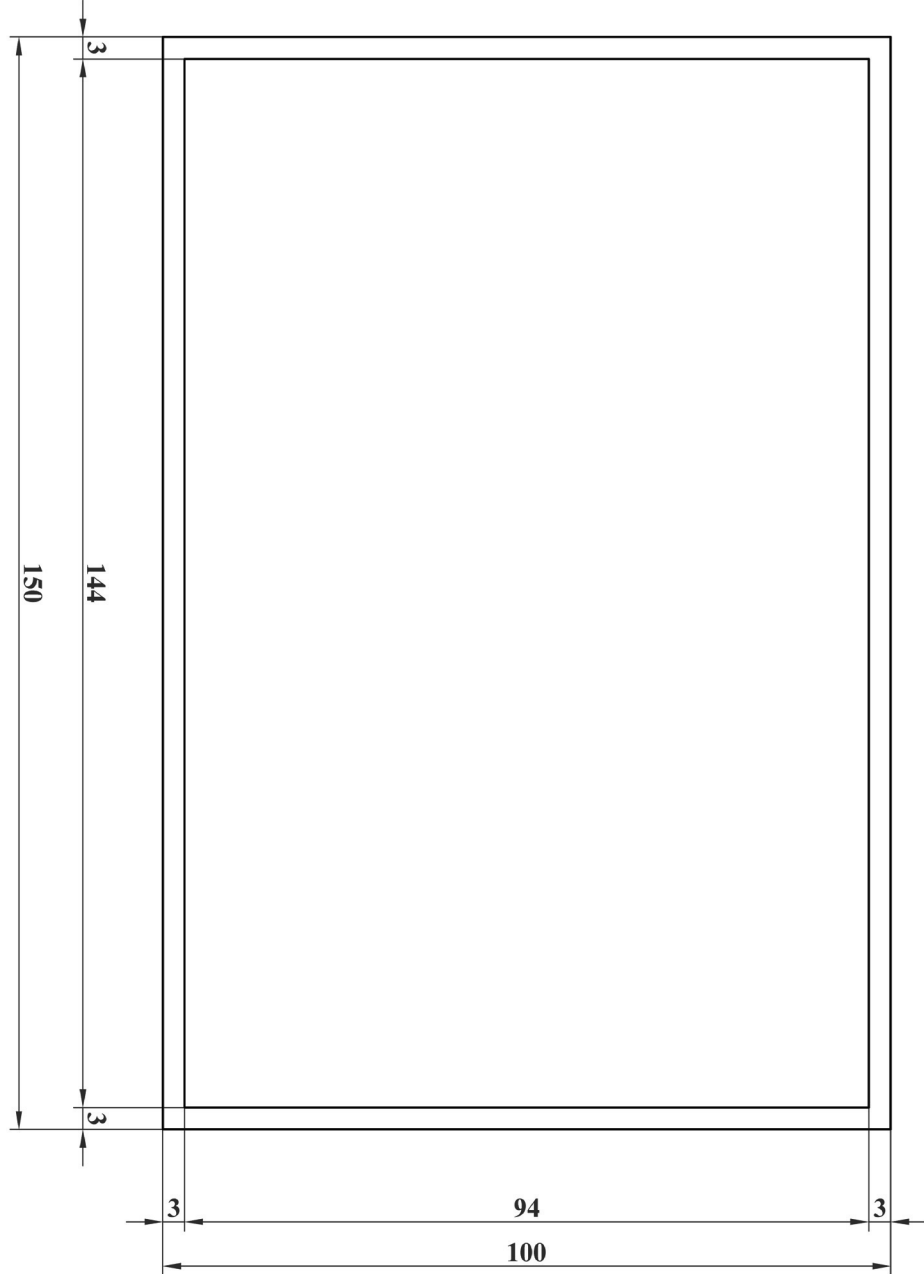

* Lütfen, varsa görünen yüzeyleri belirtiniz.

OSM13311
4.00 KG.



OSMANLI
ALÜMİNYUM SAN. ve TİC. LTD .ŞTİ.

- ❖ ÖZEL EBATLARDA BORU, KUTU, LAMA, KÖŞEBENT ÇEŞİTLERİ
- ❖ AYDINLATMA ve REKLAM PROFİLLERİ
- ❖ SOĞUTUCU ve LED PROFİLLERİ
- ❖ MOBİLYA ve SANAYİ PROFİLLERİ
- ❖ ÖZEL KALIP ÇİZİMLERİ ve İMALATI
- ❖ ELOKSALLI ve PRES PLAKA LEVHALARI
- ❖ GOFRAJLI ve DÜZ PARLAK RULO LEVHALARI
- ❖ LEVHA KESİM - BÜKÜM (ÖZEL ÖLÇÜLERİNİZDE)
- ❖ DELİKLİ ve DEKORATİF TELLER
- ❖ PLEXI - FOLYO - DEKOTE - POLYCARBON - KOMPOZİT VB.

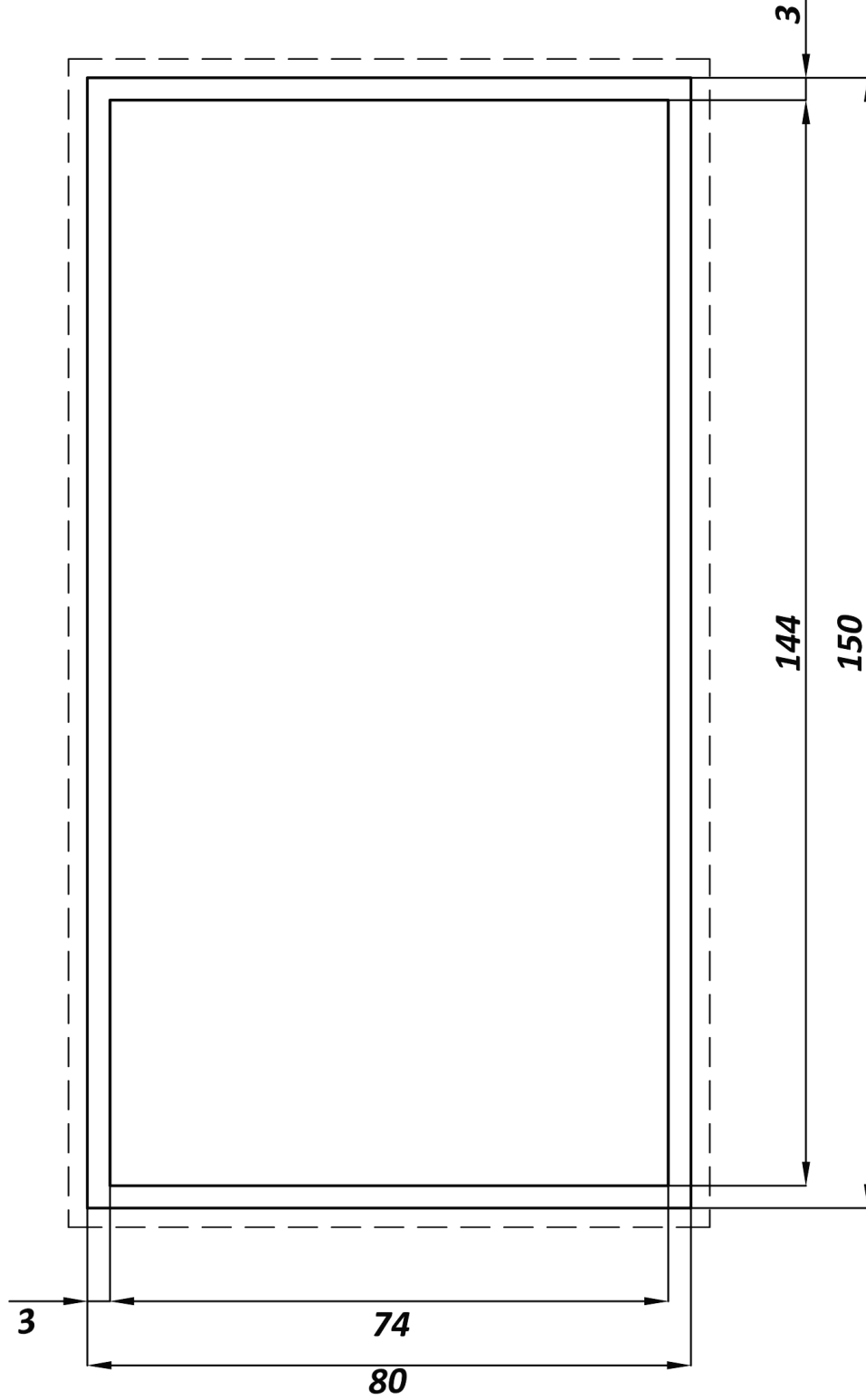

OSM1885
3.70 KG.



OSMANLI
ALÜMİNYUM SAN. ve TİC. LTD. ŞTİ.

- ❖ ÖZEL EBATLARDA BORU, KUTU, LAMA, KÖŞEBENT ÇEŞİTLERİ
- ❖ AYDINLATMA ve REKLAM PROFİLLERİ
- ❖ SOĞUTUCU ve LED PROFİLLERİ
- ❖ MOBİLYA ve SANAYİ PROFİLLERİ
- ❖ ÖZEL KALIP ÇİZİMLERİ ve İMALATI
- ❖ ELOKSALLI ve PRES PLAKA LEVHALARI
- ❖ GOFRAJLI ve DÜZ PARLAK RULO LEVHALARI
- ❖ LEVHA KESİM - BÜKÜM (ÖZEL ÖLÇÜLERİNİZDE)
- ❖ DELİKLİ ve DEKORATİF TELLER
- ❖ PLEXI - FOLYO - DEKOTE - POLYCARBON - KOMPOZİT VB.

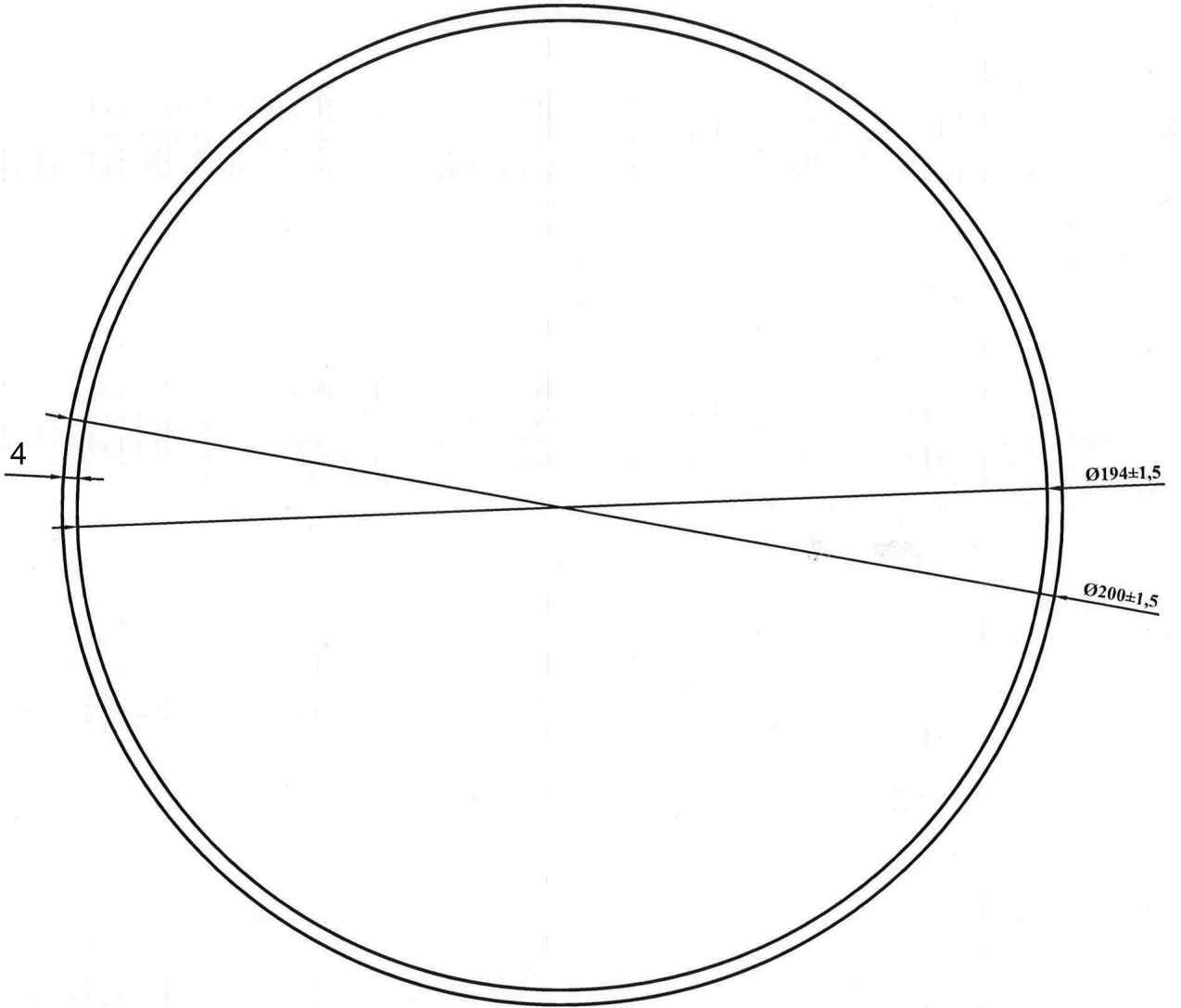

OSM1809
6.80 KG.



OSMANLI
ALÜMİNYUM SAN. ve TİC. LTD .ŞTİ.

- ❖ ÖZEL EBATLARDA BORU, KUTU, LAMA, KÖŞEBENT ÇEŞİTLERİ
- ❖ AYDINLATMA ve REKLAM PROFİLLERİ
- ❖ SOĞUTUCU ve LED PROFİLLERİ
- ❖ MOBİLYA ve SANAYİ PROFİLLERİ
- ❖ ÖZEL KALIP ÇİZİMLERİ ve İMALATI
- ❖ ELOKSALLI ve PRES PLAKA LEVHALARI
- ❖ GOFRAJLI ve DÜZ PARLAK RULO LEVHALARI
- ❖ LEVHA KESİM - BÜKÜM (ÖZEL ÖLÇÜLERİNİZDE)
- ❖ DELİKLİ ve DEKORATİF TELLER
- ❖ PLEXI - FOLYO - DEKOTE - POLYCARBON - KOMPOZİT VB.

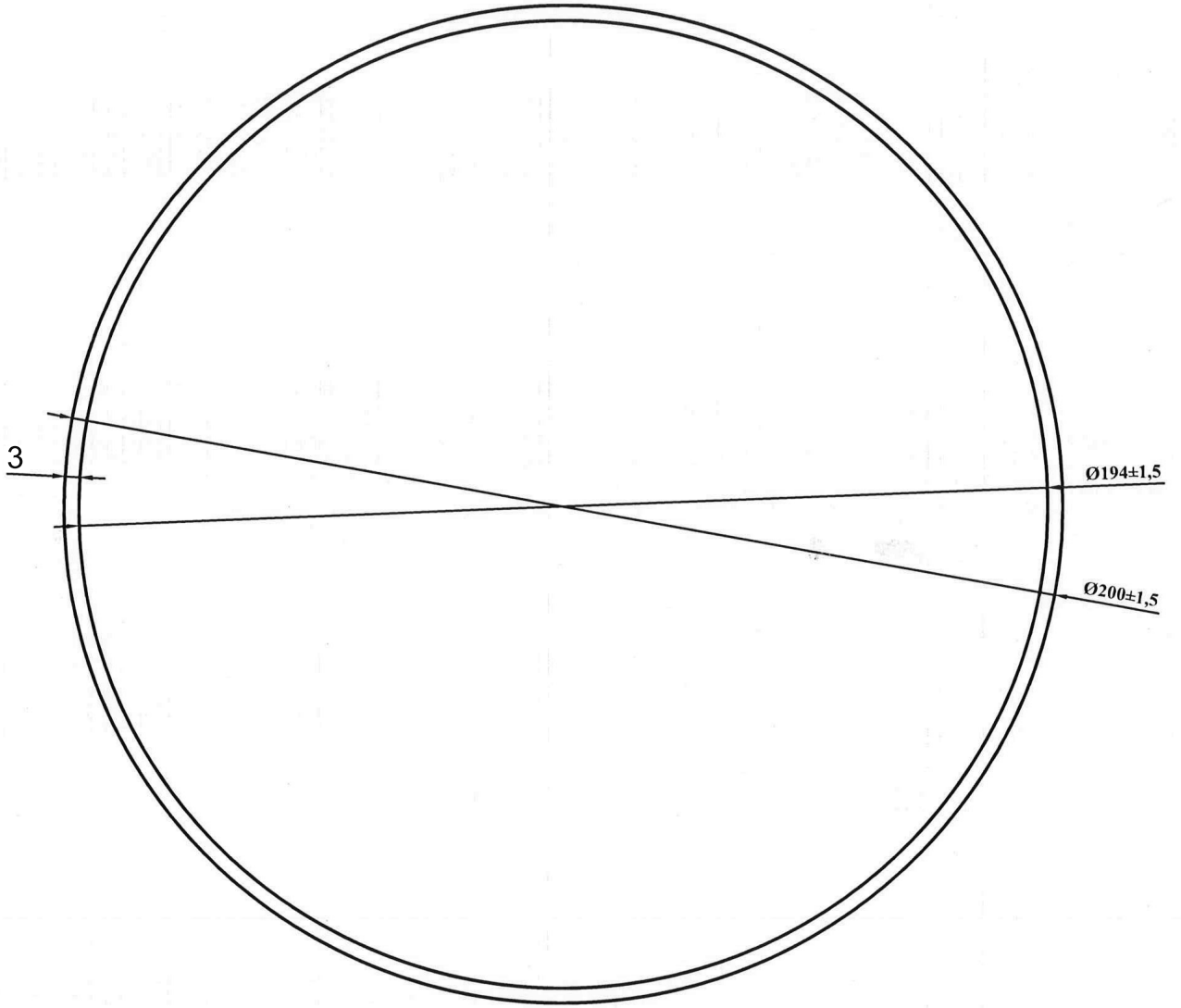

OSM13634
5.10 KG.



OSMANLI
ALÜMİNYUM SAN. ve TİC. LTD .ŞTİ.

- ❖ ÖZEL EBATLARDA BORU, KUTU, LAMA, KÖŞEBENT ÇEŞİTLERİ
- ❖ AYDINLATMA ve REKLAM PROFİLLERİ
- ❖ SOĞUTUCU ve LED PROFİLLERİ
- ❖ MOBİLYA ve SANAYİ PROFİLLERİ
- ❖ ÖZEL KALIP ÇİZİMLERİ ve İMALATI
- ❖ ELOKSALLI ve PRES PLAKA LEVHALARI
- ❖ GOFRAJLI ve DÜZ PARLAK RULO LEVHALARI
- ❖ LEVHA KESİM - BÜKÜM (ÖZEL ÖLÇÜLERİNİZDE)
- ❖ DELİKLİ ve DEKORATİF TELLER
- ❖ PLEXI - FOLYO - DEKOTE - POLYCARBON - KOMPOZİT VB.

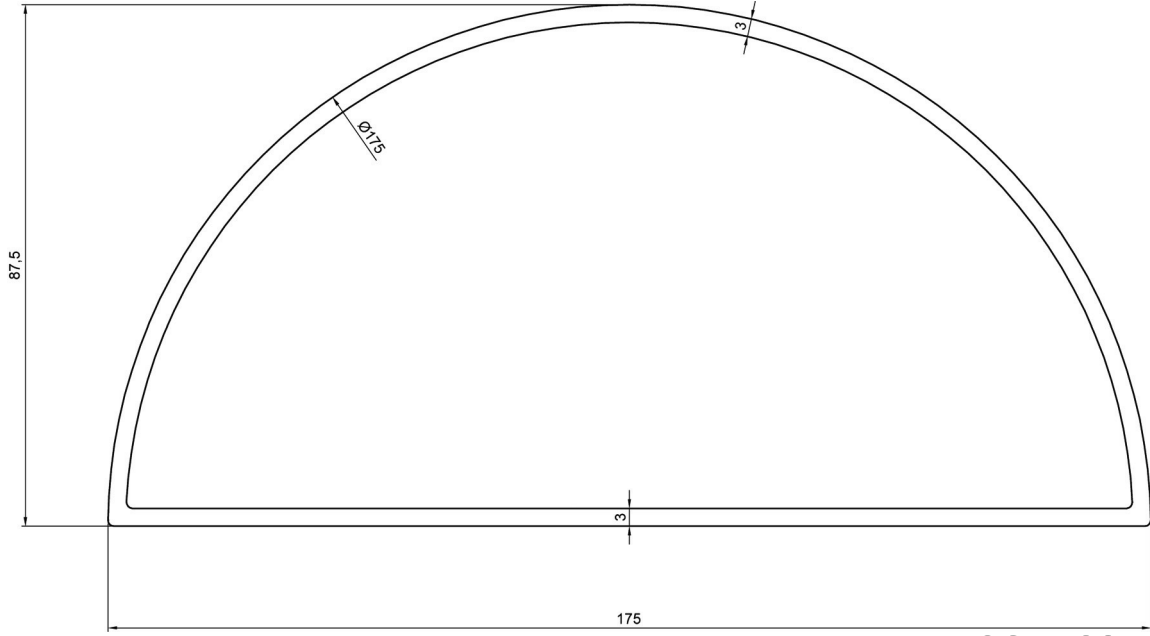

OSM6394
3.60 KG.

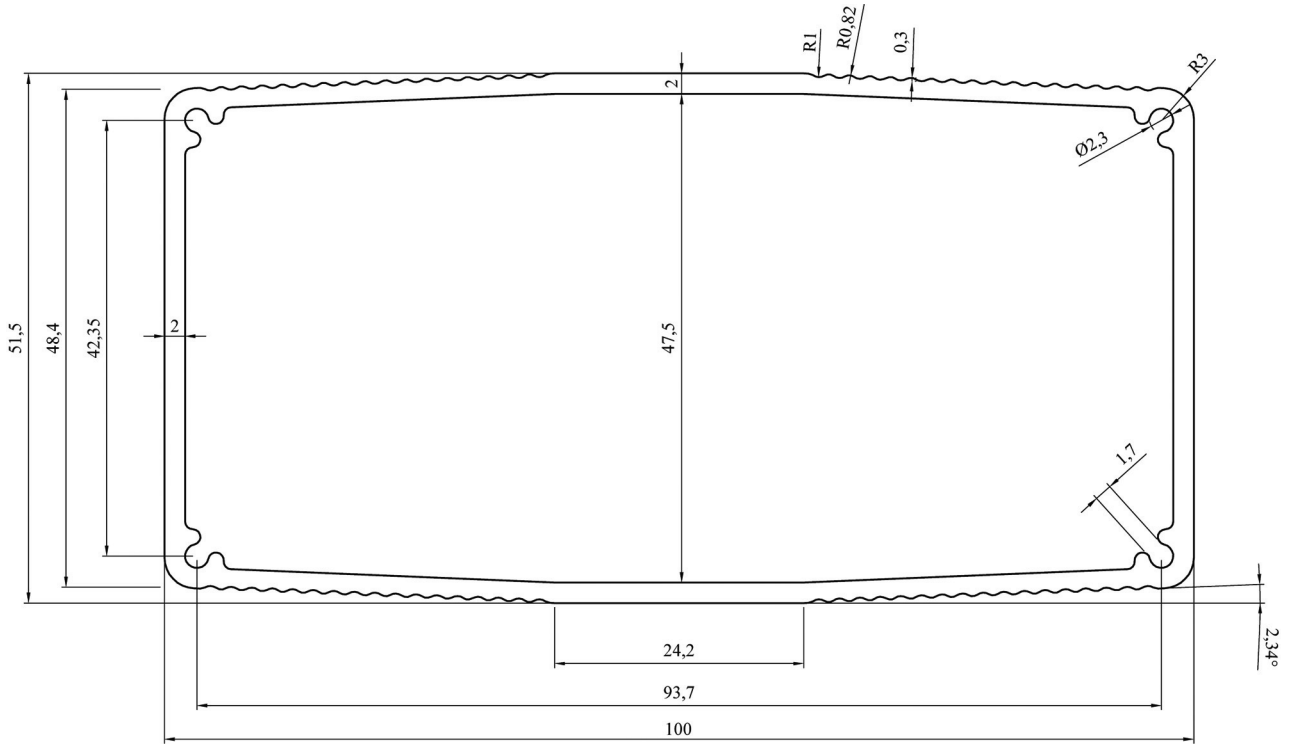

OSM6468
1.60 KG.



OSMANLI
ALÜMİNYUM SAN. ve TİC. LTD .ŞTİ.

- ❖ ÖZEL EBATLARDA BORU, KUTU, LAMA, KÖŞEBENT ÇEŞİTLERİ
- ❖ AYDINLATMA ve REKLAM PROFİLLERİ
- ❖ SOĞUTUCU ve LED PROFİLLERİ
- ❖ MOBİLYA ve SANAYİ PROFİLLERİ
- ❖ ÖZEL KALIP ÇİZİMLERİ ve İMALATI
- ❖ ELOKSALLI ve PRES PLAKA LEVHALARI
- ❖ GOFRAJLI ve DÜZ PARLAK RULO LEVHALARI
- ❖ LEVHA KESİM - BÜKÜM (ÖZEL ÖLÇÜLERİNİZDE)
- ❖ DELİKLİ ve DEKORATİF TELLER
- ❖ PLEXI - FOLYO - DEKOTE - POLYCARBON - KOMPOZİT VB.

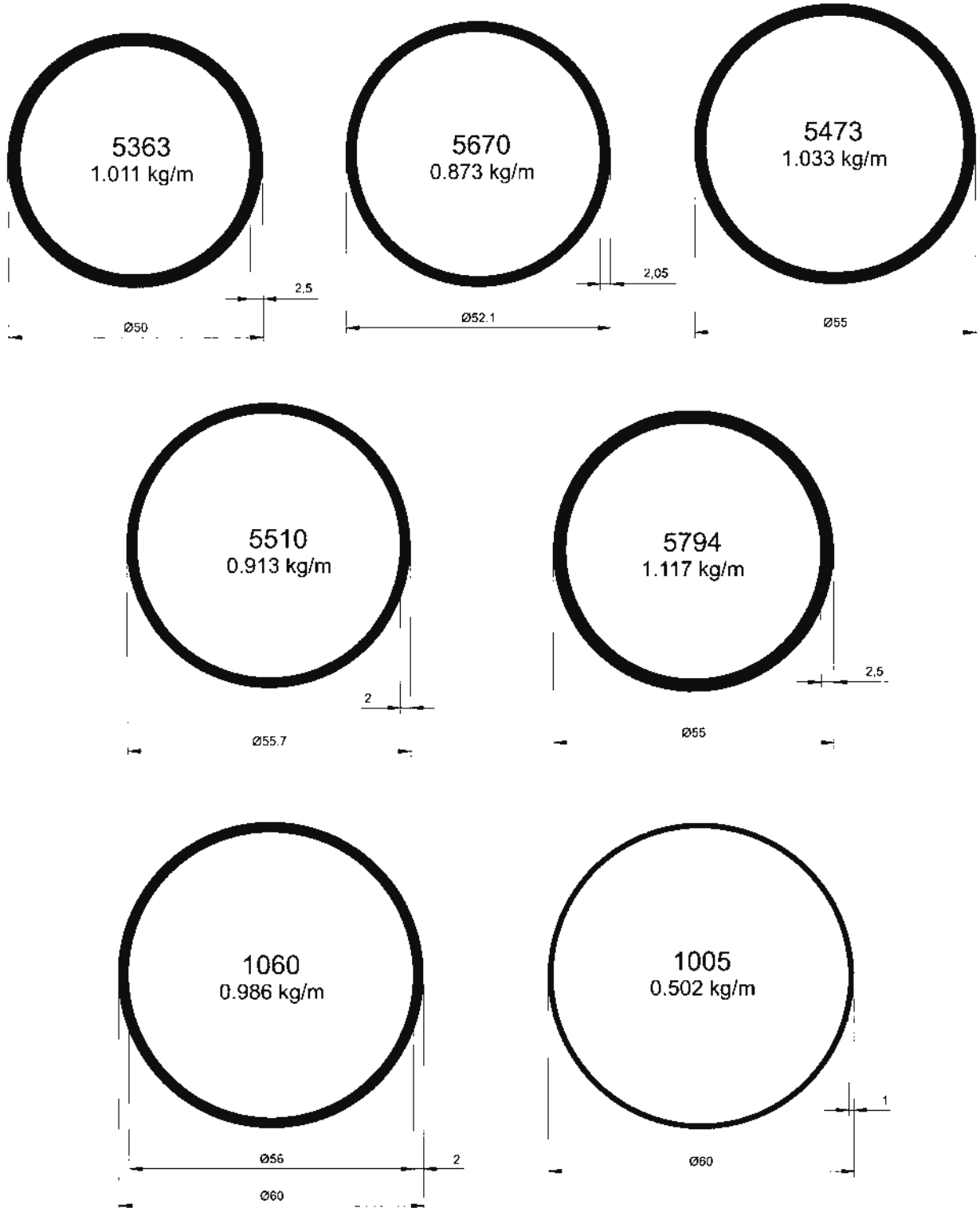



OSMANLI
ALÜMİNYUM SAN. ve TİC. LTD .ŞTİ.

- ❖ ÖZEL EBATLARDA BORU, KUTU, LAMA, KÖŞEBENT ÇEŞİTLERİ
- ❖ AYDINLATMA ve REKLAM PROFİLLERİ
- ❖ SOĞUTUCU ve LED PROFİLLERİ
- ❖ MOBİLYA ve SANAYİ PROFİLLERİ
- ❖ ÖZEL KALIP ÇİZİMLERİ ve İMALATI
- ❖ ELOKSALLI ve PRES PLAKA LEVHALARI
- ❖ GOFRAJLI ve DÜZ PARLAK RULO LEVHALARI
- ❖ LEVHA KESİM - BÜKÜM (ÖZEL ÖLÇÜLERİNİZDE)
- ❖ DELİKLİ ve DEKORATİF TELLER
- ❖ PLEXI - FOLYO - DEKOTE - POLYCARBON - KOMPOZİT VB.

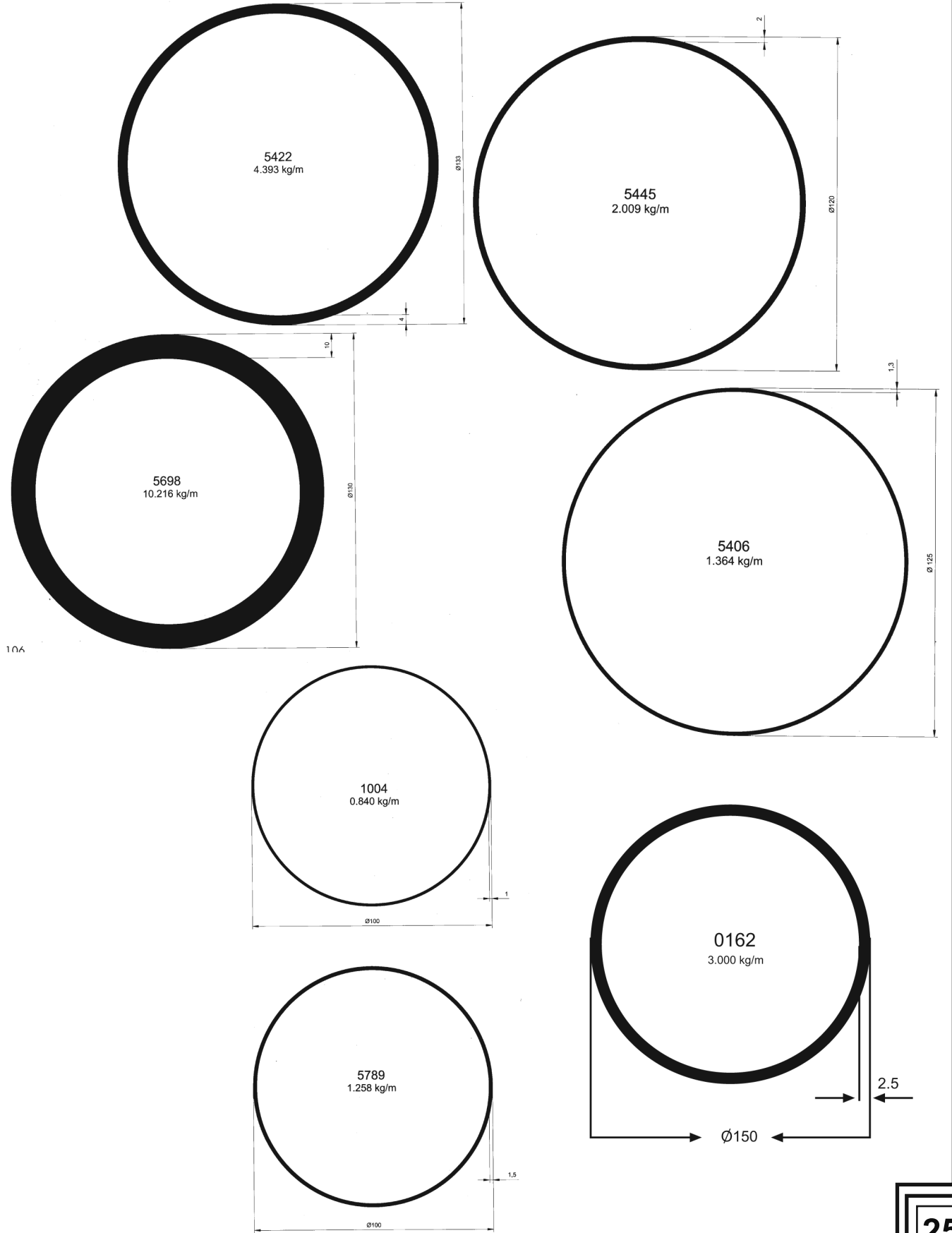



OSMANLI
ALÜMİNYUM SAN. ve TİC. LTD. ŞTİ.

- ❖ ÖZEL EBATLARDA BORU, KUTU, LAMA, KÖŞEBENT ÇEŞİTLERİ
- ❖ AYDINLATMA ve REKLAM PROFİLLERİ
- ❖ SOĞUTUCU ve LED PROFİLLERİ
- ❖ MOBİLYA ve SANAYİ PROFİLLERİ
- ❖ ÖZEL KALIP ÇİZİMLERİ ve İMALATI
- ❖ ELOKSALLI ve PRES PLAKA LEVHALARI
- ❖ GOFRAJLI ve DÜZ PARLAK RULO LEVHALARI
- ❖ LEVHA KESİM - BÜKÜM (ÖZEL ÖLÇÜLERİNİZDE)
- ❖ DELİKLİ ve DEKORATİF TELLER
- ❖ PLEXI - FOLYO - DEKOTE - POLYCARBON - KOMPOZİT VB.

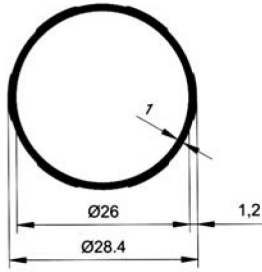

5433
0.252 kg/m

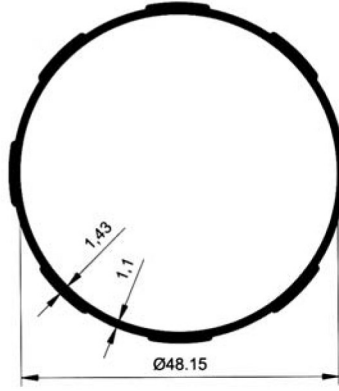

5449
0.531 kg/m

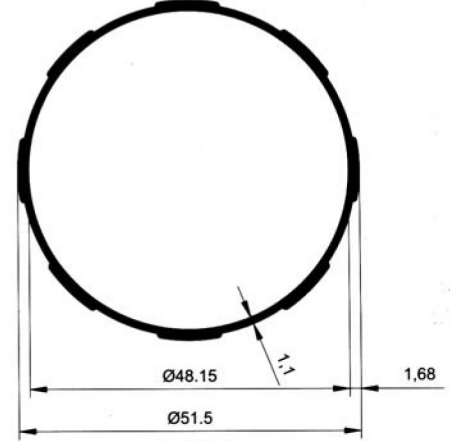

5434
0.580 kg/m

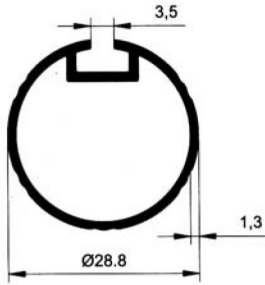

5609
0.349 kg/m

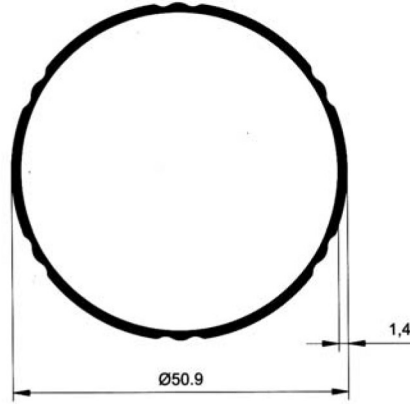

5608
0.556 kg/m

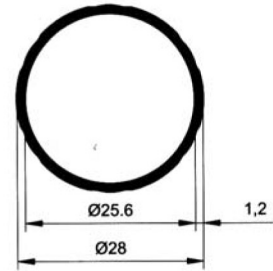

5724
0.262 kg/m

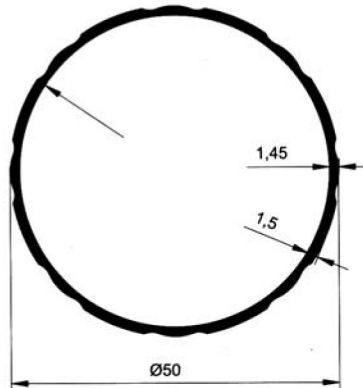

5723
0.567 kg/m



OSMANLI
ALÜMİNYUM SAN. ve TİC. LTD. ŞTİ.

- ❖ ÖZEL EBATLARDA BORU, KUTU, LAMA, KÖŞEBENT ÇEŞİTLERİ
- ❖ AYDINLATMA ve REKLAM PROFİLLERİ
- ❖ SOĞUTUCU ve LED PROFİLLERİ
- ❖ MOBİLYA ve SANAYİ PROFİLLERİ
- ❖ ÖZEL KALIP ÇİZİMLERİ ve İMALATI
- ❖ ELOKSALLI ve PRES PLAKA LEVHALARI
- ❖ GOFRAJLI ve DÜZ PARLAK RULO LEVHALARI
- ❖ LEVHA KESİM - BÜKÜM (ÖZEL ÖLÇÜLERİNİZDE)
- ❖ DELİKLİ ve DEKORATİF TELLER
- ❖ PLEXI - FOLYO - DEKOTE - POLYCARBON - KOMPOZİT VB.

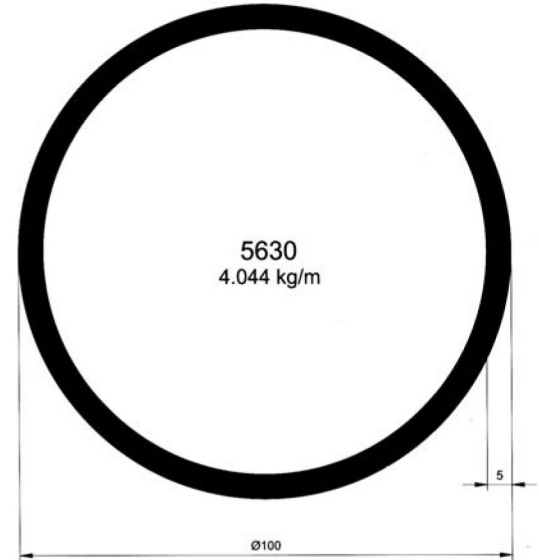
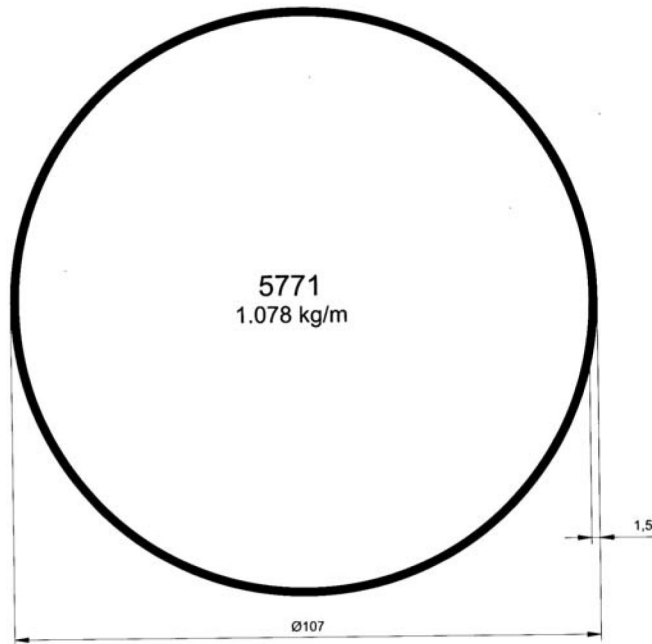
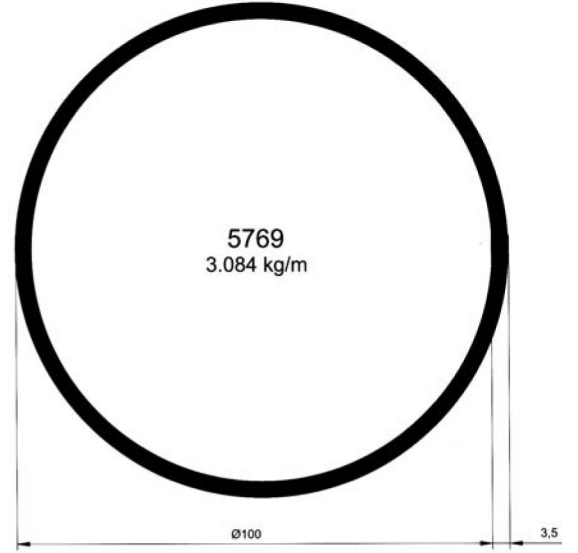
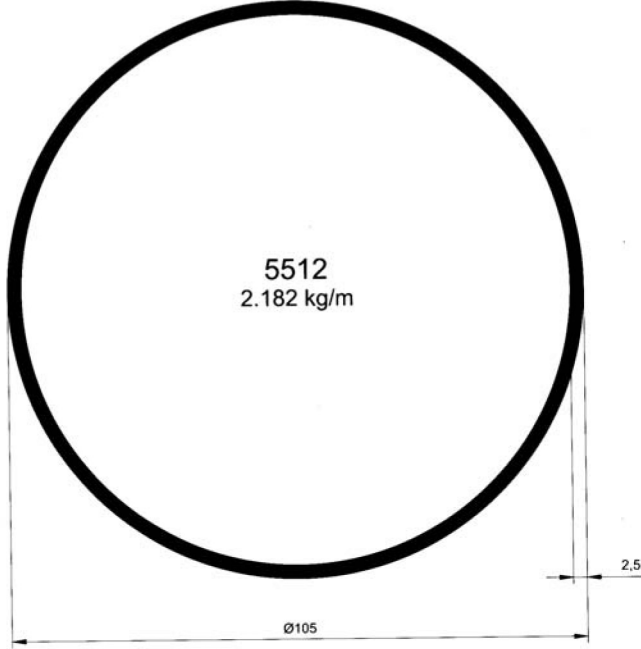



OSMANLI
ALÜMİNYUM SAN. ve TİC. LTD. ŞTİ.

- ❖ ÖZEL EBATLARDA BORU, KUTU, LAMA, KÖŞEBENT ÇEŞİTLERİ
- ❖ AYDINLATMA ve REKLAM PROFİLLERİ
- ❖ SOĞUTUCU ve LED PROFİLLERİ
- ❖ MOBİLYA ve SANAYİ PROFİLLERİ
- ❖ ÖZEL KALIP ÇİZİMLERİ ve İMALATI
- ❖ ELOKSALLI ve PRES PLAKA LEVHALARI
- ❖ GOFRAJLI ve DÜZ PARLAK RULO LEVHALARI
- ❖ LEVHA KESİM - BÜKÜM (ÖZEL ÖLÇÜLERİNİZDE)
- ❖ DELİKLİ ve DEKORATİF TELLER
- ❖ PLEXI - FOLYO - DEKOTE - POLYCARBON - KOMPOZİT VB.

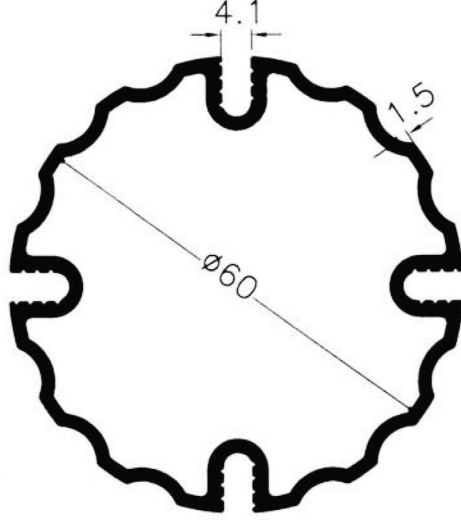

5273
1.030 Kg/m

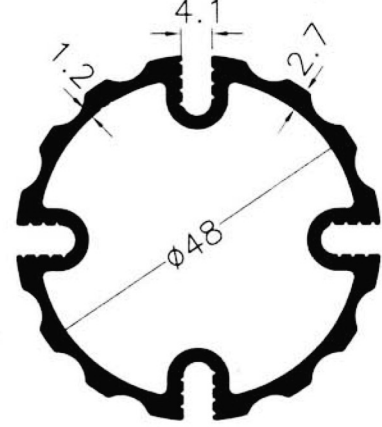

5272
0.983 Kg/m

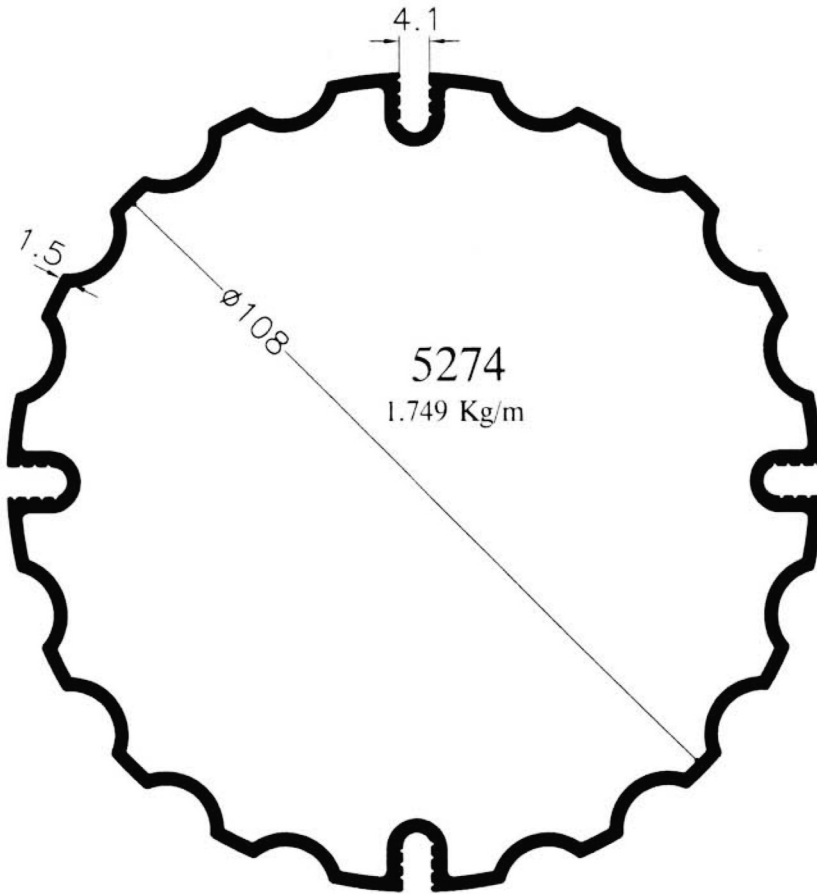

5274
1.749 Kg/m

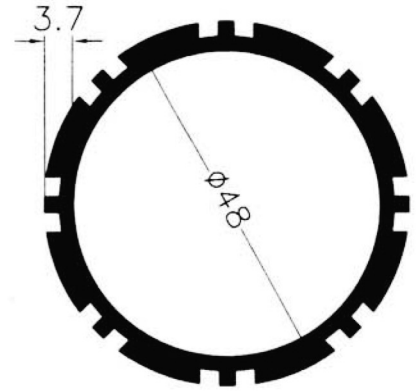

3835
1.147 Kg/m

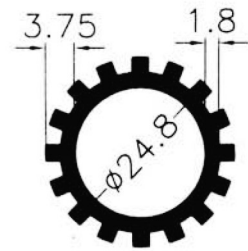

3836
0.460 Kg/m



OSMANLI
ALÜMİNYUM SAN. ve TİC. LTD .ŞTİ.

- ❖ ÖZEL EBATLARDA BORU, KUTU, LAMA, KÖŞEBENT ÇEŞİTLERİ
- ❖ AYDINLATMA ve REKLAM PROFİLLERİ
- ❖ SOĞUTUCU ve LED PROFİLLERİ
- ❖ MOBİLYA ve SANAYİ PROFİLLERİ
- ❖ ÖZEL KALIP ÇİZİMLERİ ve İMALATI
- ❖ ELOKSALLI ve PRES PLAKA LEVHALARI
- ❖ GOFRAJLI ve DÜZ PARLAK RULO LEVHALARI
- ❖ LEVHA KESİM - BÜKÜM (ÖZEL ÖLÇÜLERİNİZDE)
- ❖ DELİKLİ ve DEKORATİF TELLER
- ❖ PLEXI - FOLYO - DEKOTE - POLYCARBON - KOMPOZİT VB.

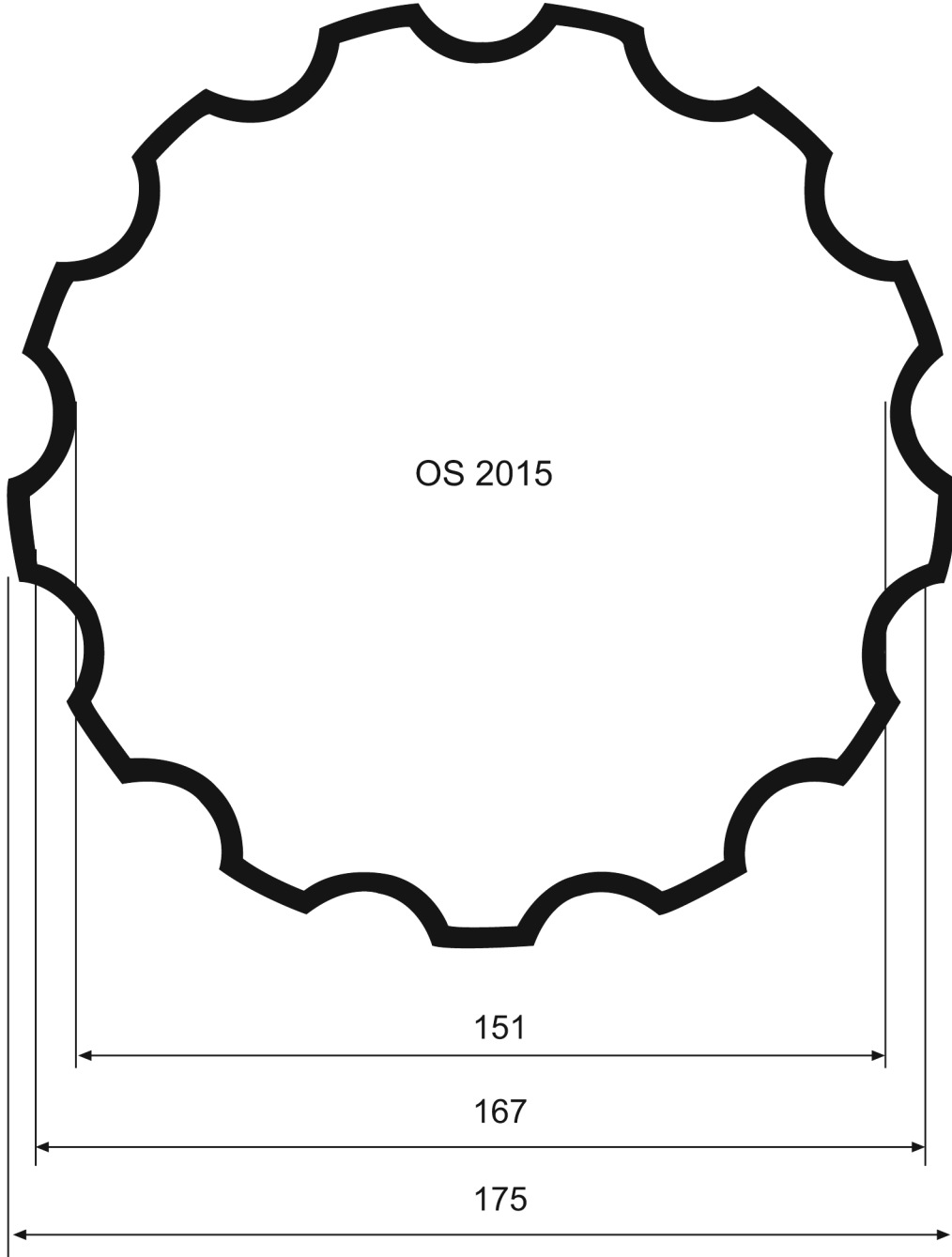



OSMANLI
ALÜMİNYUM SAN. ve TİC. LTD. ŞTİ.

- ❖ ÖZEL EBATLARDA BORU, KUTU, LAMA, KÖŞEBENT ÇEŞİTLERİ
- ❖ AYDINLATMA ve REKLAM PROFİLLERİ
- ❖ SOĞUTUCU ve LED PROFİLLERİ
- ❖ MOBİLYA ve SANAYİ PROFİLLERİ
- ❖ ÖZEL KALIP ÇİZİMLERİ ve İMALATI
- ❖ ELOKSALLI ve PRES PLAKA LEVHALARI
- ❖ GOFRAJLI ve DÜZ PARLAK RULO LEVHALARI
- ❖ LEVHA KESİM - BÜKÜM (ÖZEL ÖLÇÜLERİNİZDE)
- ❖ DELİKLİ ve DEKORATİF TELLER
- ❖ PLEXI - FOLYO - DEKOTE - POLYCARBON - KOMPOZİT VB.

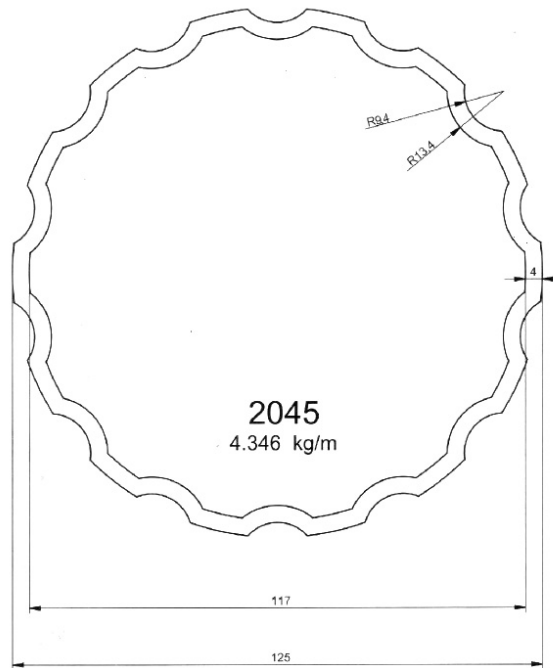
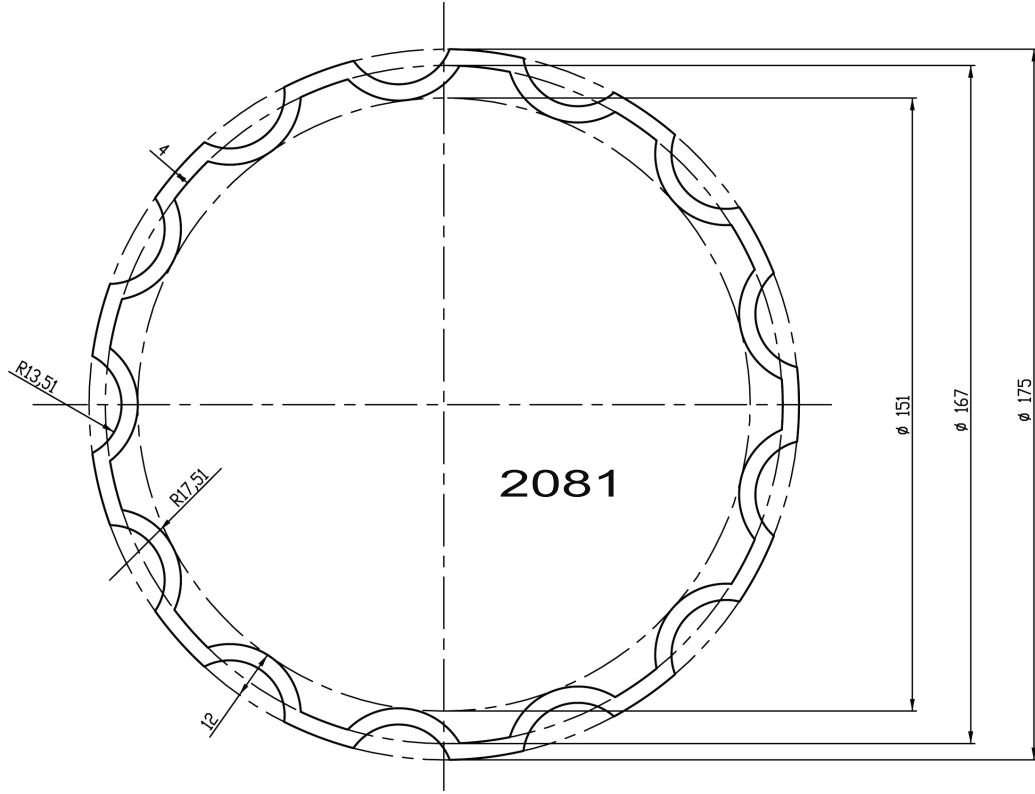



OSMANLI
ALÜMİNYUM SAN. ve TİC. LTD .ŞTİ.

- ❖ ÖZEL EBATLARDA BORU, KUTU, LAMA, KÖŞEBENT ÇEŞİTLERİ
- ❖ AYDINLATMA ve REKLAM PROFİLLERİ
- ❖ SOĞUTUCU ve LED PROFİLLERİ
- ❖ MOBİLYA ve SANAYİ PROFİLLERİ
- ❖ ÖZEL KALIP ÇİZİMLERİ ve İMALATI
- ❖ ELOKSALLI ve PRES PLAKA LEVHALARI
- ❖ GOFRAJLI ve DÜZ PARLAK RULO LEVHALARI
- ❖ LEVHA KESİM - BÜKÜM (ÖZEL ÖLÇÜLERİNİZDE)
- ❖ DELİKLİ ve DEKORATİF TELLER
- ❖ PLEXI - FOLYO - DEKOTE - POLYCARBON - KOMPOZİT VB.

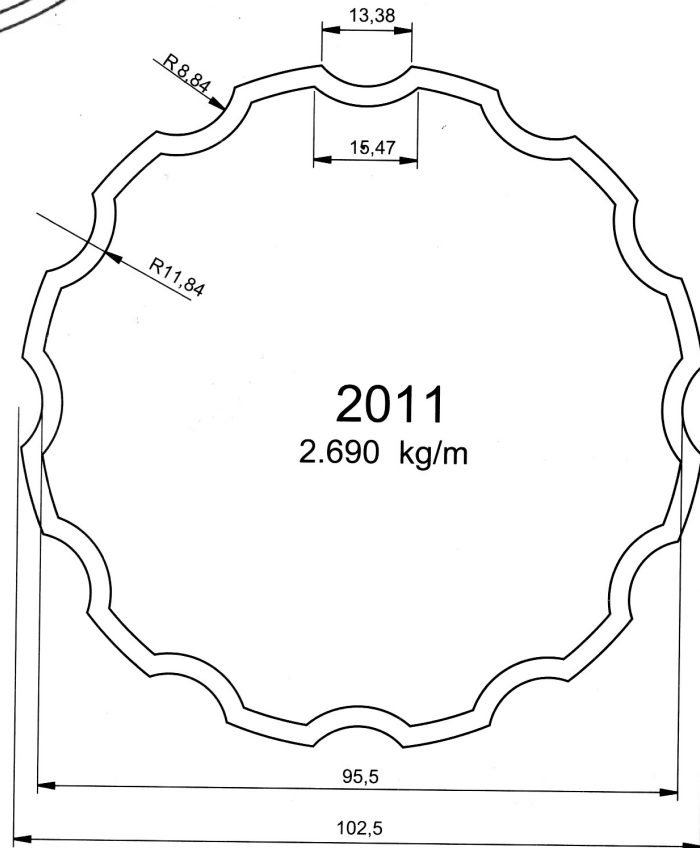
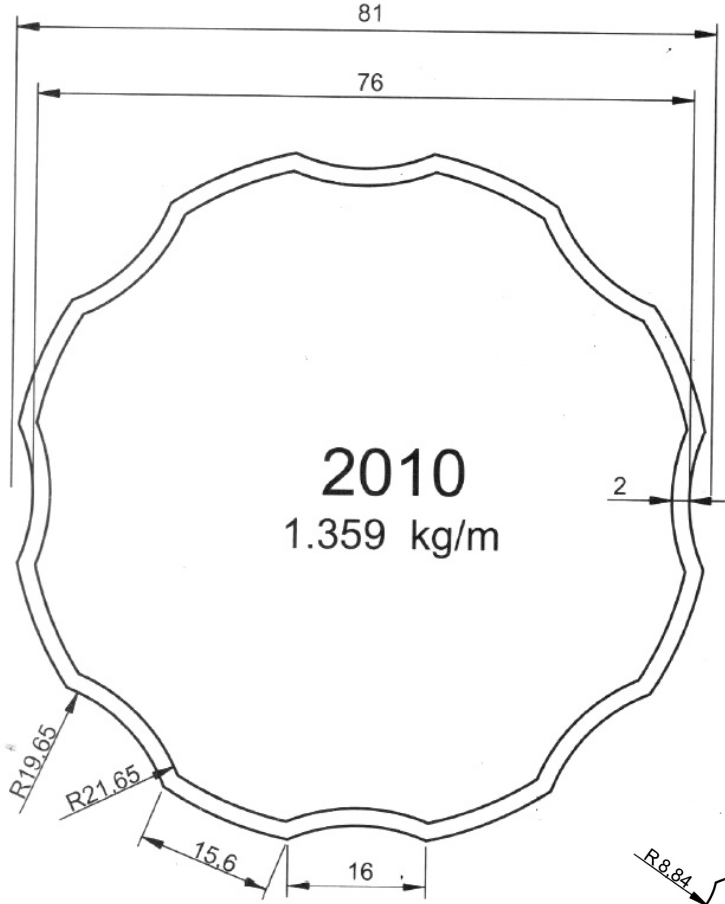



OSMANLI
ALÜMİNYUM SAN. ve TİC. LTD .ŞTİ.

- ❖ ÖZEL EBATLARDA BORU, KUTU, LAMA, KÖŞEBENT ÇEŞİTLERİ
- ❖ AYDINLATMA ve REKLAM PROFİLLERİ
- ❖ SOĞUTUCU ve LED PROFİLLERİ
- ❖ MOBİLYA ve SANAYİ PROFİLLERİ
- ❖ ÖZEL KALIP ÇİZİMLERİ ve İMALATI
- ❖ ELOKSALLI ve PRES PLAKA LEVHALARI
- ❖ GOFRAJLI ve DÜZ PARLAK RULO LEVHALARI
- ❖ LEVHA KESİM - BÜKÜM (ÖZEL ÖLÇÜLERİNİZDE)
- ❖ DELİKLİ ve DEKORATİF TELLER
- ❖ PLEXI - FOLYO - DEKOTE - POLYCARBON - KOMPOZİT VB.

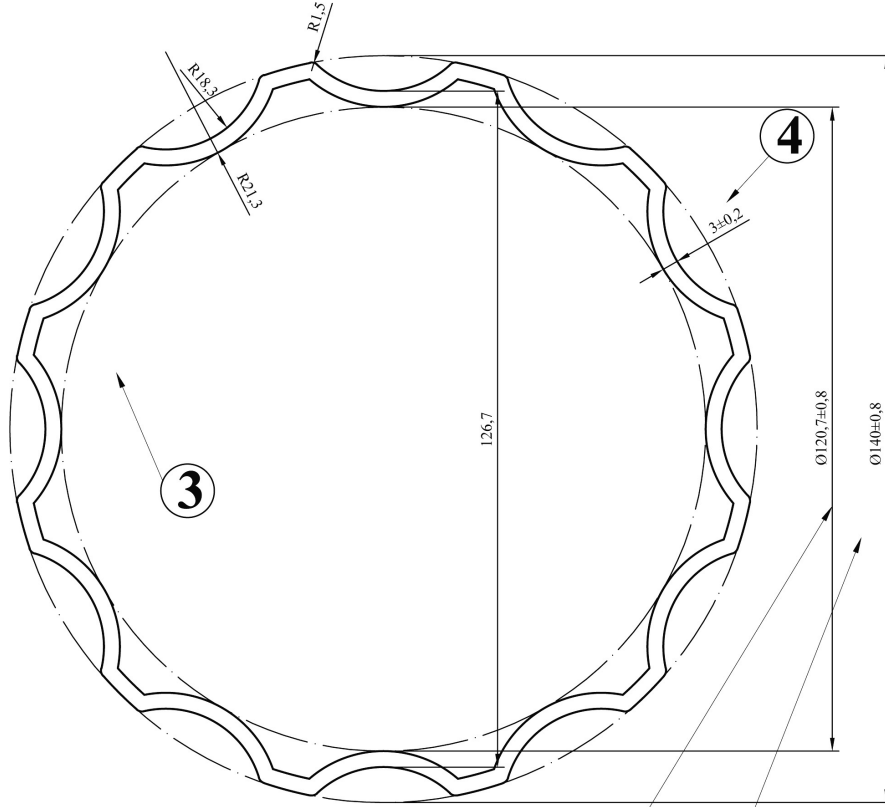

OSM7230

2

1

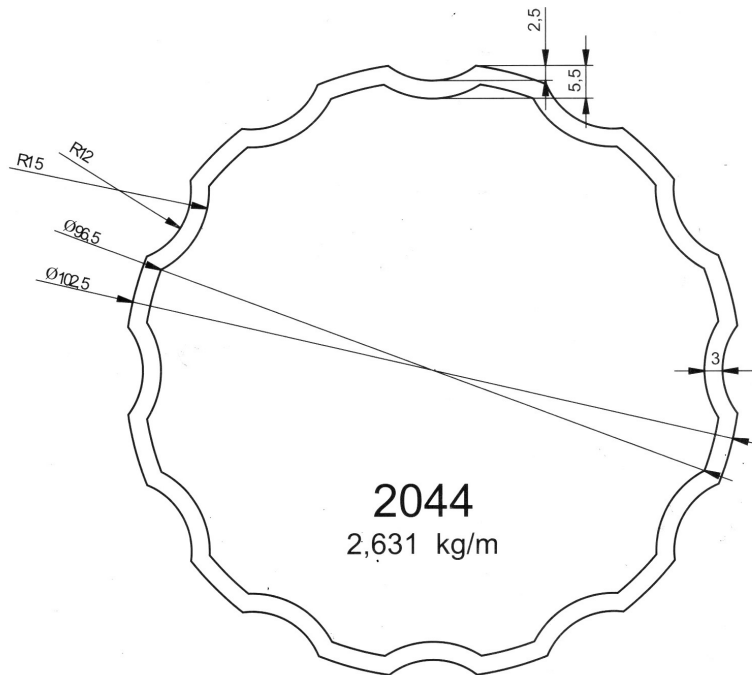

2044
2,631 kg/m



OSMANLI
ALÜMİNYUM SAN. ve TİC. LTD .ŞTİ.

- ❖ ÖZEL EBATLARDA BORU, KUTU, LAMA, KÖŞEBENT ÇEŞİTLERİ
- ❖ AYDINLATMA ve REKLAM PROFİLLERİ
- ❖ SOĞUTUCU ve LED PROFİLLERİ
- ❖ MOBİLYA ve SANAYİ PROFİLLERİ
- ❖ ÖZEL KALIP ÇİZİMLERİ ve İMALATI
- ❖ ELOKSALLI ve PRES PLAKA LEVHALARI
- ❖ GOFRAJLI ve DÜZ PARLAK RULO LEVHALARI
- ❖ LEVHA KESİM - BÜKÜM (ÖZEL ÖLÇÜLERİNİZDE)
- ❖ DELİKLİ ve DEKORATİF TELLER
- ❖ PLEXI - FOLYO - DEKOTE - POLYCARBON - KOMPOZİT VB.

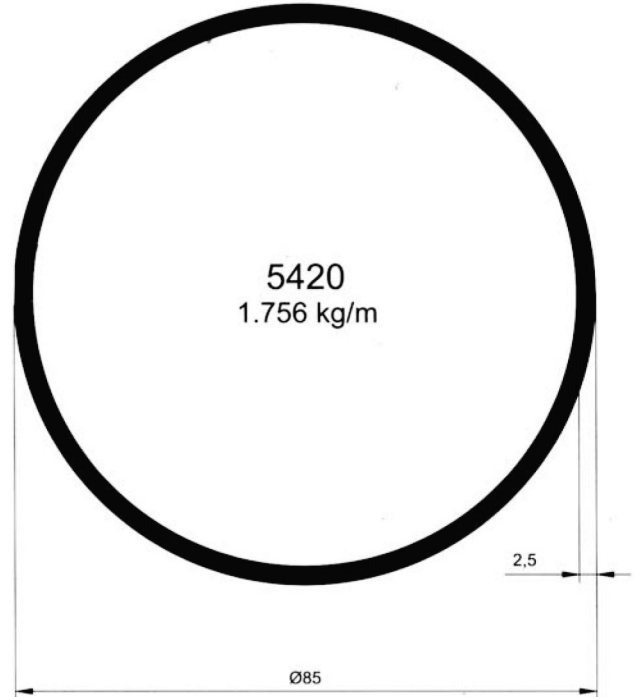
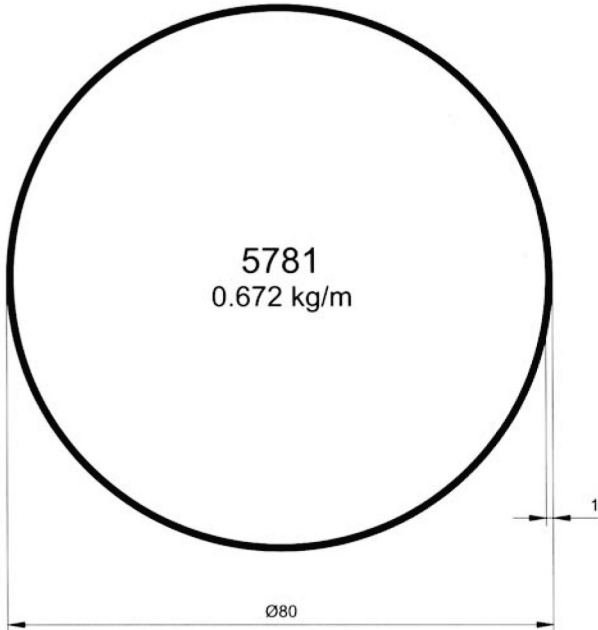
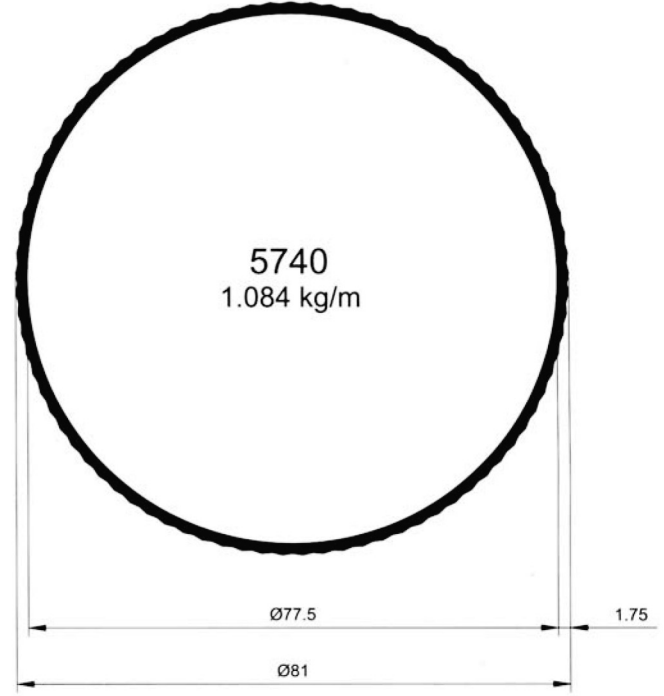
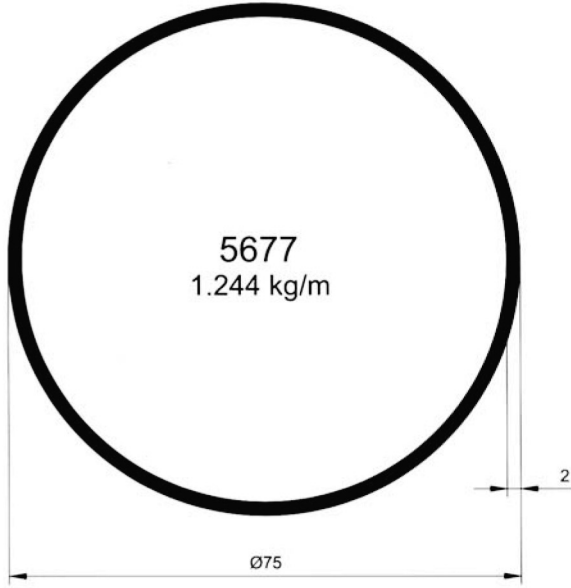



OSMANLI
ALÜMİNYUM SAN. ve TİC. LTD. ŞTİ.

- ❖ ÖZEL EBATLARDA BORU, KUTU, LAMA, KÖŞEBENT ÇEŞİTLERİ
- ❖ AYDINLATMA ve REKLAM PROFİLLERİ
- ❖ SOĞUTUCU ve LED PROFİLLERİ
- ❖ MOBİLYA ve SANAYİ PROFİLLERİ
- ❖ ÖZEL KALIP ÇİZİMLERİ ve İMALATI
- ❖ ELOKSALLI ve PRES PLAKA LEVHALARI
- ❖ GOFRAJLI ve DÜZ PARLAK RULO LEVHALARI
- ❖ LEVHA KESİM - BÜKÜM (ÖZEL ÖLÇÜLERİNİZDE)
- ❖ DELİKLİ ve DEKORATİF TELLER
- ❖ PLEXI - FOLYO - DEKOTE - POLYCARBON - KOMPOZİT VB.

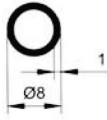

5571
0.059 kg/m

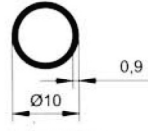

5493
0.070 kg/m

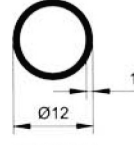

5577
0.095 kg/m

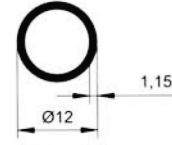

5455
0.106 kg/m

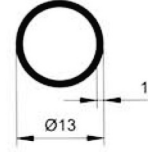

5533
0.102 kg/m

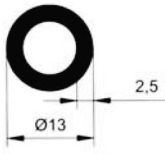

5355
0.221 kg/m

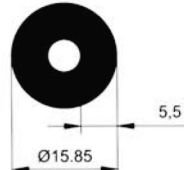

5370
0.484 kg/m

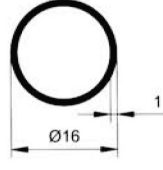

5568
0.127 kg/m

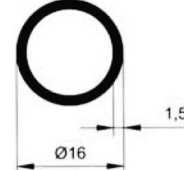

5365
0.185 kg/m

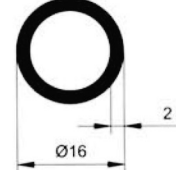

1054
0.238 kg/m

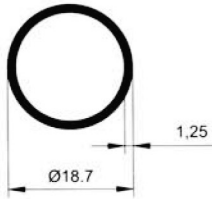

5364
0.185 kg/m

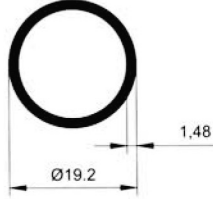

5472
0.222 kg/m

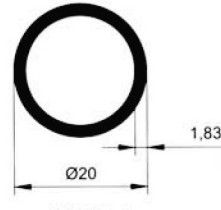

5674
0.282 kg/m

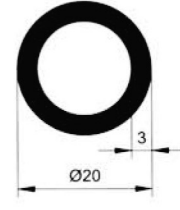

5409
0.434 kg/m

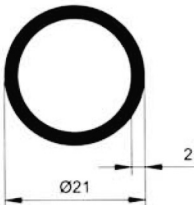

1055
0.321 kg/m

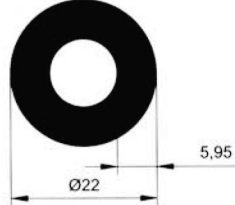

5726
0.813 kg/m

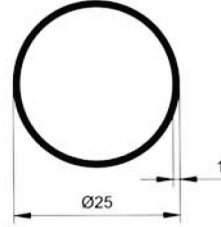

1050
0.204 kg/m

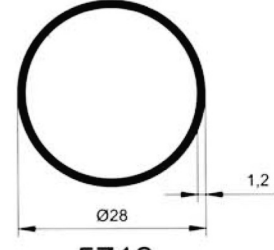

5712
0.274 kg/m

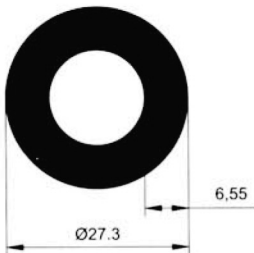

5672
1.157 kg/m

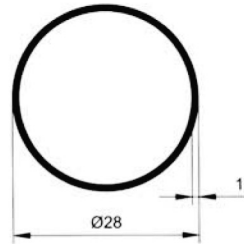

5669
0.229 kg/m

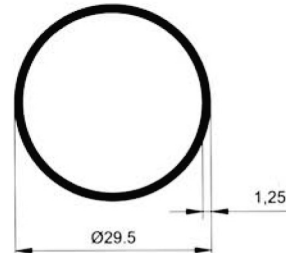

5558
0.301 kg/m

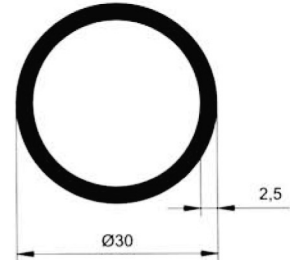

5552
0.585 kg/m



OSMANLI
ALÜMİNYUM SAN. ve TİC. LTD .ŞTİ.

- ❖ ÖZEL EBATLARDA BORU, KUTU, LAMA, KÖŞEBENT ÇEŞİTLERİ
- ❖ AYDINLATMA ve REKLAM PROFİLLERİ
- ❖ SOĞUTUCU ve LED PROFİLLERİ
- ❖ MOBİLYA ve SANAYİ PROFİLLERİ
- ❖ ÖZEL KALIP ÇİZİMLERİ ve İMALATI
- ❖ ELOKSALLI ve PRES PLAKA LEVHALARI
- ❖ GOFRAJLI ve DÜZ PARLAK RULO LEVHALARI
- ❖ LEVHA KESİM - BÜKÜM (ÖZEL ÖLÇÜLERİNİZDE)
- ❖ DELİKLİ ve DEKORATİF TELLER
- ❖ PLEXI - FOLYO - DEKOTE - POLYCARBON - KOMPOZİT VB.

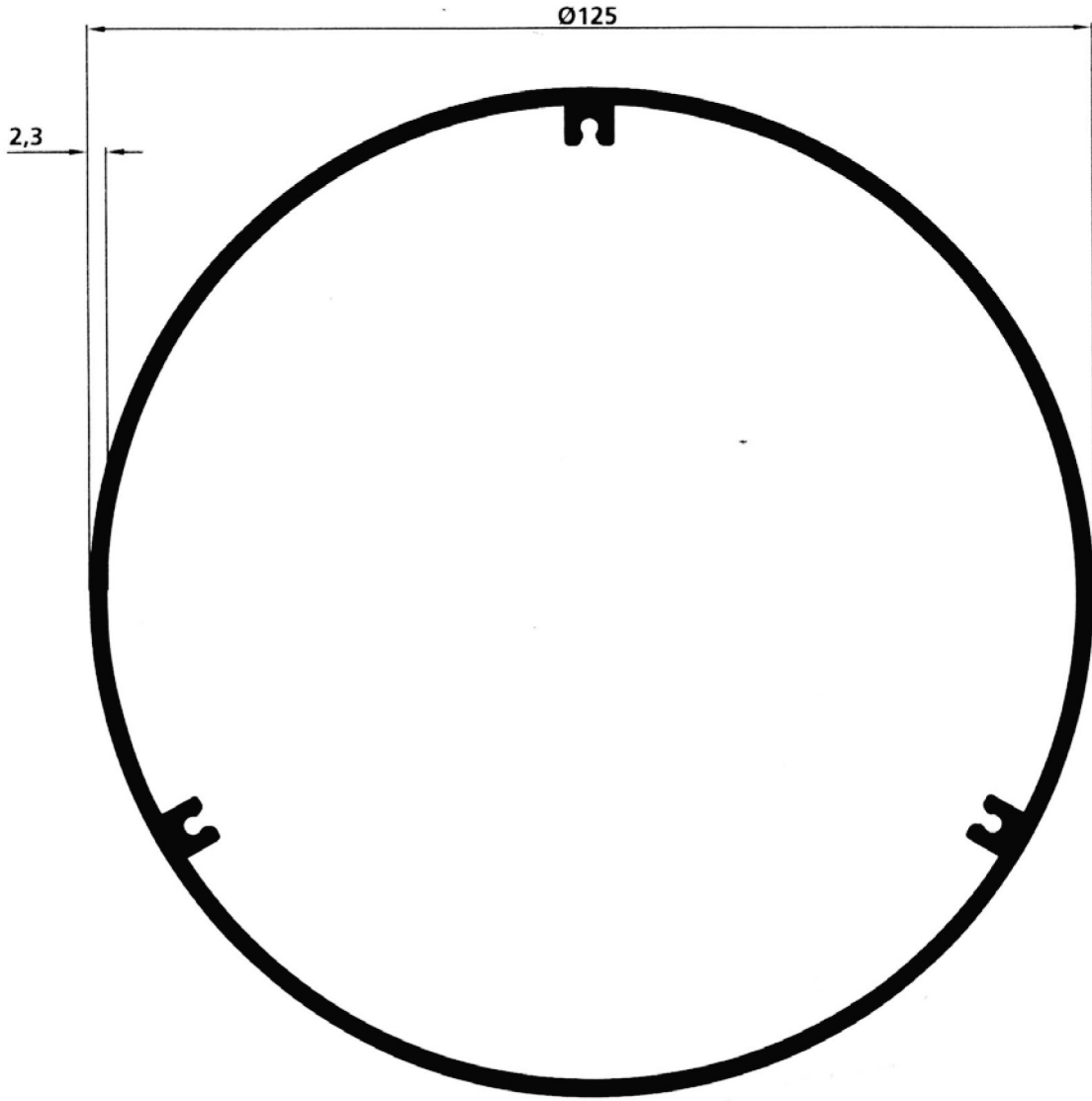

11536 2,583 kg/m



OSMANLI
ALÜMİNYUM SAN. ve TİC. LTD. ŞTİ.

- ❖ ÖZEL EBATLARDA BORU, KUTU, LAMA, KÖŞEBENT ÇEŞİTLERİ
- ❖ AYDINLATMA ve REKLAM PROFİLLERİ
- ❖ SOĞUTUCU ve LED PROFİLLERİ
- ❖ MOBİLYA ve SANAYİ PROFİLLERİ
- ❖ ÖZEL KALIP ÇİZİMLERİ ve İMALATI
- ❖ ELOKSALLI ve PRES PLAKA LEVHALARI
- ❖ GOFRAJLI ve DÜZ PARLAK RULO LEVHALARI
- ❖ LEVHA KESİM - BÜKÜM (ÖZEL ÖLÇÜLERİNİZDE)
- ❖ DELİKLİ ve DEKORATİF TELLER
- ❖ PLEXI - FOLYO - DEKOTE - POLYCARBON - KOMPOZİT VB.

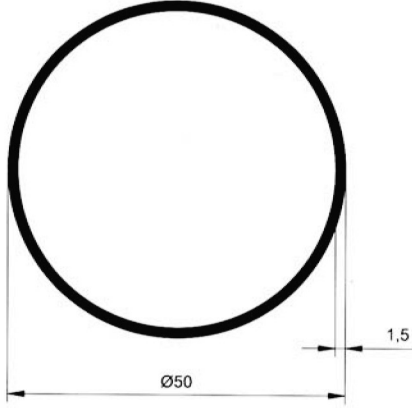

5361
0.619 kg/m

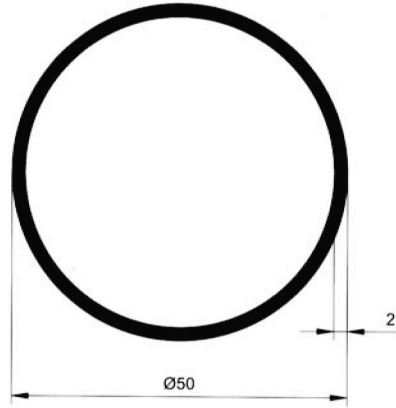

5362
0.817 kg/m

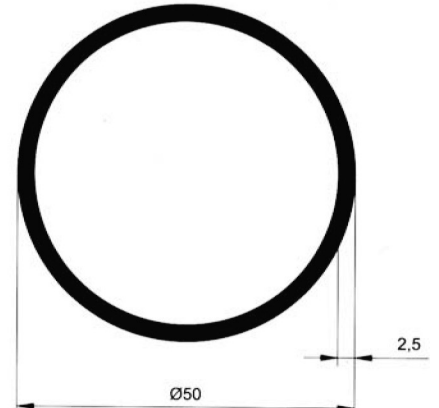

5363
1.011 kg/m

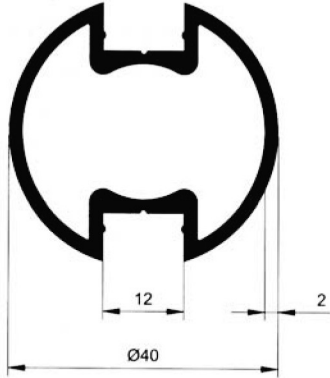

5366
0.845 kg/m

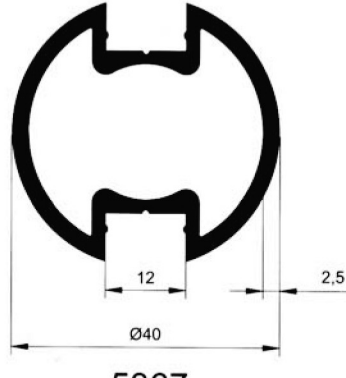

5367
0.951 kg/m

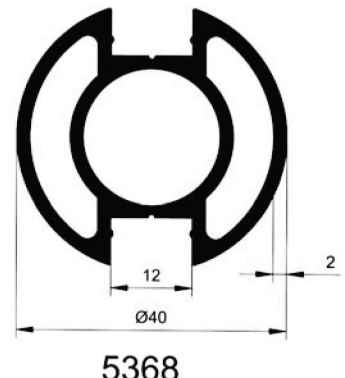

5368
1.084 kg/m

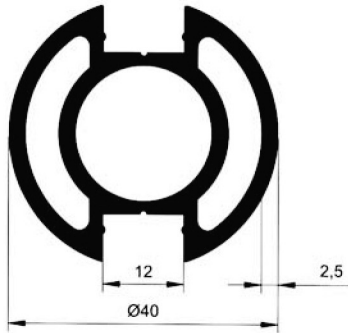

5369
1.249 kg/m

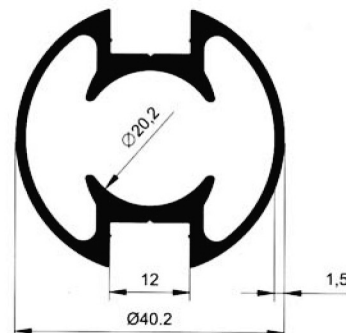

5638
0.883 kg/m

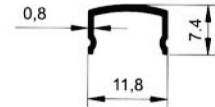

5372
0.059 kg/m



OSMANLI
ALÜMİNYUM SAN. ve TİC. LTD. ŞTİ.

- ❖ ÖZEL EBATLARDA BORU, KUTU, LAMA, KÖŞEBENT ÇEŞİTLERİ
- ❖ AYDINLATMA ve REKLAM PROFİLLERİ
- ❖ SOĞUTUCU ve LED PROFİLLERİ
- ❖ MOBİLYA ve SANAYİ PROFİLLERİ
- ❖ ÖZEL KALIP ÇİZİMLERİ ve İMALATI
- ❖ ELOKSALLI ve PRES PLAKA LEVHALARI
- ❖ GOFRAJLI ve DÜZ PARLAK RULO LEVHALARI
- ❖ LEVHA KESİM - BÜKÜM (ÖZEL ÖLÇÜLERİNİZDE)
- ❖ DELİKLİ ve DEKORATİF TELLER
- ❖ PLEXI - FOLYO - DEKOTE - POLYCARBON - KOMPOZİT VB.

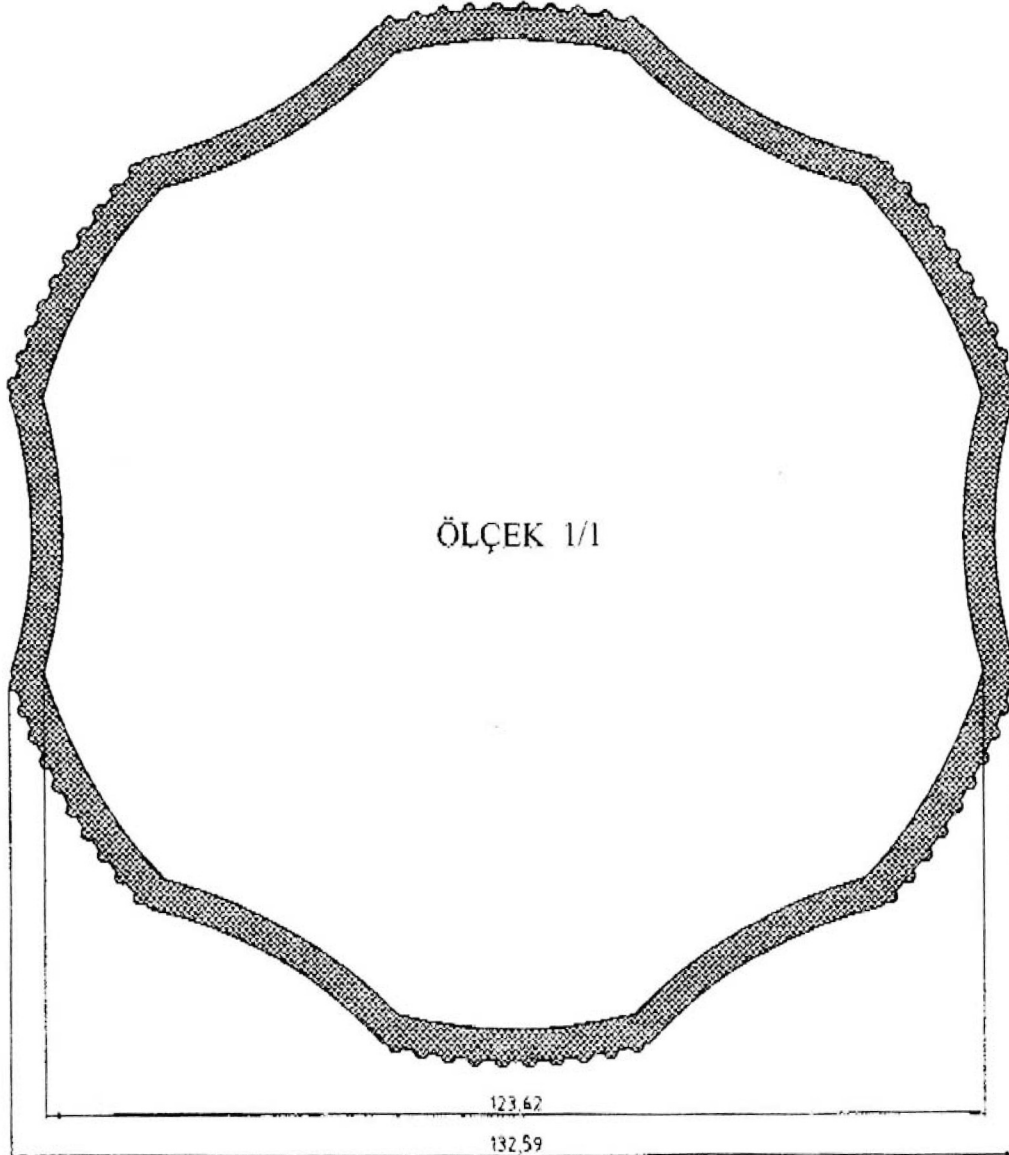
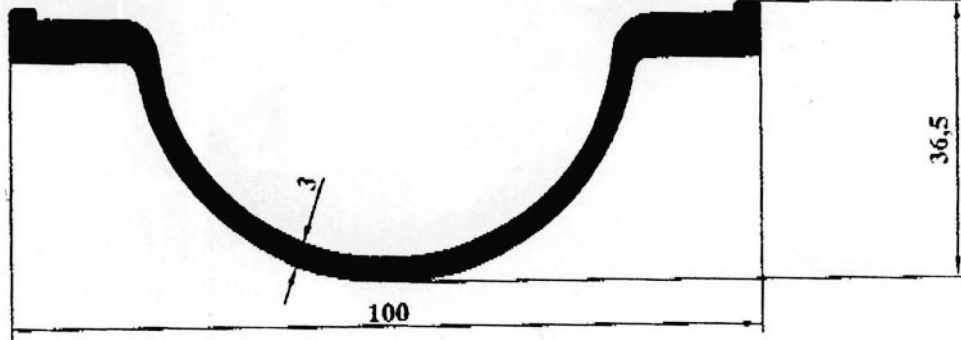



OSMANLI
ALÜMİNYUM SAN. ve TİC. LTD .ŞTİ.

- ❖ ÖZEL EBATLARDA BORU, KUTU, LAMA, KÖŞEBENT ÇEŞİTLERİ
- ❖ AYDINLATMA ve REKLAM PROFİLLERİ
- ❖ SOĞUTUCU ve LED PROFİLLERİ
- ❖ MOBİLYA ve SANAYİ PROFİLLERİ
- ❖ ÖZEL KALIP ÇİZİMLERİ ve İMALATI
- ❖ ELOKSALLI ve PRES PLAKA LEVHALARI
- ❖ GOFRAJLI ve DÜZ PARLAK RULO LEVHALARI
- ❖ LEVHA KESİM - BÜKÜM (ÖZEL ÖLÇÜLERİNİZDE)
- ❖ DELİKLİ ve DEKORATİF TELLER
- ❖ PLEXI - FOLYO - DEKOTE - POLYCARBON - KOMPOZİT VB.

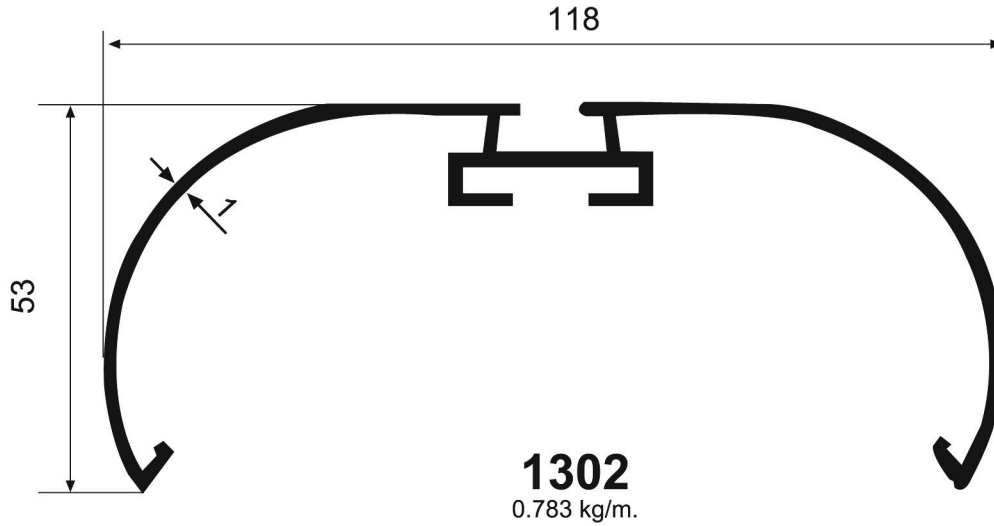
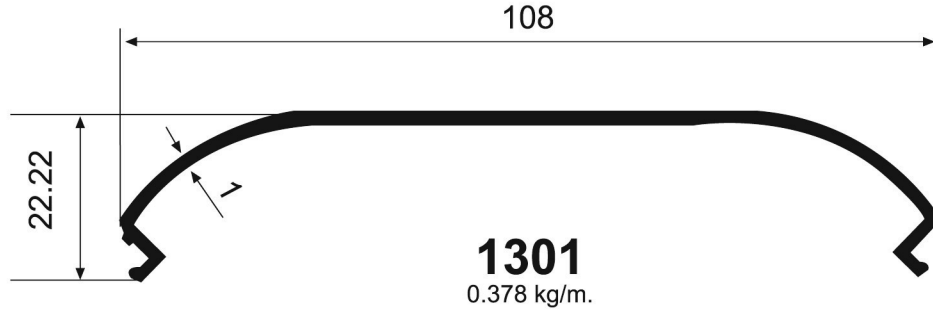
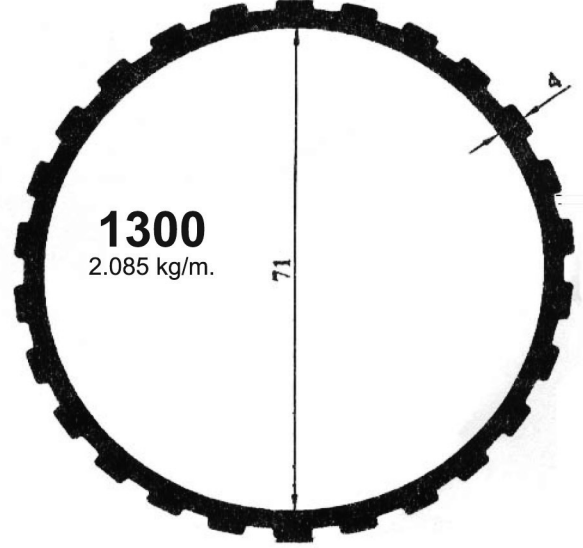
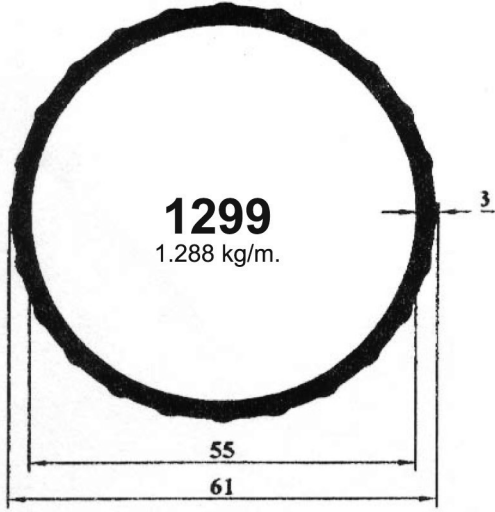



OSMANLI
ALÜMİNYUM SAN. ve TİC. LTD. ŞTİ.

- ❖ ÖZEL EBATLARDA BORU, KUTU, LAMA, KÖŞEBENT ÇEŞİTLERİ
- ❖ AYDINLATMA ve REKLAM PROFİLLERİ
- ❖ SOĞUTUCU ve LED PROFİLLERİ
- ❖ MOBİLYA ve SANAYİ PROFİLLERİ
- ❖ ÖZEL KALIP ÇİZİMLERİ ve İMALATI
- ❖ ELOKSALLI ve PRES PLAKA LEVHALARI
- ❖ GOFRAJLI ve DÜZ PARLAK RULO LEVHALARI
- ❖ LEVHA KESİM - BÜKÜM (ÖZEL ÖLÇÜLERİNİZDE)
- ❖ DELİKLİ ve DEKORATİF TELLER
- ❖ PLEXI - FOLYO - DEKOTE - POLYCARBON - KOMPOZİT VB.

Özel Profilleri

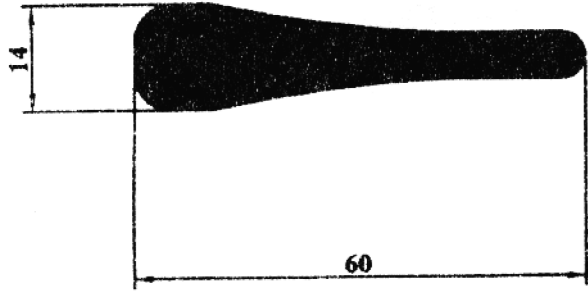

1296
(1.416 Kg/m)

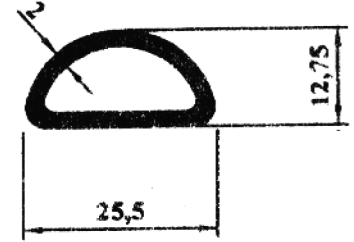

1297
(0.309 Kg/m)

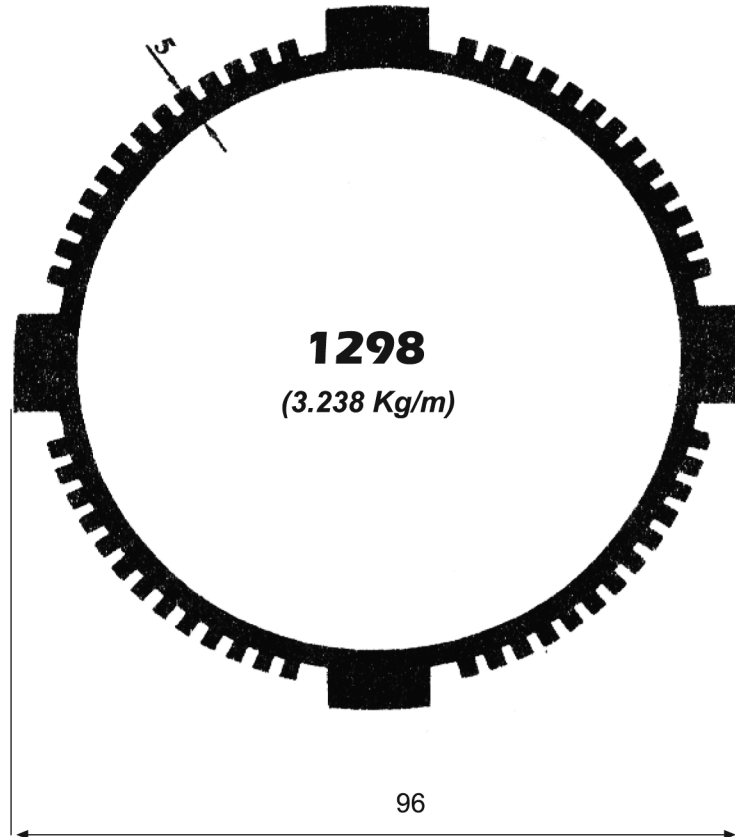

1298
(3.238 Kg/m)



OSMANLI
ALÜMİNYUM SAN. ve TİC. LTD .ŞTİ.

- ❖ ÖZEL EBATLARDA BORU, KUTU, LAMA, KÖŞEBENT ÇEŞİTLERİ
- ❖ AYDINLATMA ve REKLAM PROFİLLERİ
- ❖ SOĞUTUCU ve LED PROFİLLERİ
- ❖ MOBİLYA ve SANAYİ PROFİLLERİ
- ❖ ÖZEL KALIP ÇİZİMLERİ ve İMALATI
- ❖ ELOKSALLI ve PRES PLAKA LEVHALARI
- ❖ GOFRAJLI ve DÜZ PARLAK RULO LEVHALARI
- ❖ LEVHA KESİM - BÜKÜM (ÖZEL ÖLÇÜLERİNİZDE)
- ❖ DELİKLİ ve DEKORATİF TELLER
- ❖ PLEXI - FOLYO - DEKOTE - POLYCARBON - KOMPOZİT VB.

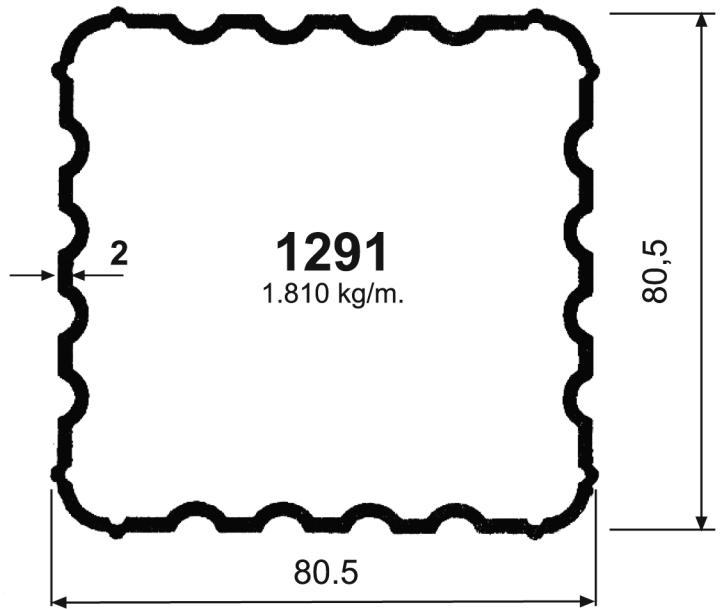
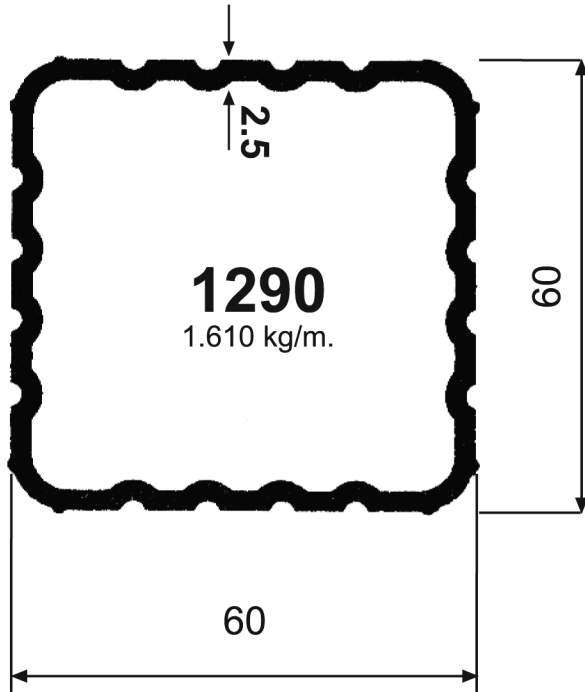
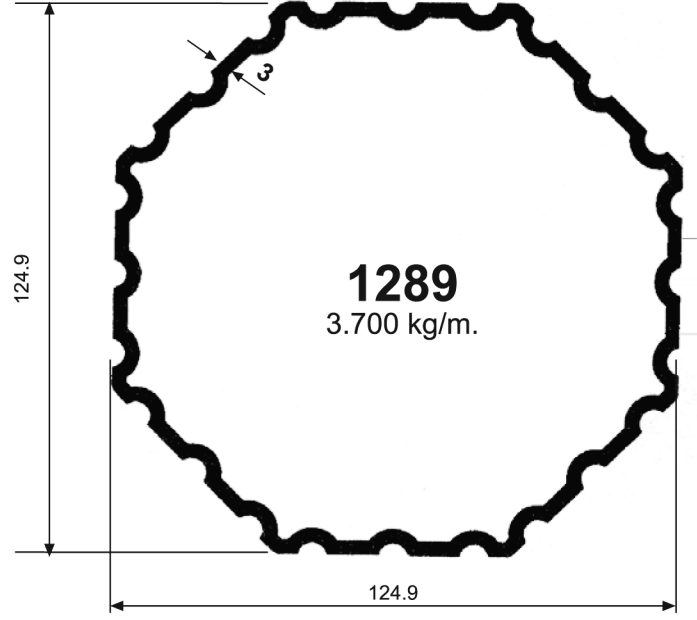
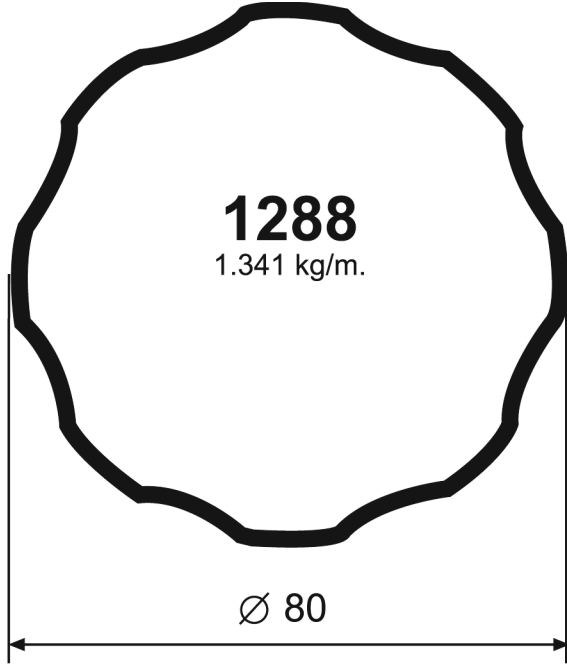



OSMANLI
ALÜMİNYUM SAN. ve TİC. LTD. ŞTİ.

- ❖ ÖZEL EBATLARDA BORU, KUTU, LAMA, KÖŞEBENT ÇEŞİTLERİ
- ❖ AYDINLATMA ve REKLAM PROFİLLERİ
- ❖ SOĞUTUCU ve LED PROFİLLERİ
- ❖ MOBİLYA ve SANAYİ PROFİLLERİ
- ❖ ÖZEL KALIP ÇİZİMLERİ ve İMALATI
- ❖ ELOKSALLI ve PRES PLAKA LEVHALARI
- ❖ GOFRAJLI ve DÜZ PARLAK RULO LEVHALARI
- ❖ LEVHA KESİM - BÜKÜM (ÖZEL ÖLÇÜLERİNİZDE)
- ❖ DELİKLİ ve DEKORATİF TELLER
- ❖ PLEXI - FOLYO - DEKOTE - POLYCARBON - KOMPOZİT VB.

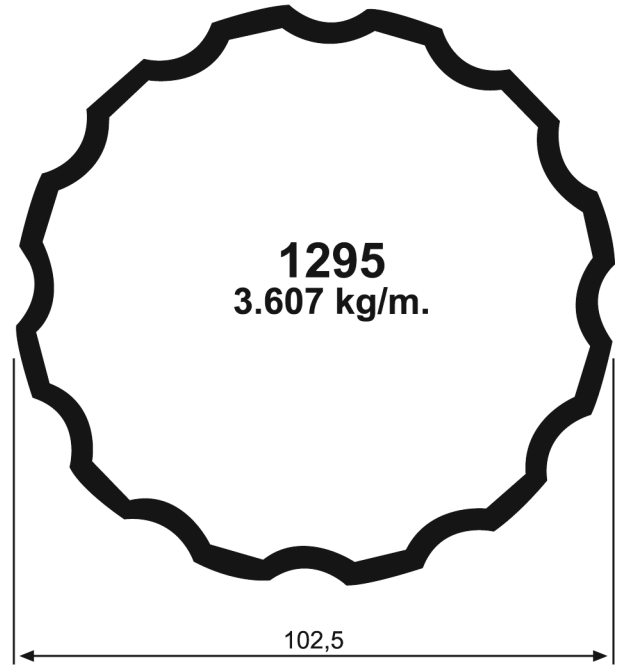
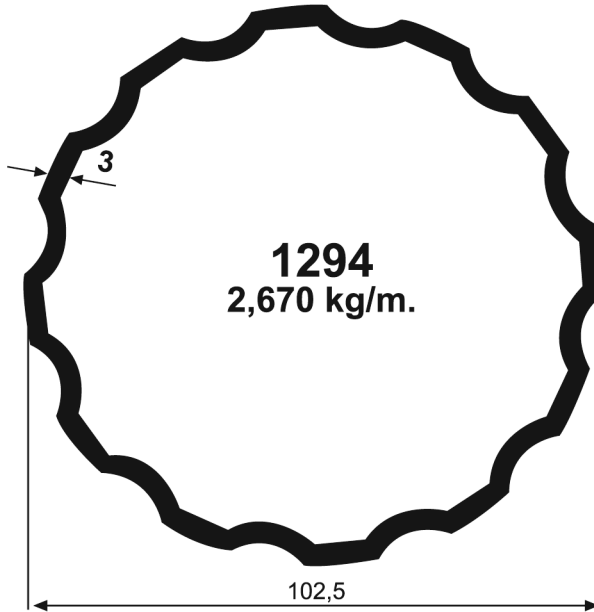
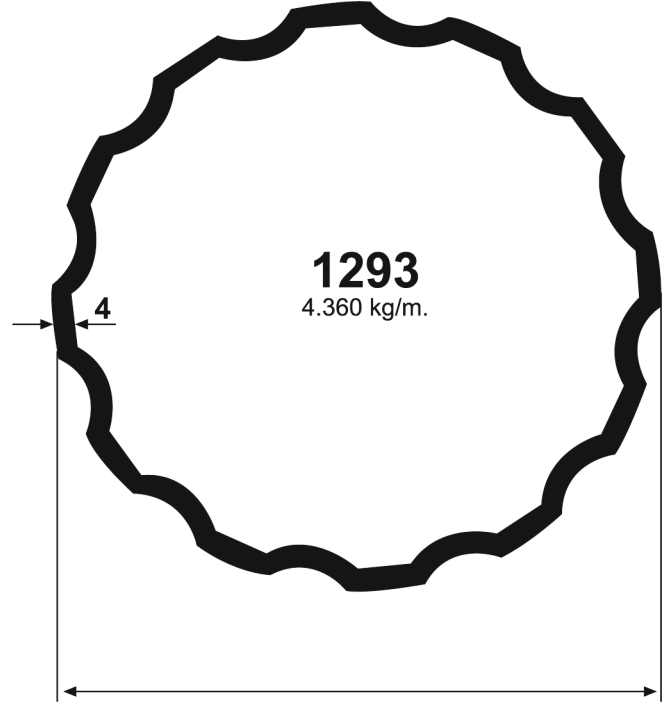
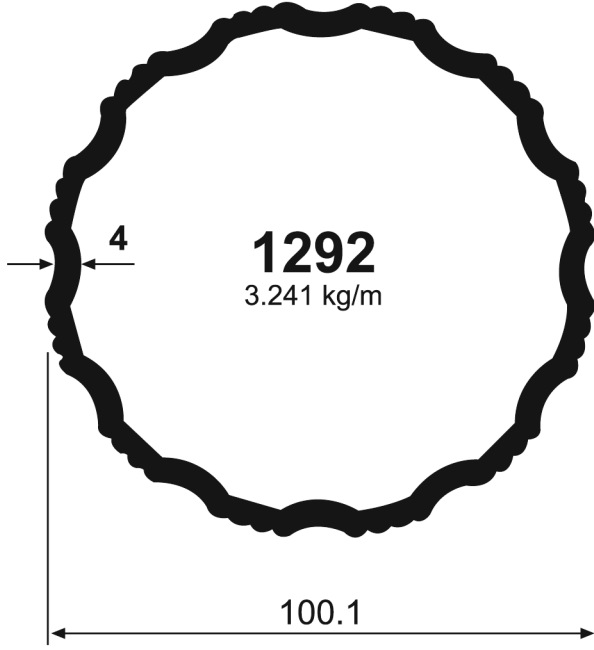



OSMANLI
ALÜMİNYUM SAN. ve TİC. LTD .ŞTİ.

- ❖ ÖZEL EBATLARDA BORU, KUTU, LAMA, KÖŞEBENT ÇEŞİTLERİ
- ❖ AYDINLATMA ve REKLAM PROFİLLERİ
- ❖ SOĞUTUCU ve LED PROFİLLERİ
- ❖ MOBİLYA ve SANAYİ PROFİLLERİ
- ❖ ÖZEL KALIP ÇİZİMLERİ ve İMALATI
- ❖ ELOKSALLI ve PRES PLAKA LEVHALARI
- ❖ GOFRAJLI ve DÜZ PARLAK RULO LEVHALARI
- ❖ LEVHA KESİM - BÜKÜM (ÖZEL ÖLÇÜLERİNİZDE)
- ❖ DELİKLİ ve DEKORATİF TELLER
- ❖ PLEXI - FOLYO - DEKOTE - POLYCARBON - KOMPOZİT VB.

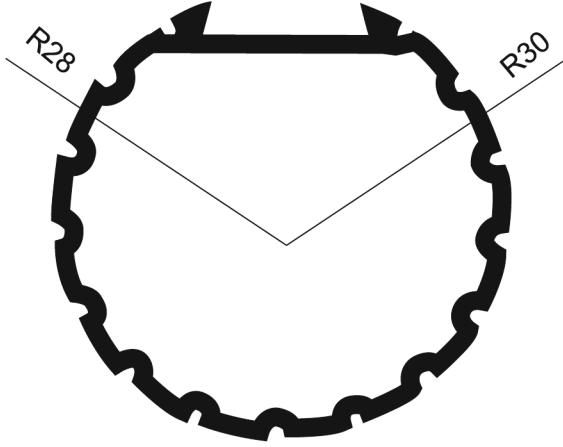

2388

(1,205 Kg/m)

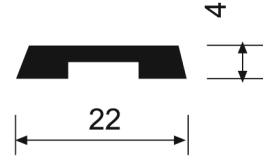

2389

(0,160 Kg/m)

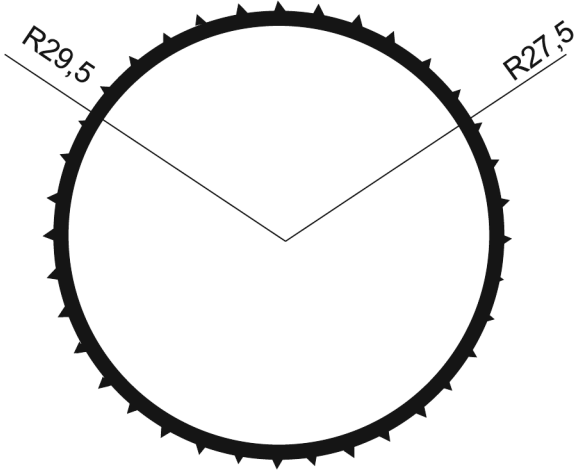

2390

(0,995 Kg/m)

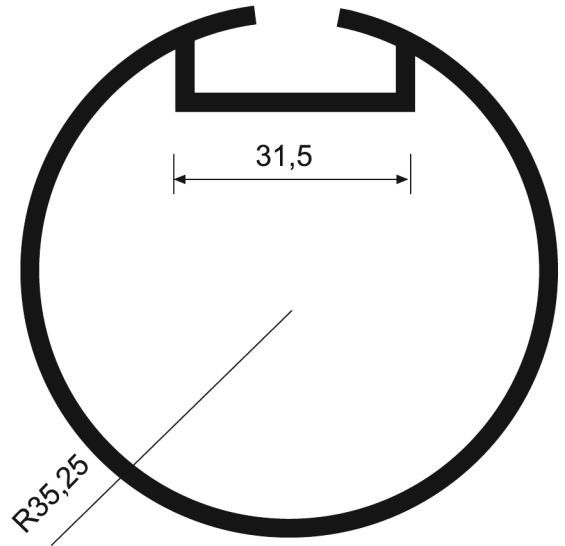

2391

(1,615 Kg/m)



OSMANLI
ALÜMİNYUM SAN. ve TİC. LTD .ŞTİ.

- ❖ ÖZEL EBATLARDA BORU, KUTU, LAMA, KÖŞEBENT ÇEŞİTLERİ
- ❖ AYDINLATMA ve REKLAM PROFİLLERİ
- ❖ SOĞUTUCU ve LED PROFİLLERİ
- ❖ MOBİLYA ve SANAYİ PROFİLLERİ
- ❖ ÖZEL KALIP ÇİZİMLERİ ve İMALATI
- ❖ ELOKSALLI ve PRES PLAKA LEVHALARI
- ❖ GOFRAJLI ve DÜZ PARLAK RULO LEVHALARI
- ❖ LEVHA KESİM - BÜKÜM (ÖZEL ÖLÇÜLERİNİZDE)
- ❖ DELİKLİ ve DEKORATİF TELLER
- ❖ PLEXI - FOLYO - DEKOTE - POLYCARBON - KOMPOZİT VB.

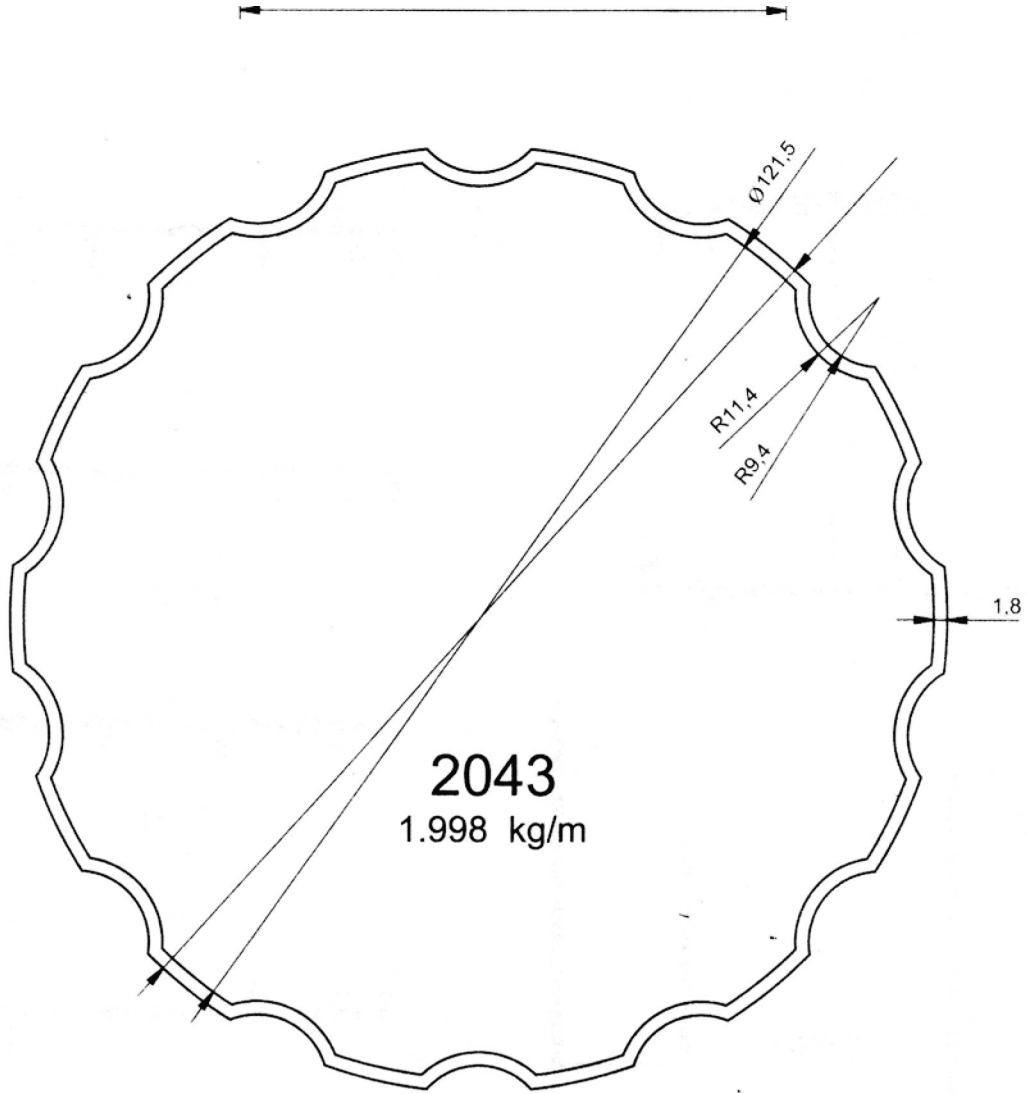

168



OSMANLI
ALÜMİNYUM SAN. ve TİC. LTD .ŞTİ.

- ❖ ÖZEL EBATLARDA BORU, KUTU, LAMA, KÖŞEBENT ÇEŞİTLERİ
- ❖ AYDINLATMA ve REKLAM PROFİLLERİ
- ❖ SOĞUTUCU ve LED PROFİLLERİ
- ❖ MOBİLYA ve SANAYİ PROFİLLERİ
- ❖ ÖZEL KALIP ÇİZİMLERİ ve İMALATI
- ❖ ELOKSALLI ve PRES PLAKA LEVHALARI
- ❖ GOFRAJLI ve DÜZ PARLAK RULO LEVHALARI
- ❖ LEVHA KESİM - BÜKÜM (ÖZEL ÖLÇÜLERİNİZDE)
- ❖ DELİKLİ ve DEKORATİF TELLER
- ❖ PLEXI - FOLYO - DEKOTE - POLYCARBON - KOMPOZİT VB.

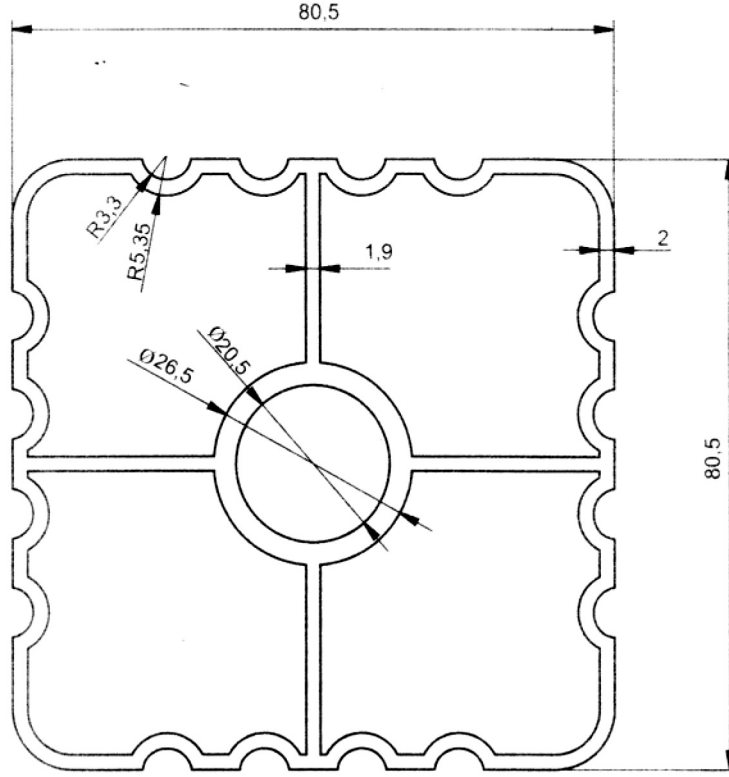

2040
2,972 kg/m

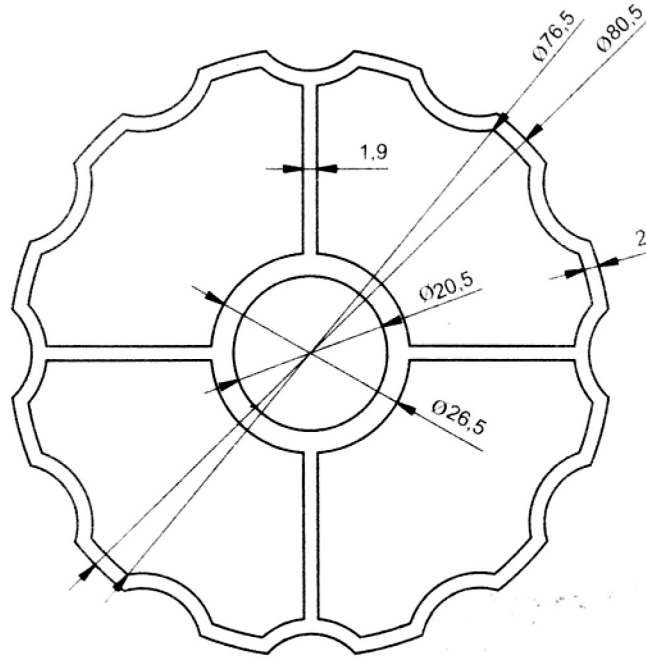

2041
2,472 kg/m



OSMANLI
ALÜMİNYUM SAN. ve TİC. LTD. ŞTİ.

- ❖ ÖZEL EBATLARDA BORU, KUTU, LAMA, KÖŞEBENT ÇEŞİTLERİ
- ❖ AYDINLATMA ve REKLAM PROFİLLERİ
- ❖ SOĞUTUCU ve LED PROFİLLERİ
- ❖ MOBİLYA ve SANAYİ PROFİLLERİ
- ❖ ÖZEL KALIP ÇİZİMLERİ ve İMALATI
- ❖ ELOKSALLI ve PRES PLAKA LEVHALARI
- ❖ GOFRAJLI ve DÜZ PARLAK RULO LEVHALARI
- ❖ LEVHA KESİM - BÜKÜM (ÖZEL ÖLÇÜLERİNİZDE)
- ❖ DELİKLİ ve DEKORATİF TELLER
- ❖ PLEXI - FOLYO - DEKOTE - POLYCARBON - KOMPOZİT VB.

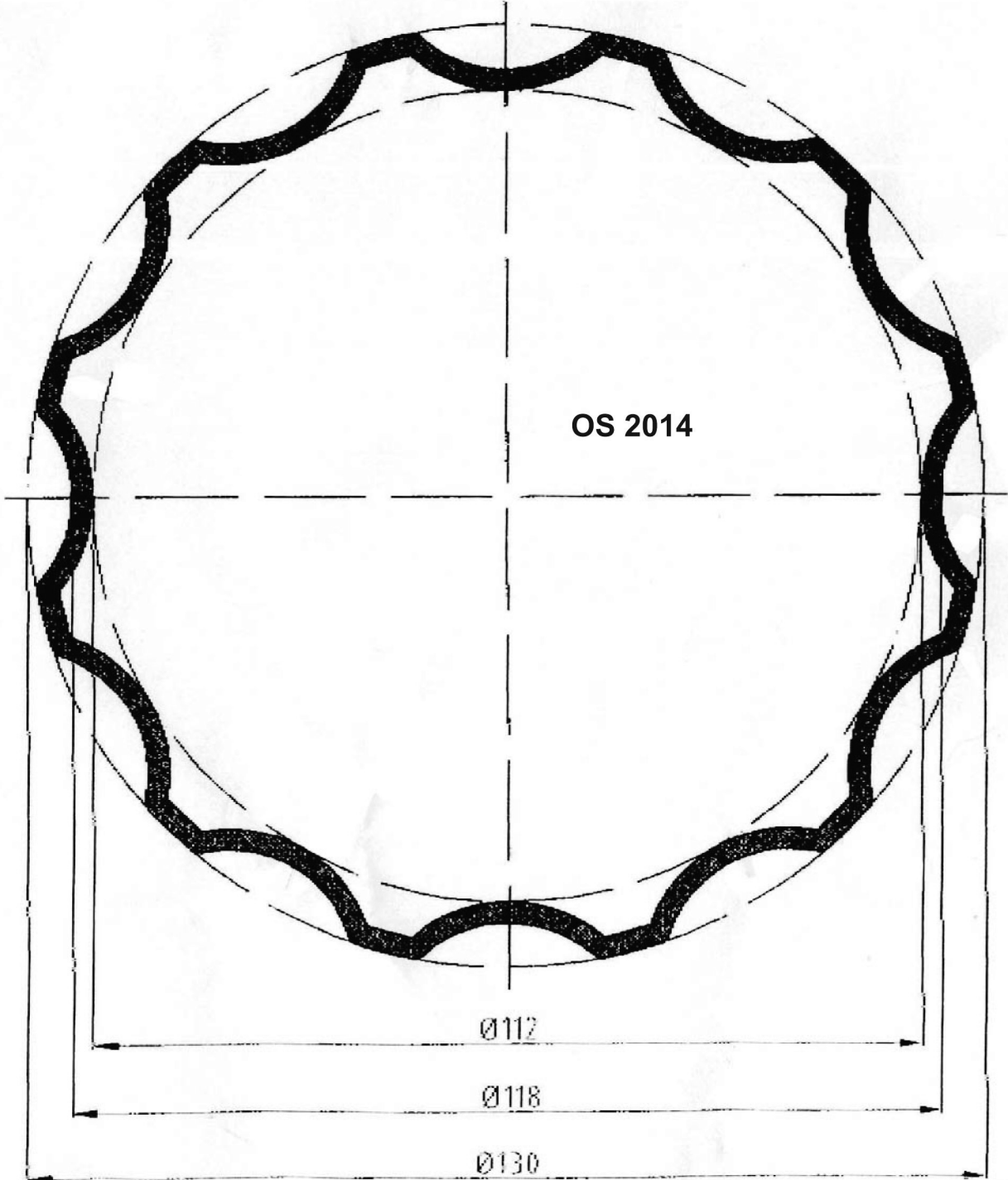

OS 2013



OSMANLI
ALÜMİNYUM SAN. ve TİC. LTD .ŞTİ.

- ❖ ÖZEL EBATLARDA BORU, KUTU, LAMA, KÖŞEBENT ÇEŞİTLERİ
- ❖ AYDINLATMA ve REKLAM PROFİLLERİ
- ❖ SOĞUTUCU ve LED PROFİLLERİ
- ❖ MOBİLYA ve SANAYİ PROFİLLERİ
- ❖ ÖZEL KALIP ÇİZİMLERİ ve İMALATI
- ❖ ELOKSALLI ve PRES PLAKA LEVHALARI
- ❖ GOFRAJLI ve DÜZ PARLAK RULO LEVHALARI
- ❖ LEVHA KESİM - BÜKÜM (ÖZEL ÖLÇÜLERİNİZDE)
- ❖ DELİKLİ ve DEKORATİF TELLER
- ❖ PLEXI - FOLYO - DEKOTE - POLYCARBON - KOMPOZİT VB.

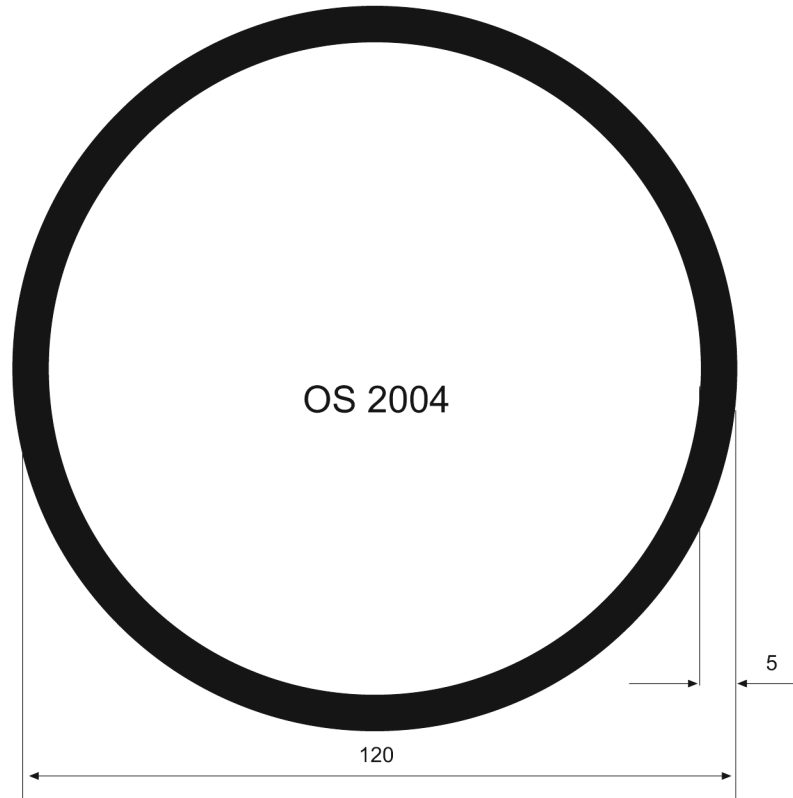
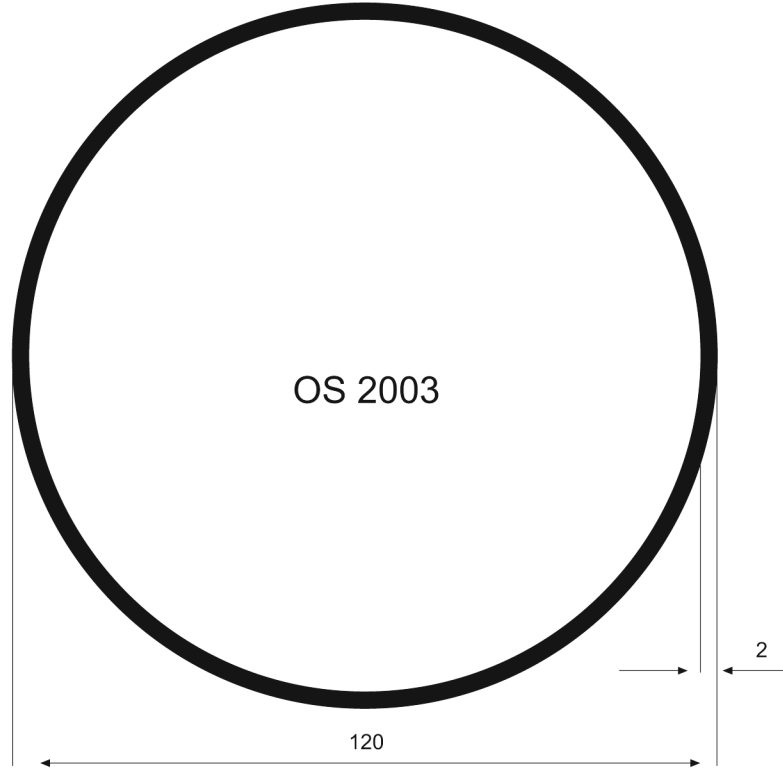



OSMANLI
ALÜMİNYUM SAN. ve TİC. LTD .ŞTİ.

- ❖ ÖZEL EBATLARDA BORU, KUTU, LAMA, KÖŞEBENT ÇEŞİTLERİ
- ❖ AYDINLATMA ve REKLAM PROFİLLERİ
- ❖ SOĞUTUCU ve LED PROFİLLERİ
- ❖ MOBİLYA ve SANAYİ PROFİLLERİ
- ❖ ÖZEL KALIP ÇİZİMLERİ ve İMALATI
- ❖ ELOKSALLI ve PRES PLAKA LEVHALARI
- ❖ GOFRAJLI ve DÜZ PARLAK RULO LEVHALARI
- ❖ LEVHA KESİM - BÜKÜM (ÖZEL ÖLÇÜLERİNİZDE)
- ❖ DELİKLİ ve DEKORATİF TELLER
- ❖ PLEXI - FOLYO - DEKOTE - POLYCARBON - KOMPOZİT VB.

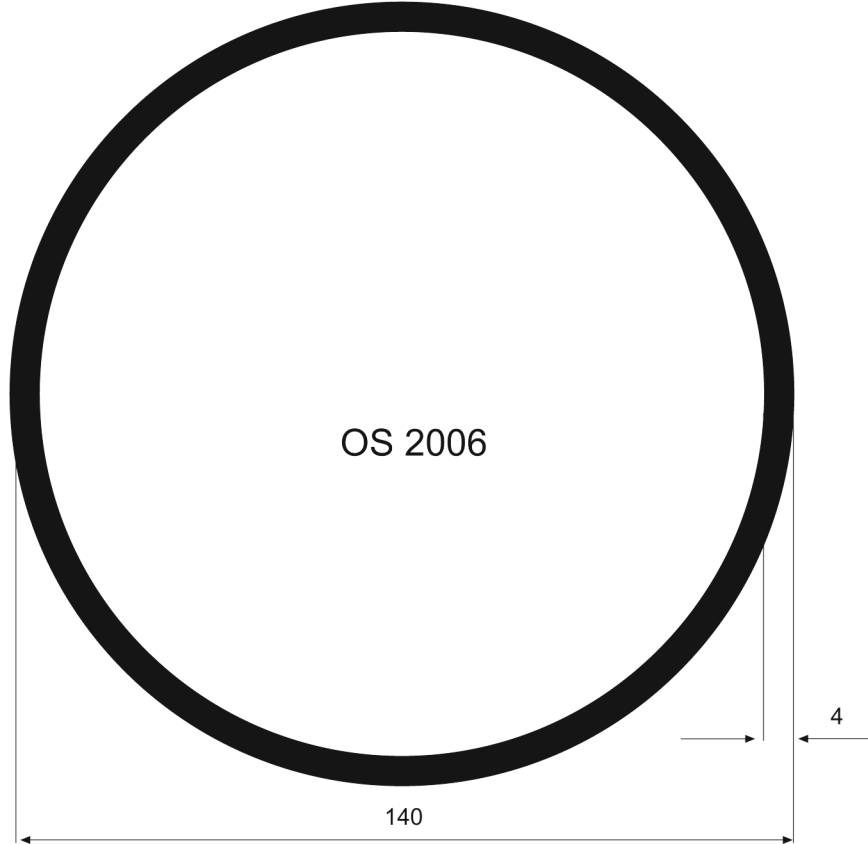
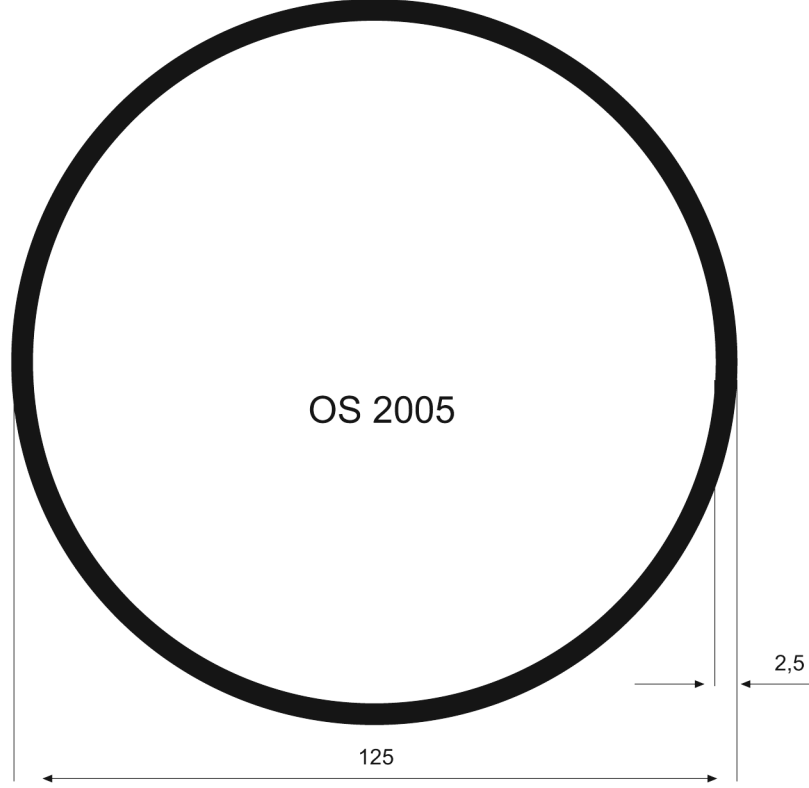



OSMANLI
ALÜMİNYUM SAN. ve TİC. LTD .ŞTİ.

- ❖ ÖZEL EBATLARDA BORU, KUTU, LAMA, KÖŞEBENT ÇEŞİTLERİ
- ❖ AYDINLATMA ve REKLAM PROFİLLERİ
- ❖ SOĞUTUCU ve LED PROFİLLERİ
- ❖ MOBİLYA ve SANAYİ PROFİLLERİ
- ❖ ÖZEL KALIP ÇİZİMLERİ ve İMALATI
- ❖ ELOKSALLI ve PRES PLAKA LEVHALARI
- ❖ GOFRAJLI ve DÜZ PARLAK RULO LEVHALARI
- ❖ LEVHA KESİM - BÜKÜM (ÖZEL ÖLÇÜLERİNİZDE)
- ❖ DELİKLİ ve DEKORATİF TELLER
- ❖ PLEXI - FOLYO - DEKOTE - POLYCARBON - KOMPOZİT VB.

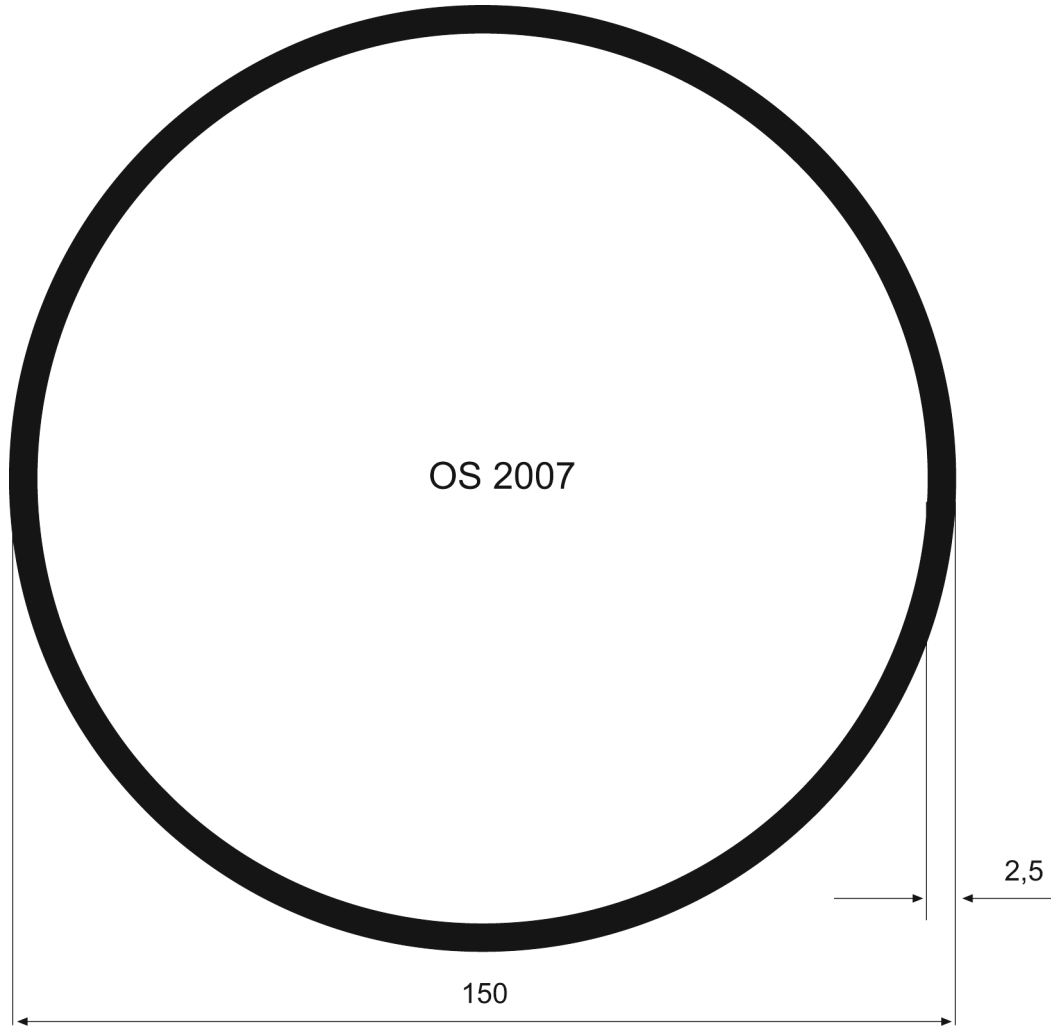



OSMANLI
ALÜMİNYUM SAN. ve TİC. LTD .ŞTİ.

- ❖ ÖZEL EBATLARDA BORU, KUTU, LAMA, KÖŞEBENT ÇEŞİTLERİ
- ❖ AYDINLATMA ve REKLAM PROFİLLERİ
- ❖ SOĞUTUCU ve LED PROFİLLERİ
- ❖ MOBİLYA ve SANAYİ PROFİLLERİ
- ❖ ÖZEL KALIP ÇİZİMLERİ ve İMALATI
- ❖ ELOKSALLI ve PRES PLAKA LEVHALARI
- ❖ GOFRAJLI ve DÜZ PARLAK RULO LEVHALARI
- ❖ LEVHA KESİM - BÜKÜM (ÖZEL ÖLÇÜLERİNİZDE)
- ❖ DELİKLİ ve DEKORATİF TELLER
- ❖ PLEXI - FOLYO - DEKOTE - POLYCARBON - KOMPOZİT VB.

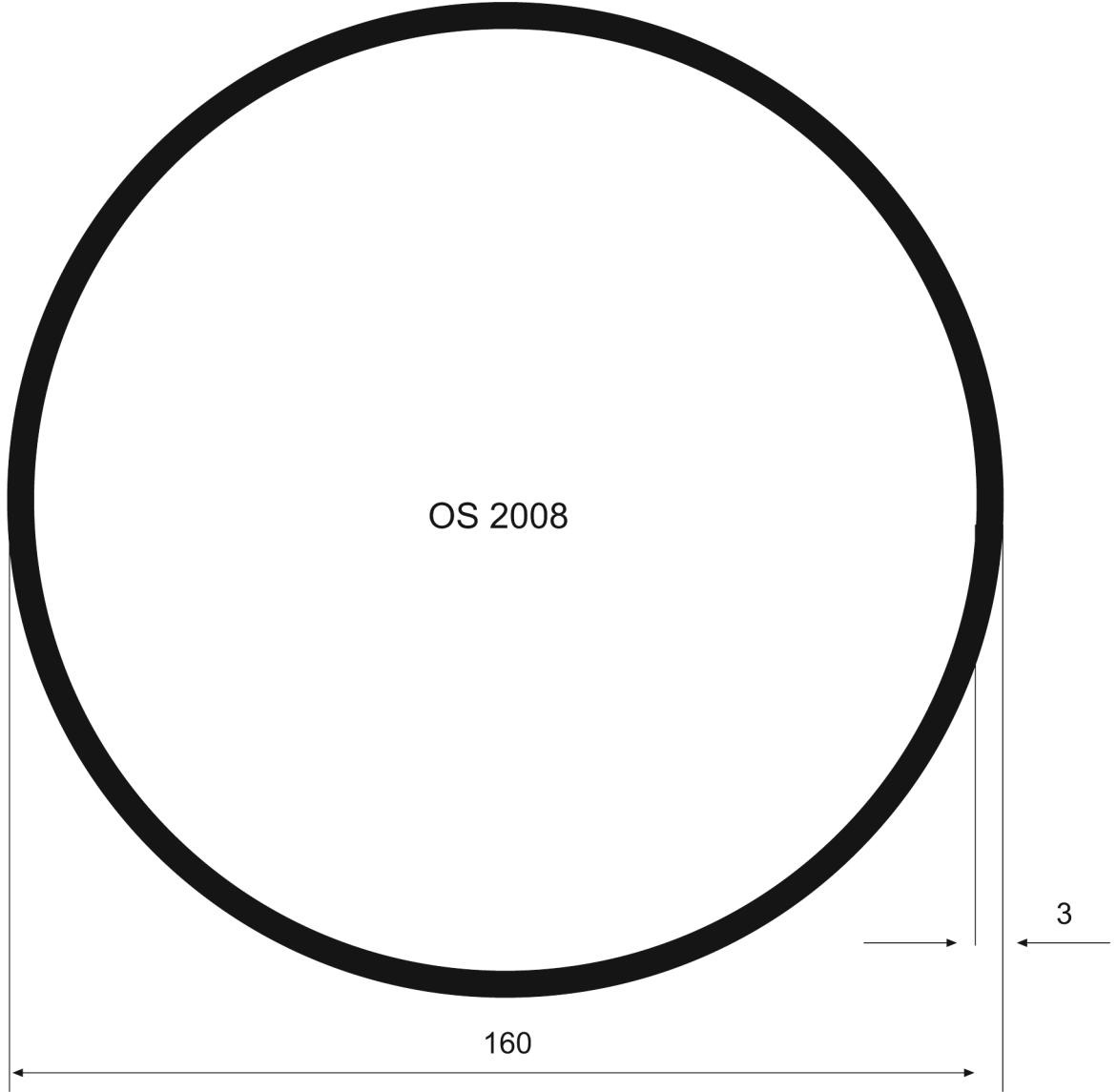



OSMANLI
ALÜMİNYUM SAN. ve TİC. LTD .ŞTİ.

- ❖ ÖZEL EBATLARDA BORU, KUTU, LAMA, KÖŞEBENT ÇEŞİTLERİ
- ❖ AYDINLATMA ve REKLAM PROFİLLERİ
- ❖ SOĞUTUCU ve LED PROFİLLERİ
- ❖ MOBİLYA ve SANAYİ PROFİLLERİ
- ❖ ÖZEL KALIP ÇİZİMLERİ ve İMALATI
- ❖ ELOKSALLI ve PRES PLAKA LEVHALARI
- ❖ GOFRAJLI ve DÜZ PARLAK RULO LEVHALARI
- ❖ LEVHA KESİM - BÜKÜM (ÖZEL ÖLÇÜLERİNİZDE)
- ❖ DELİKLİ ve DEKORATİF TELLER
- ❖ PLEXI - FOLYO - DEKOTE - POLYCARBON - KOMPOZİT VB.

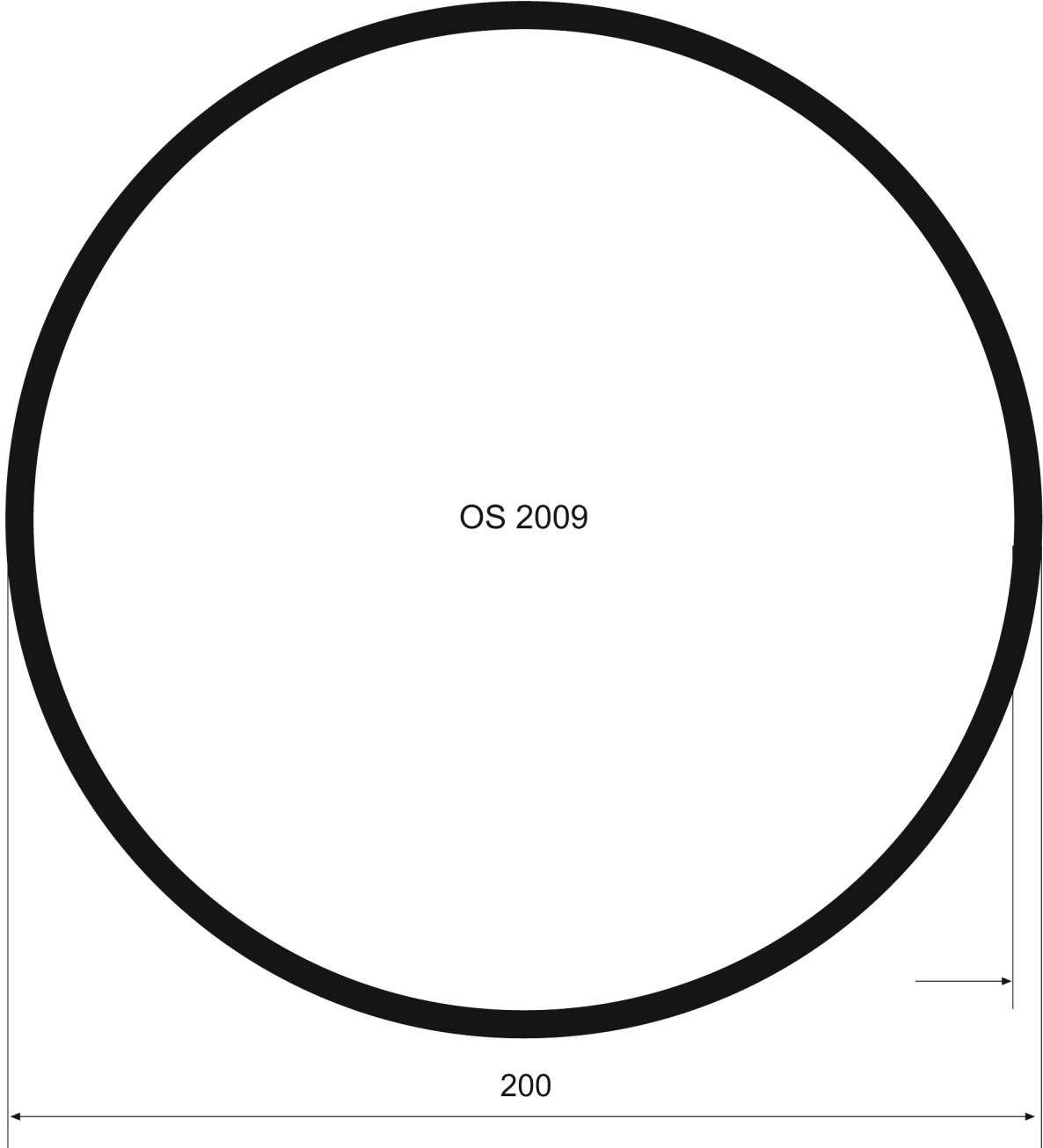



OSMANLI
ALÜMİNYUM SAN. ve TİC. LTD .ŞTİ.

- ❖ ÖZEL EBATLARDA BORU, KUTU, LAMA, KÖŞEBENT ÇEŞİTLERİ
- ❖ AYDINLATMA ve REKLAM PROFİLLERİ
- ❖ SOĞUTUCU ve LED PROFİLLERİ
- ❖ MOBİLYA ve SANAYİ PROFİLLERİ
- ❖ ÖZEL KALIP ÇİZİMLERİ ve İMALATI
- ❖ ELOKSALLI ve PRES PLAKA LEVHALARI
- ❖ GOFRAJLI ve DÜZ PARLAK RULO LEVHALARI
- ❖ LEVHA KESİM - BÜKÜM (ÖZEL ÖLÇÜLERİNİZDE)
- ❖ DELİKLİ ve DEKORATİF TELLER
- ❖ PLEXI - FOLYO - DEKOTE - POLYCARBON - KOMPOZİT VB.

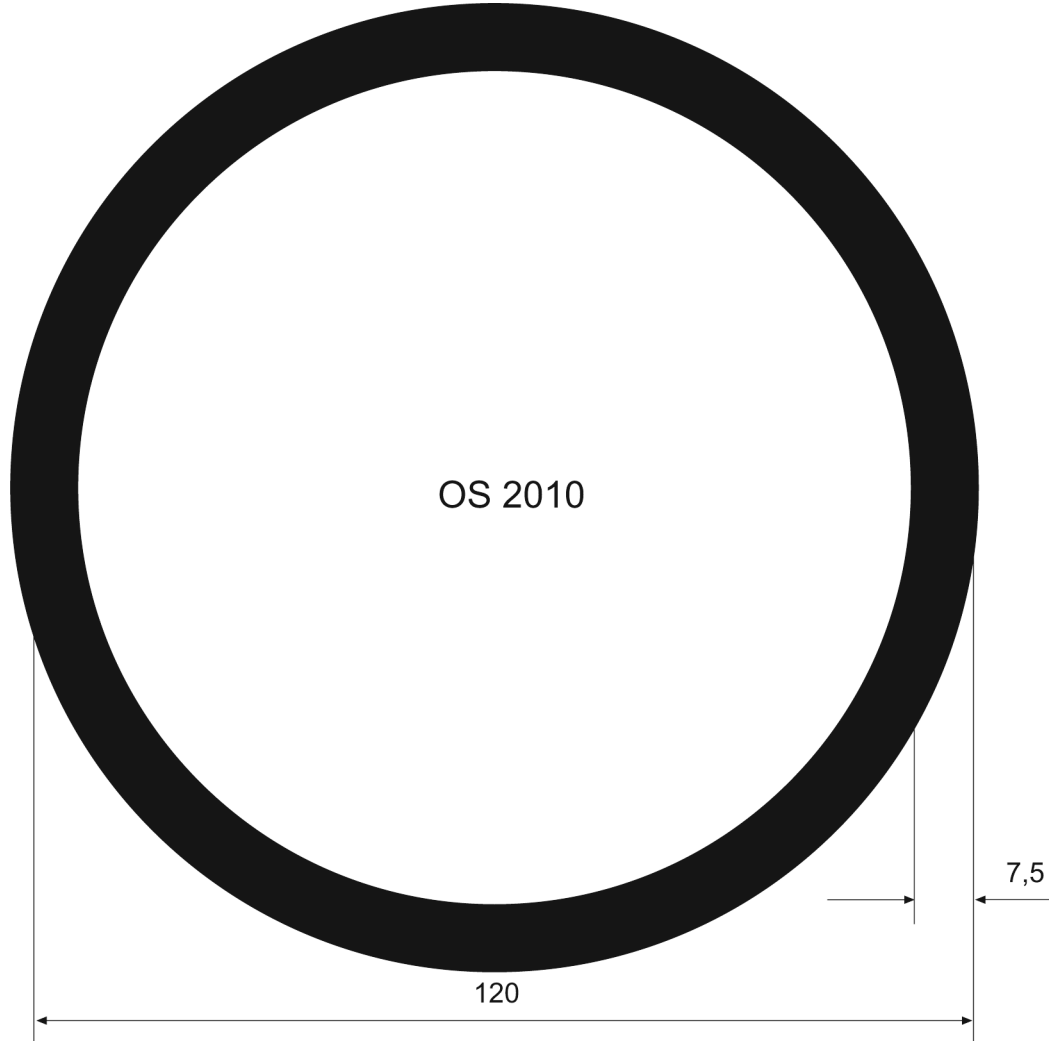



OSMANLI
ALÜMİNYUM SAN. ve TİC. LTD. ŞTİ.

- ❖ ÖZEL EBATLARDA BORU, KUTU, LAMA, KÖŞEBENT ÇEŞİTLERİ
- ❖ AYDINLATMA ve REKLAM PROFİLLERİ
- ❖ SOĞUTUCU ve LED PROFİLLERİ
- ❖ MOBİLYA ve SANAYİ PROFİLLERİ
- ❖ ÖZEL KALIP ÇİZİMLERİ ve İMALATI
- ❖ ELOKSALLI ve PRES PLAKA LEVHALARI
- ❖ GOFRAJLI ve DÜZ PARLAK RULO LEVHALARI
- ❖ LEVHA KESİM - BÜKÜM (ÖZEL ÖLÇÜLERİNİZDE)
- ❖ DELİKLİ ve DEKORATİF TELLER
- ❖ PLEXI - FOLYO - DEKOTE - POLYCARBON - KOMPOZİT VB.

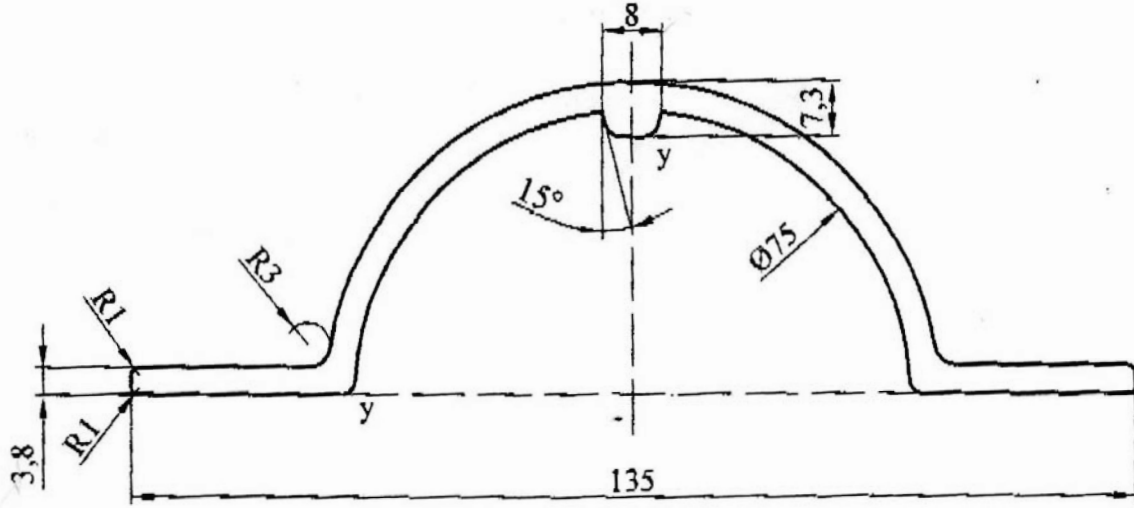

OS 2016

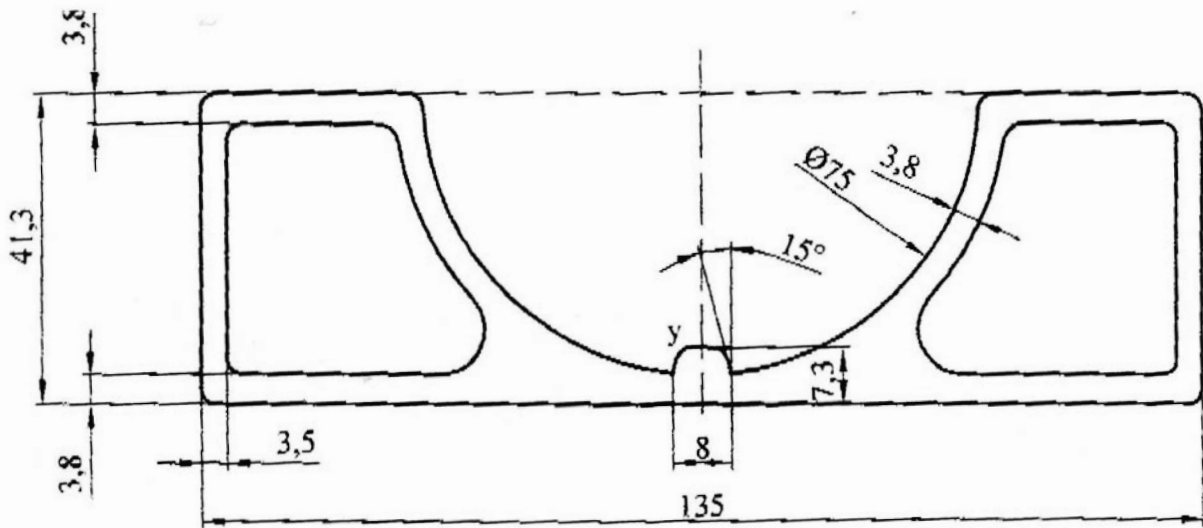

OS 2017



OSMANLI
ALÜMİNYUM SAN. ve TİC. LTD .ŞTİ.

- ❖ ÖZEL EBATLARDA BORU, KUTU, LAMA, KÖŞEBENT ÇEŞİTLERİ
- ❖ AYDINLATMA ve REKLAM PROFİLLERİ
- ❖ SOĞUTUCU ve LED PROFİLLERİ
- ❖ MOBİLYA ve SANAYİ PROFİLLERİ
- ❖ ÖZEL KALIP ÇİZİMLERİ ve İMALATI
- ❖ ELOKSALLI ve PRES PLAKA LEVHALARI
- ❖ GOFRAJLI ve DÜZ PARLAK RULO LEVHALARI
- ❖ LEVHA KESİM - BÜKÜM (ÖZEL ÖLÇÜLERİNİZDE)
- ❖ DELİKLİ ve DEKORATİF TELLER
- ❖ PLEXI - FOLYO - DEKOTE - POLYCARBON - KOMPOZİT VB.

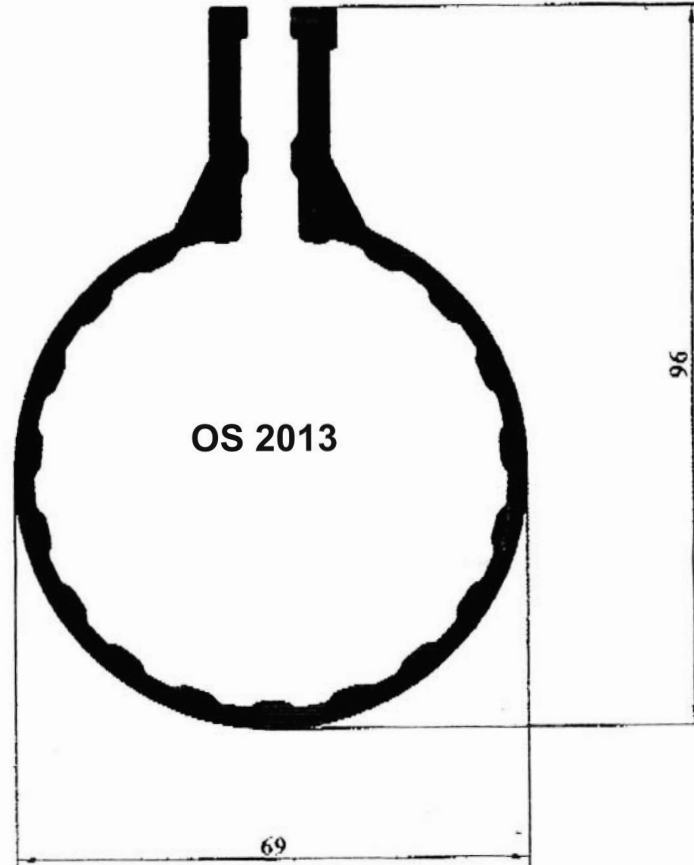
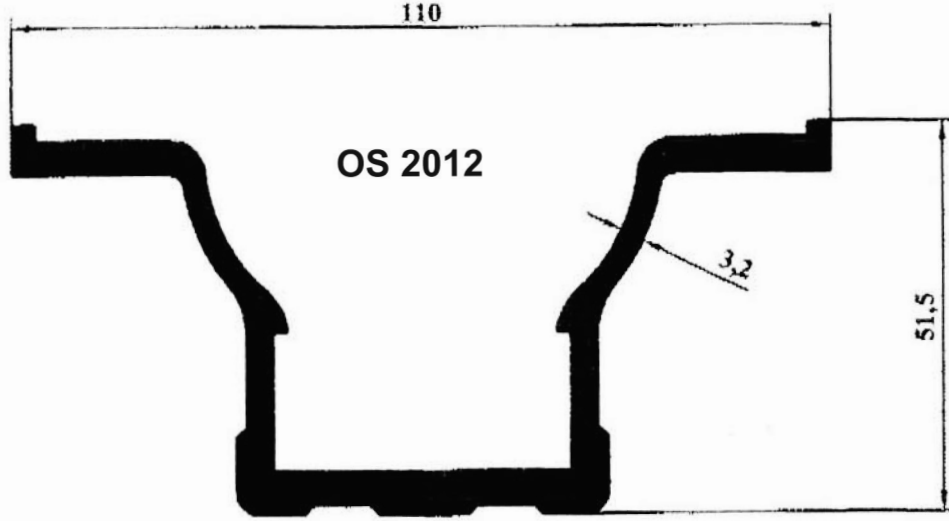



OSMANLI
ALÜMİNYUM SAN. ve TİC. LTD. ŞTİ.

- ❖ ÖZEL EBATLARDA BORU, KUTU, LAMA, KÖŞEBENT ÇEŞİTLERİ
- ❖ AYDINLATMA ve REKLAM PROFİLLERİ
- ❖ SOĞUTUCU ve LED PROFİLLERİ
- ❖ MOBİLYA ve SANAYİ PROFİLLERİ
- ❖ ÖZEL KALIP ÇİZİMLERİ ve İMALATI
- ❖ ELOKSALLI ve PRES PLAKA LEVHALARI
- ❖ GOFRAJLI ve DÜZ PARLAK RULO LEVHALARI
- ❖ LEVHA KESİM - BÜKÜM (ÖZEL ÖLÇÜLERİNİZDE)
- ❖ DELİKLİ ve DEKORATİF TELLER
- ❖ PLEXI - FOLYO - DEKOTE - POLYCARBON - KOMPOZİT VB.

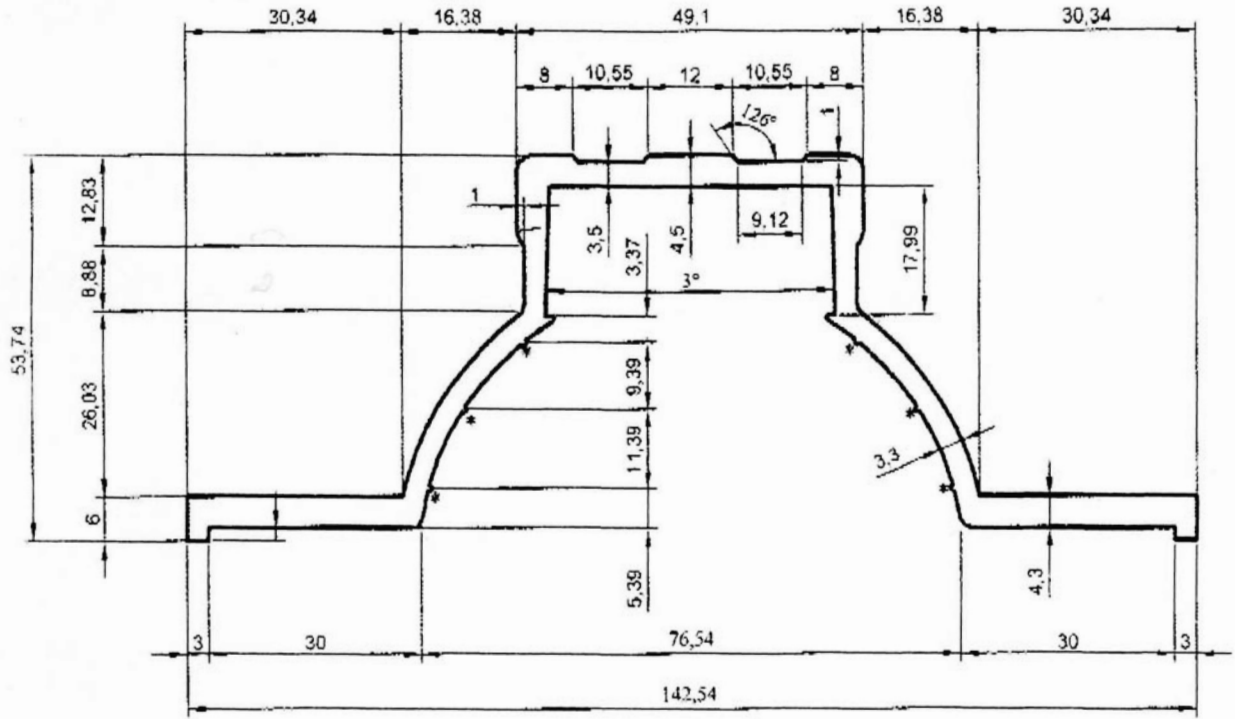

OS 2018

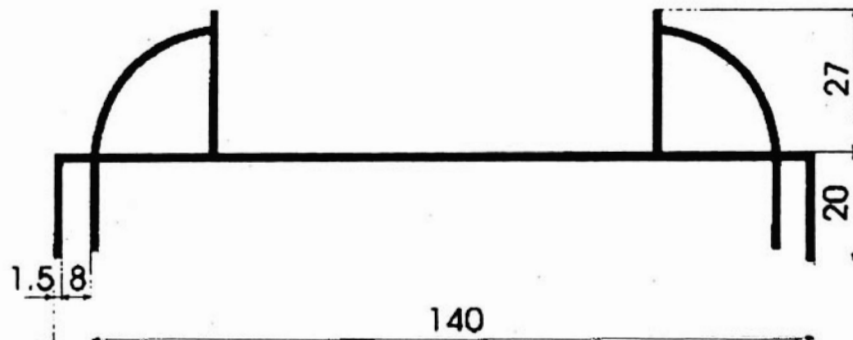

Profil No. 6240
1.360 Kg/m



OSMANLI
ALÜMİNYUM SAN. ve TİC. LTD .ŞTİ.

- ❖ ÖZEL EBATLARDA BORU, KUTU, LAMA, KÖŞEBENT ÇEŞİTLERİ
- ❖ AYDINLATMA ve REKLAM PROFİLLERİ
- ❖ SOĞUTUCU ve LED PROFİLLERİ
- ❖ MOBİLYA ve SANAYİ PROFİLLERİ
- ❖ ÖZEL KALIP ÇİZİMLERİ ve İMALATI
- ❖ ELOKSALLI ve PRES PLAKA LEVHALARI
- ❖ GOFRAJLI ve DÜZ PARLAK RULO LEVHALARI
- ❖ LEVHA KESİM - BÜKÜM (ÖZEL ÖLÇÜLERİNİZDE)
- ❖ DELİKLİ ve DEKORATİF TELLER
- ❖ PLEXI - FOLYO - DEKOTE - POLYCARBON - KOMPOZİT VB.

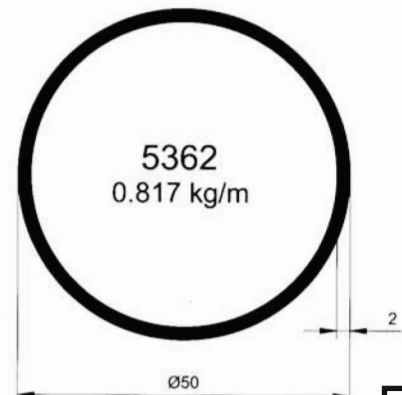
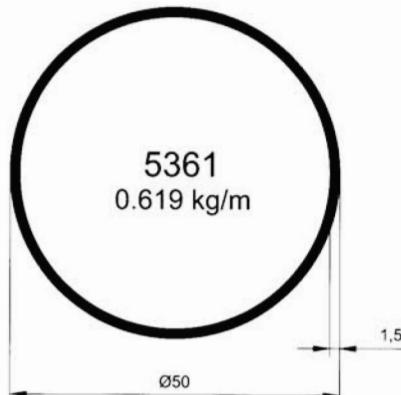
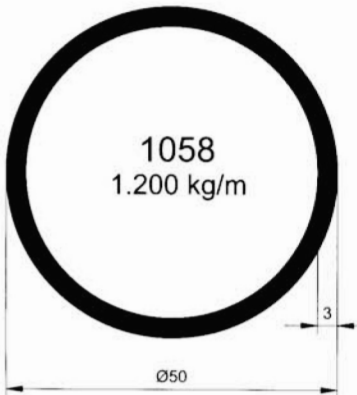
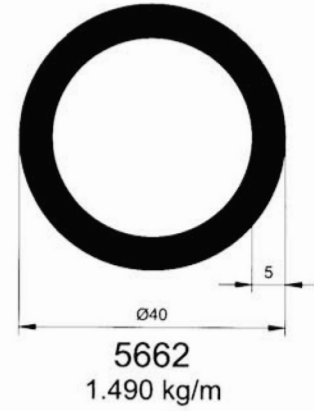
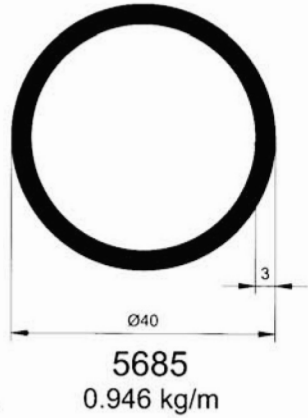
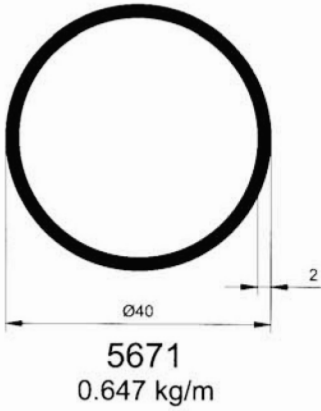
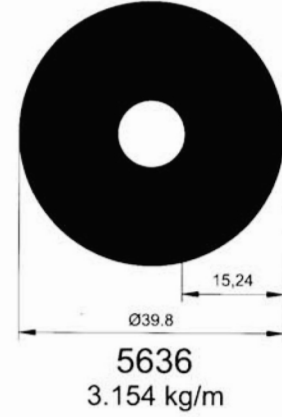
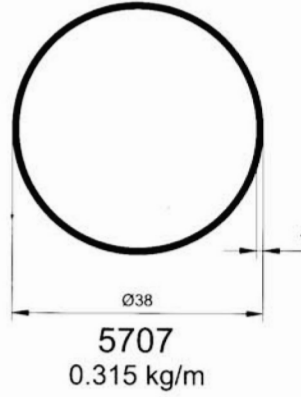
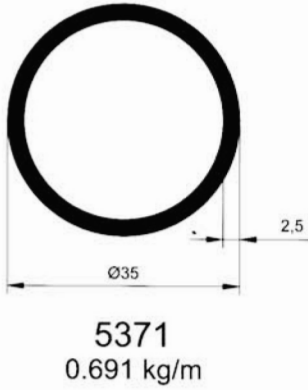
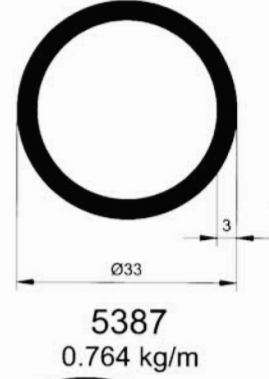
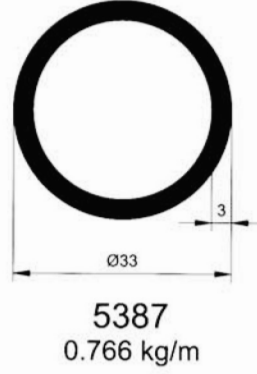
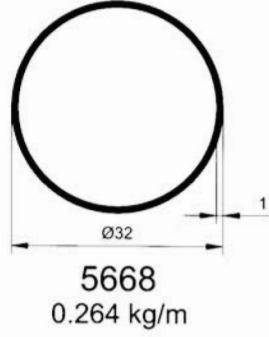
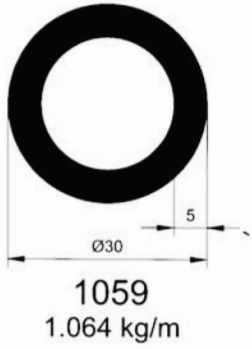



OSMANLI
ALÜMİNYUM SAN. ve TİC. LTD .ŞTİ.

- ❖ ÖZEL EBATLARDA BORU, KUTU, LAMA, KÖŞEBENT ÇEŞİTLERİ
- ❖ AYDINLATMA ve REKLAM PROFİLLERİ
- ❖ SOĞUTUCU ve LED PROFİLLERİ
- ❖ MOBİLYA ve SANAYİ PROFİLLERİ
- ❖ ÖZEL KALIP ÇİZİMLERİ ve İMALATI
- ❖ ELOKSALLI ve PRES PLAKA LEVHALARI
- ❖ GOFRAJLI ve DÜZ PARLAK RULO LEVHALARI
- ❖ LEVHA KESİM - BÜKÜM (ÖZEL ÖLÇÜLERİNİZDE)
- ❖ DELİKLİ ve DEKORATİF TELLER
- ❖ PLEXI - FOLYO - DEKOTE - POLYCARBON - KOMPOZİT VB.

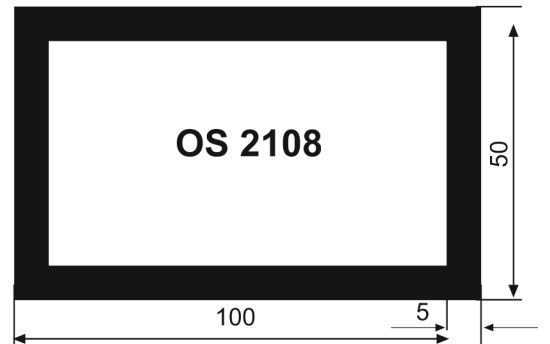
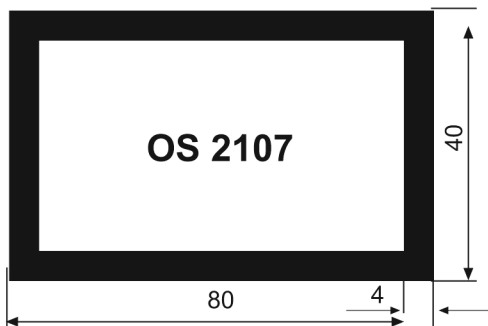
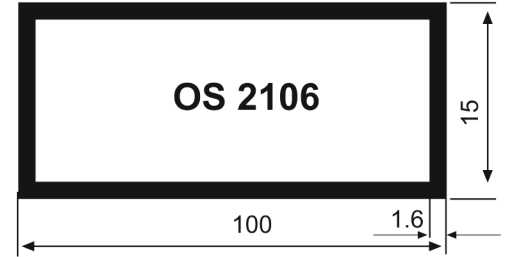
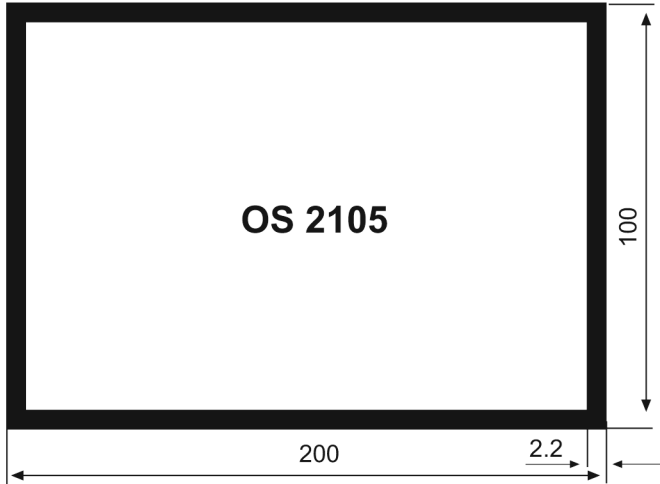
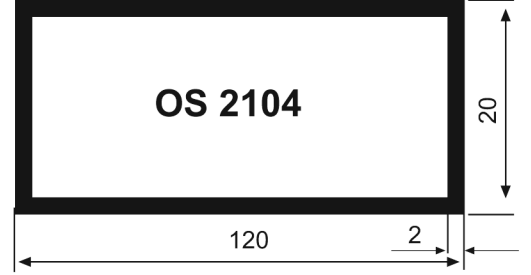
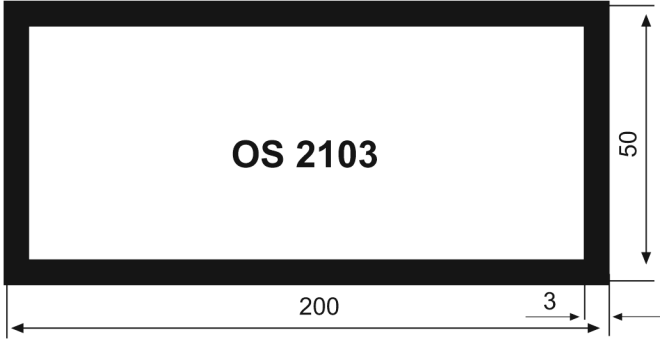
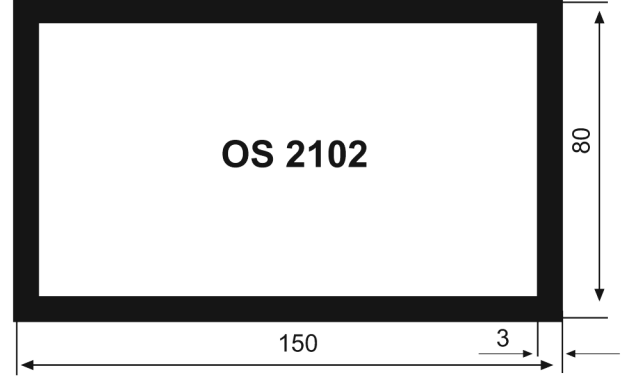
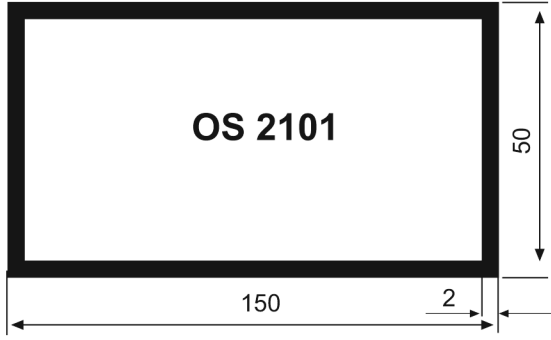



OSMANLI
ALÜMİNYUM SAN. ve TİC. LTD .ŞTİ.

- ❖ ÖZEL EBATLARDA BORU, KUTU, LAMA, KÖŞEBENT ÇEŞİTLERİ
- ❖ AYDINLATMA ve REKLAM PROFİLLERİ
- ❖ SOĞUTUCU ve LED PROFİLLERİ
- ❖ MOBİLYA ve SANAYİ PROFİLLERİ
- ❖ ÖZEL KALIP ÇİZİMLERİ ve İMALATI
- ❖ ELOKSALLI ve PRES PLAKA LEVHALARI
- ❖ GOFRAJLI ve DÜZ PARLAK RULO LEVHALARI
- ❖ LEVHA KESİM - BÜKÜM (ÖZEL ÖLÇÜLERİNİZDE)
- ❖ DELİKLİ ve DEKORATİF TELLER
- ❖ PLEXI - FOLYO - DEKOTE - POLYCARBON - KOMPOZİT VB.

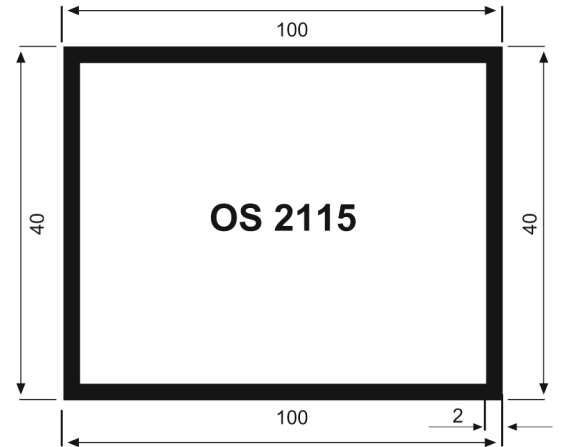
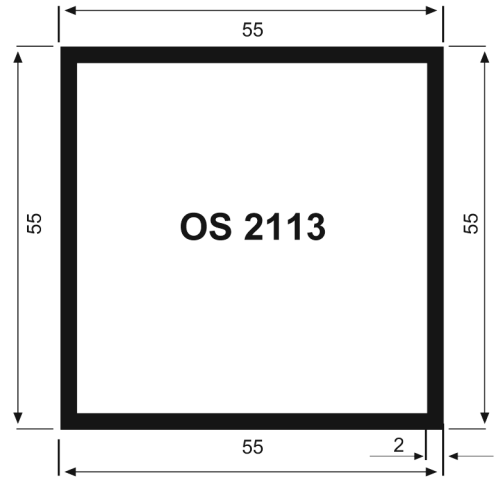
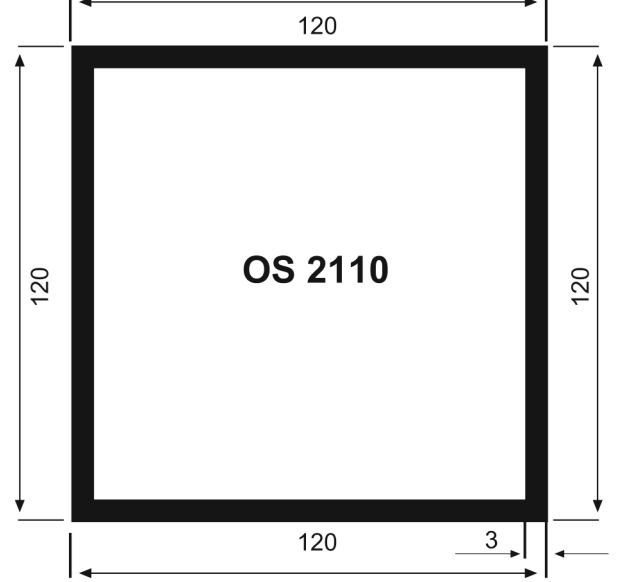
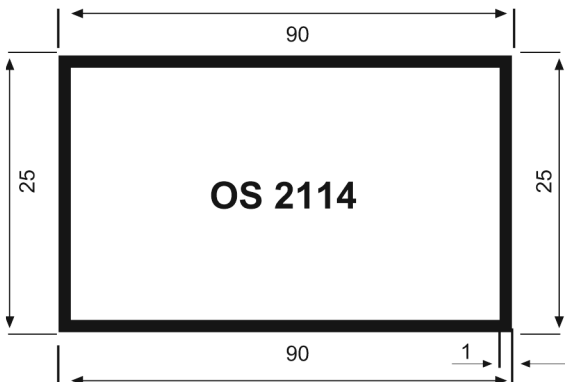
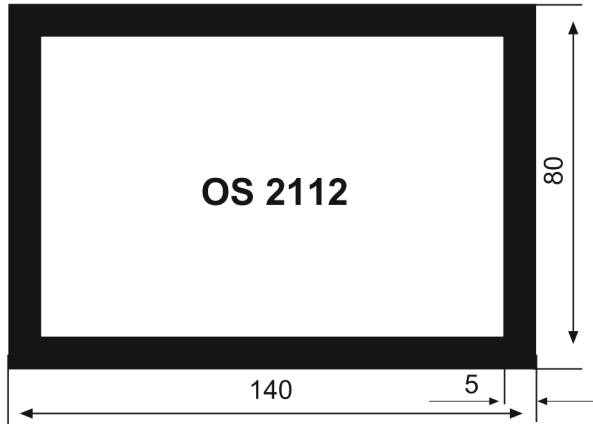
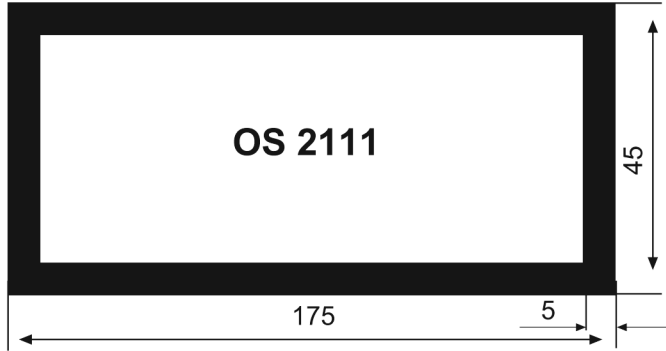
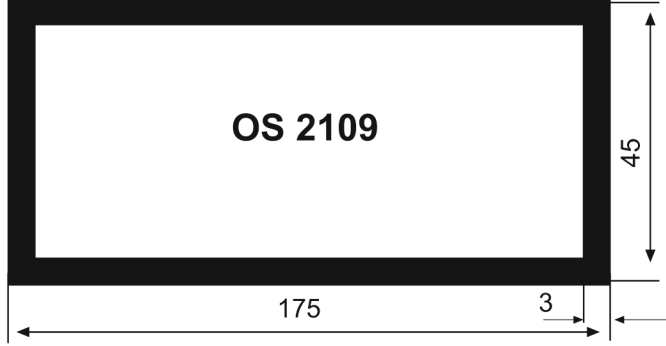



OSMANLI
ALÜMİNYUM SAN. ve TİC. LTD .ŞTİ.

- ❖ ÖZEL EBATLARDA BORU, KUTU, LAMA, KÖŞEBENT ÇEŞİTLERİ
- ❖ AYDINLATMA ve REKLAM PROFİLLERİ
- ❖ SOĞUTUCU ve LED PROFİLLERİ
- ❖ MOBİLYA ve SANAYİ PROFİLLERİ
- ❖ ÖZEL KALIP ÇİZİMLERİ ve İMALATI
- ❖ ELOKSALLI ve PRES PLAKA LEVHALARI
- ❖ GOFRAJLI ve DÜZ PARLAK RULO LEVHALARI
- ❖ LEVHA KESİM - BÜKÜM (ÖZEL ÖLÇÜLERİNİZDE)
- ❖ DELİKLİ ve DEKORATİF TELLER
- ❖ PLEXI - FOLYO - DEKOTE - POLYCARBON - KOMPOZİT VB.

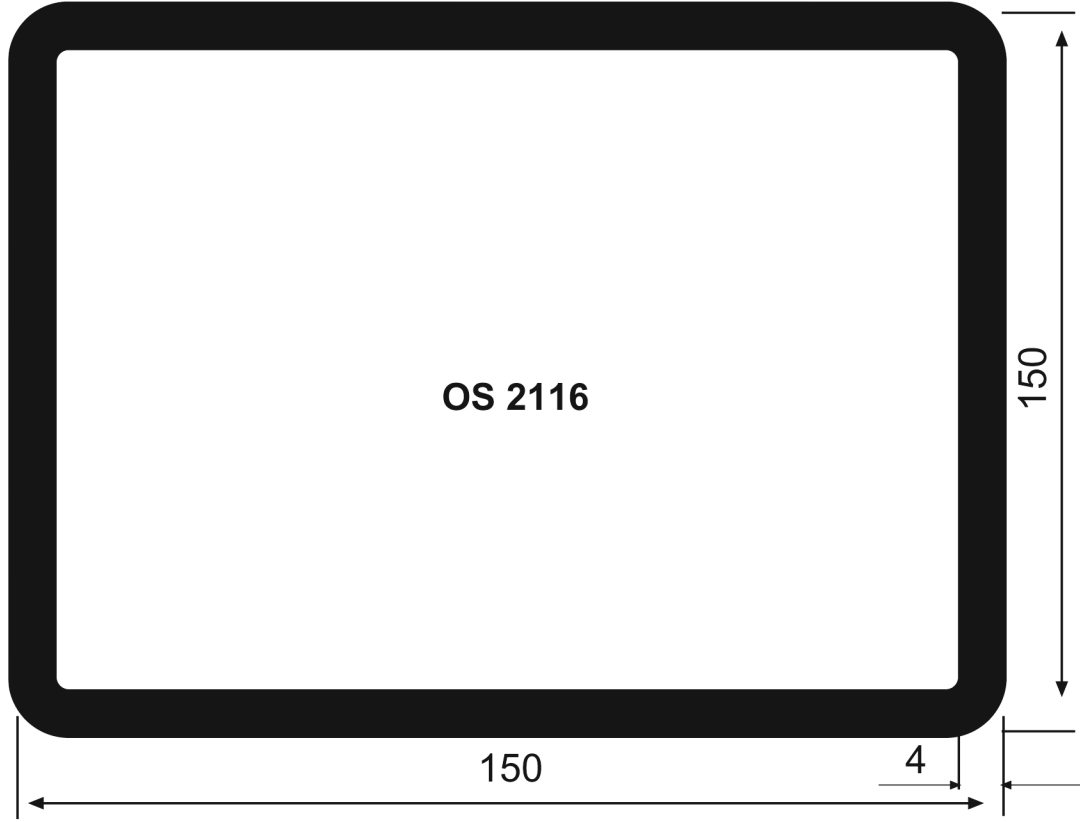



OSMANLI
ALÜMİNYUM SAN. ve TİC. LTD. ŞTİ.

- ❖ ÖZEL EBATLARDA BORU, KUTU, LAMA, KÖŞEBENT ÇEŞİTLERİ
- ❖ AYDINLATMA ve REKLAM PROFİLLERİ
- ❖ SOĞUTUCU ve LED PROFİLLERİ
- ❖ MOBİLYA ve SANAYİ PROFİLLERİ
- ❖ ÖZEL KALIP ÇİZİMLERİ ve İMALATI
- ❖ ELOKSALLI ve PRES PLAKA LEVHALARI
- ❖ GOFRAJLI ve DÜZ PARLAK RULO LEVHALARI
- ❖ LEVHA KESİM - BÜKÜM (ÖZEL ÖLÇÜLERİNİZDE)
- ❖ DELİKLİ ve DEKORATİF TELLER
- ❖ PLEXI - FOLYO - DEKOTE - POLYCARBON - KOMPOZİT VB.

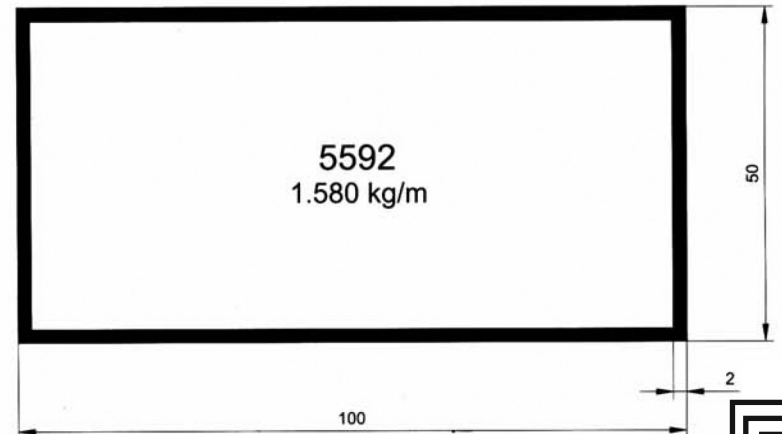
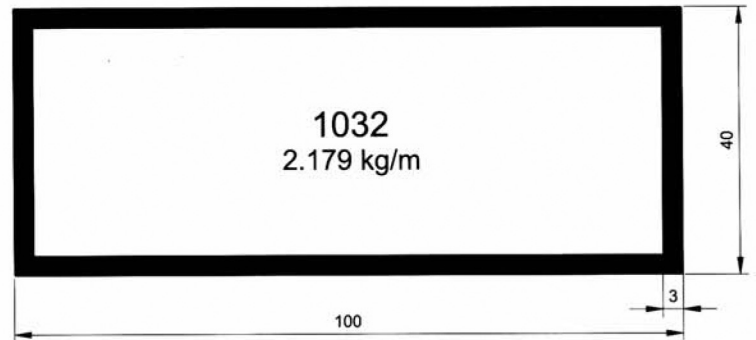
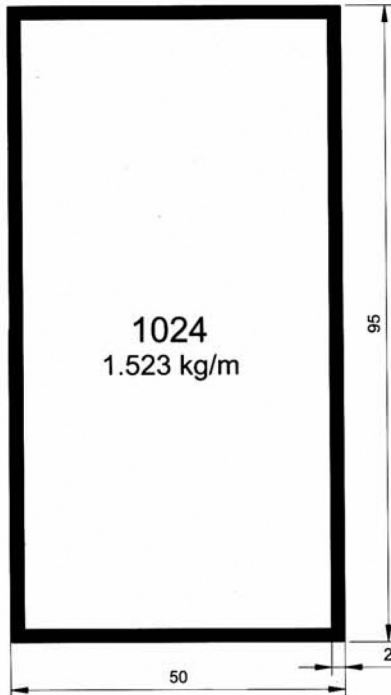
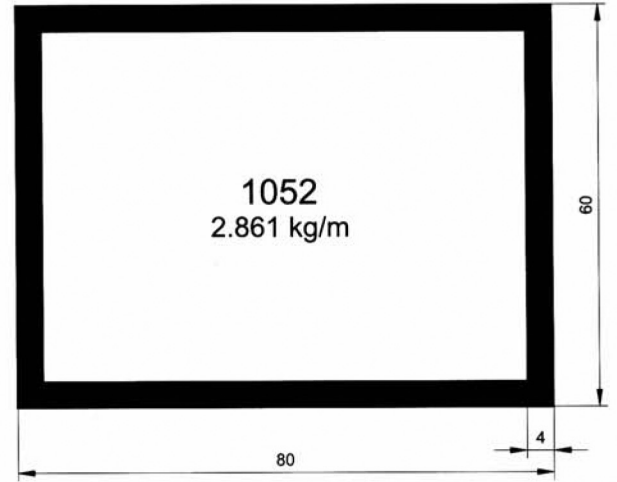
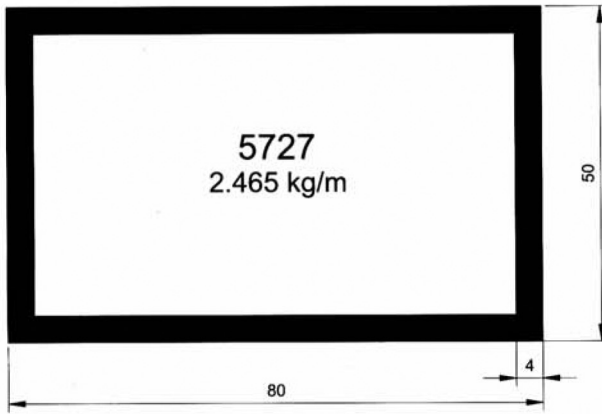
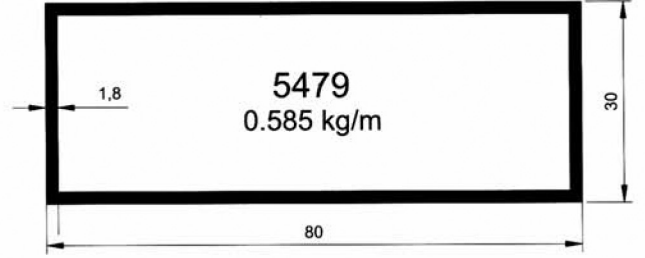
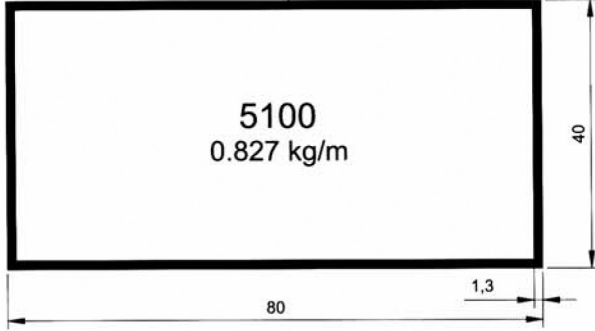



OSMANLI
ALÜMİNYUM SAN. ve TİC. LTD .ŞTİ.

- ❖ ÖZEL EBATLARDA BORU, KUTU, LAMA, KÖŞEBENT ÇEŞİTLERİ
- ❖ AYDINLATMA ve REKLAM PROFİLLERİ
- ❖ SOĞUTUCU ve LED PROFİLLERİ
- ❖ MOBİLYA ve SANAYİ PROFİLLERİ
- ❖ ÖZEL KALIP ÇİZİMLERİ ve İMALATI
- ❖ ELOKSALLI ve PRES PLAKA LEVHALARI
- ❖ GOFRAJLI ve DÜZ PARLAK RULO LEVHALARI
- ❖ LEVHA KESİM - BÜKÜM (ÖZEL ÖLÇÜLERİNİZDE)
- ❖ DELİKLİ ve DEKORATİF TELLER
- ❖ PLEXI - FOLYO - DEKOTE - POLYCARBON - KOMPOZİT VB.

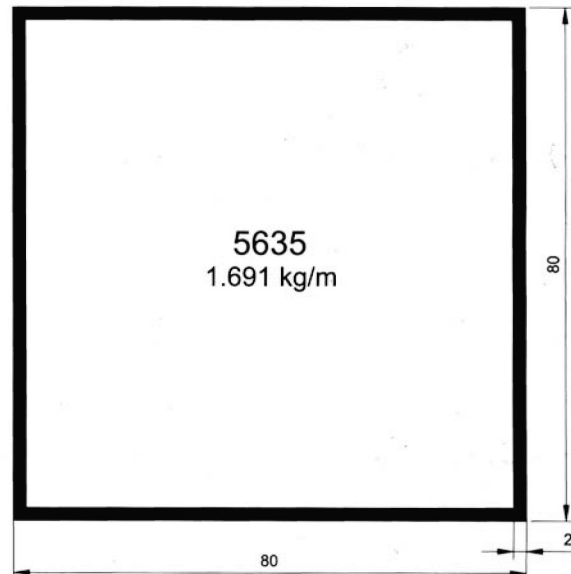
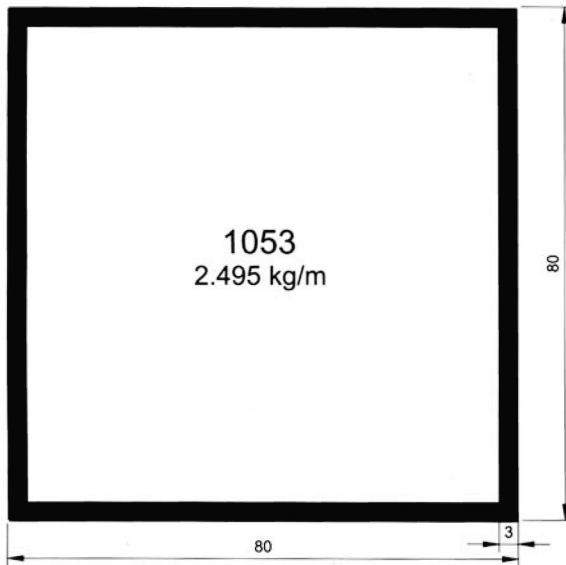
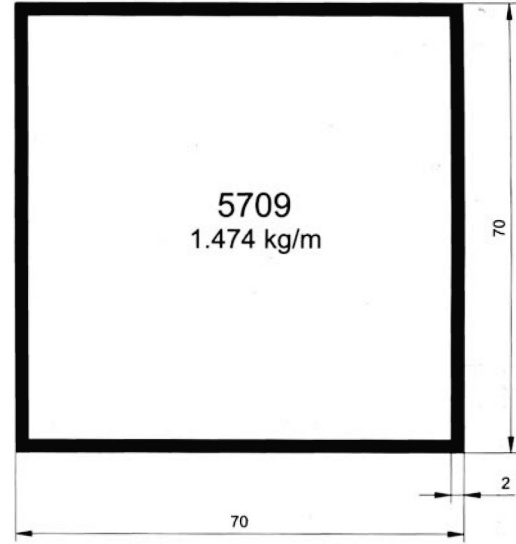
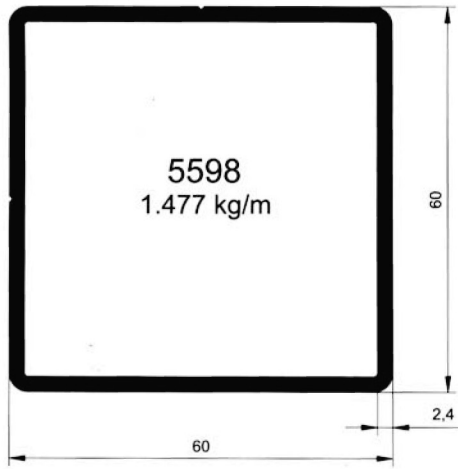
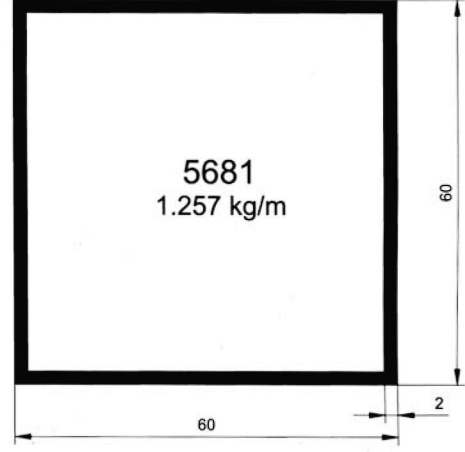
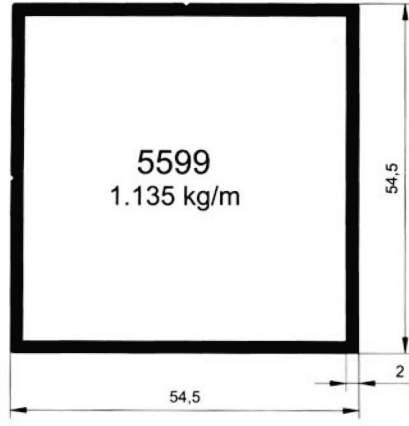



OSMANLI
ALÜMİNYUM SAN. ve TİC. LTD .ŞTİ.

- ❖ ÖZEL EBATLARDA BORU, KUTU, LAMA, KÖŞEBENT ÇEŞİTLERİ
- ❖ AYDINLATMA ve REKLAM PROFİLLERİ
- ❖ SOĞUTUCU ve LED PROFİLLERİ
- ❖ MOBİLYA ve SANAYİ PROFİLLERİ
- ❖ ÖZEL KALIP ÇİZİMLERİ ve İMALATI
- ❖ ELOKSALLI ve PRES PLAKA LEVHALARI
- ❖ GOFRAJLI ve DÜZ PARLAK RULO LEVHALARI
- ❖ LEVHA KESİM - BÜKÜM (ÖZEL ÖLÇÜLERİNİZDE)
- ❖ DELİKLİ ve DEKORATİF TELLER
- ❖ PLEXI - FOLYO - DEKOTE - POLYCARBON - KOMPOZİT VB.

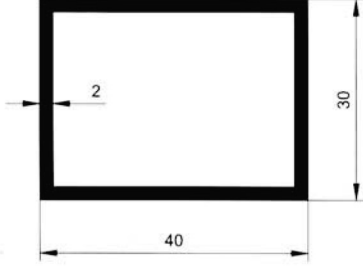

5720
0.715 kg/m

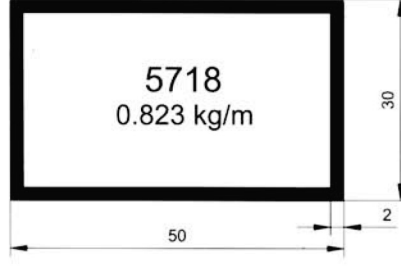

5718
0.823 kg/m

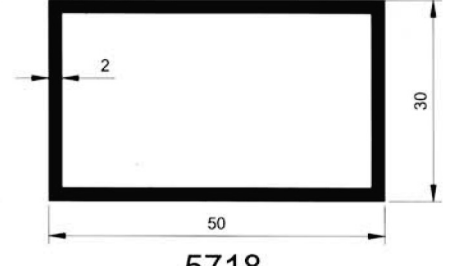

5718
0.823 kg/m

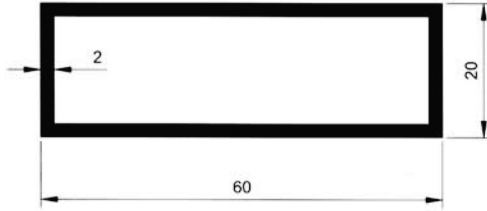

5484
0.821 kg/m

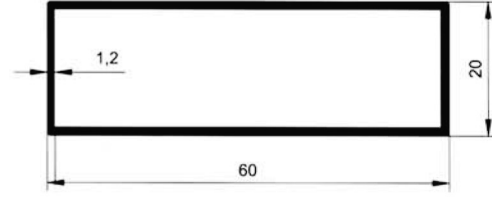

5587
0.500 kg/m

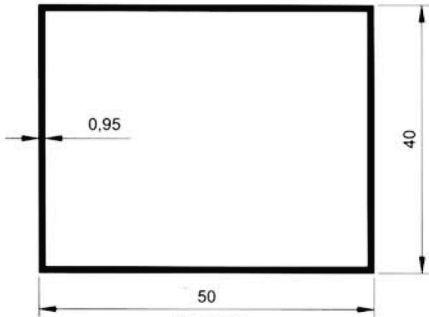

5103
0.453 kg/m

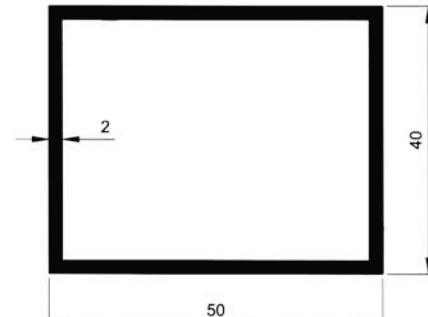

5488
0.932 kg/m

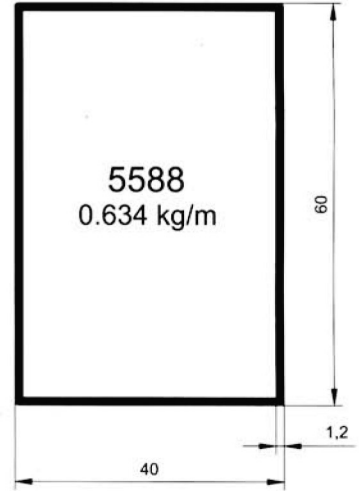

5588
0.634 kg/m

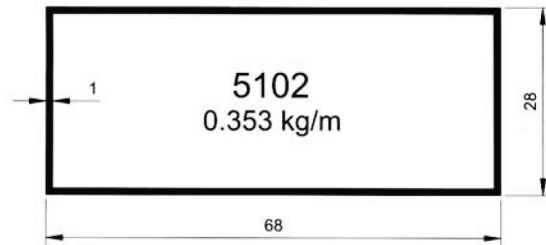

5102
0.353 kg/m

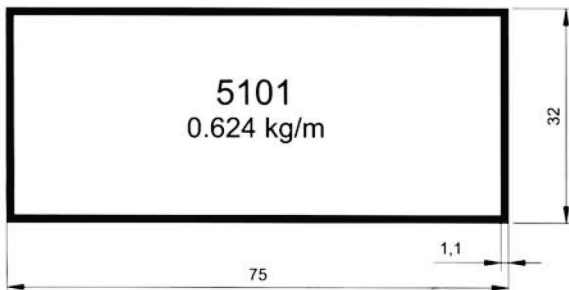

5101
0.624 kg/m

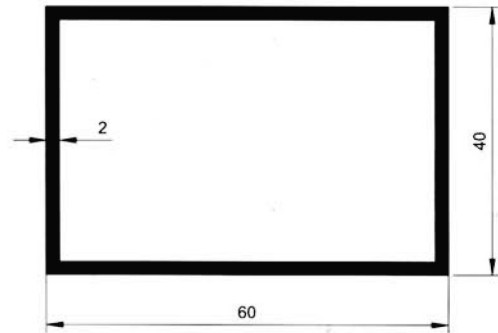

5489
1.038 kg/m



OSMANLI
ALÜMİNYUM SAN. ve TİC. LTD. ŞTİ.

- ❖ ÖZEL EBATLARDAN BORU, KUTU, LAMA, KÖŞEBENT ÇEŞİTLERİ
- ❖ AYDINLATMA ve REKLAM PROFİLLERİ
- ❖ SOĞUTUCU ve LED PROFİLLERİ
- ❖ MOBİLYA ve SANAYİ PROFİLLERİ
- ❖ ÖZEL KALIP ÇİZİMLERİ ve İMALATI
- ❖ ELOKSALLI ve PRES PLAKA LEVHALARI
- ❖ GOFRAJLI ve DÜZ PARLAK RULO LEVHALARI
- ❖ LEVHA KESİM - BÜKÜM (ÖZEL ÖLÇÜLERİNİZDE)
- ❖ DELİKLİ ve DEKORATİF TELLER
- ❖ PLEXI - FOLYO - DEKOTE - POLYCARBON - KOMPOZİT VB.

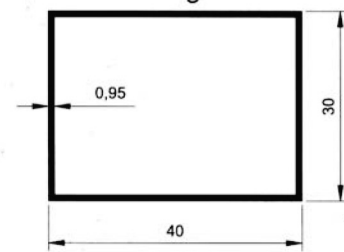
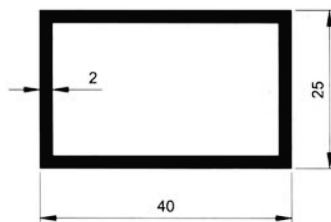
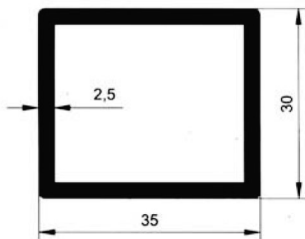
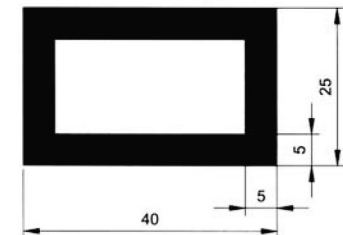
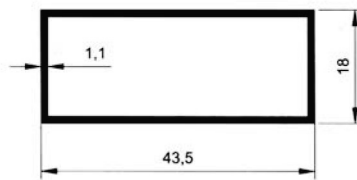
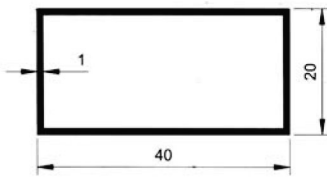
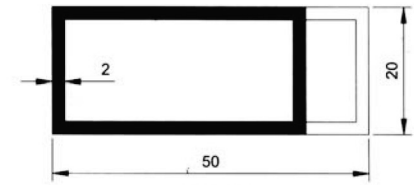
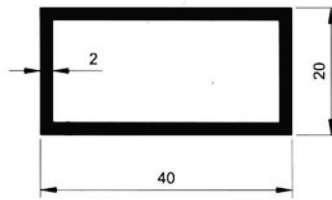
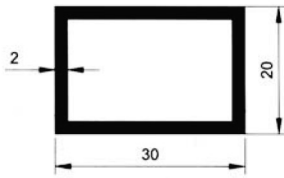
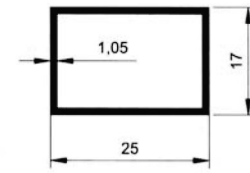
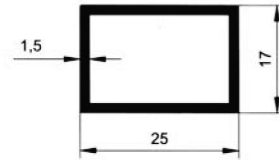
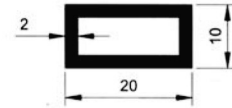
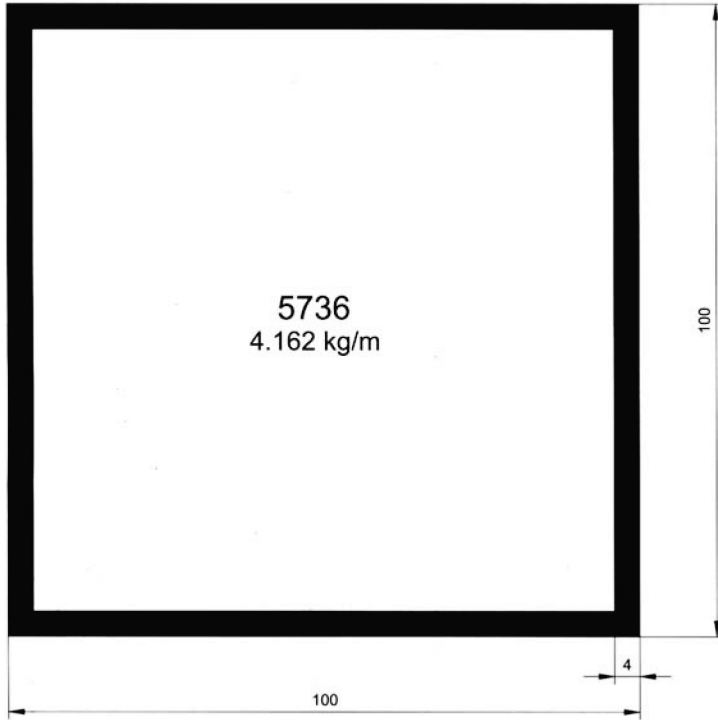



OSMANLI
ALÜMİNYUM SAN. ve TİC. LTD .ŞTİ.

- ❖ ÖZEL EBATLARDA BORU, KUTU, LAMA, KÖŞEBENT ÇEŞİTLERİ
- ❖ AYDINLATMA ve REKLAM PROFİLLERİ
- ❖ SOĞUTUCU ve LED PROFİLLERİ
- ❖ MOBİLYA ve SANAYİ PROFİLLERİ
- ❖ ÖZEL KALIP ÇİZİMLERİ ve İMALATI
- ❖ ELOKSALLI ve PRES PLAKA LEVHALARI
- ❖ GOFRAJLI ve DÜZ PARLAK RULO LEVHALARI
- ❖ LEVHA KESİM - BÜKÜM (ÖZEL ÖLÇÜLERİNİZDE)
- ❖ DELİKLİ ve DEKORATİF TELLER
- ❖ PLEXI - FOLYO - DEKOTE - POLYCARBON - KOMPOZİT VB.

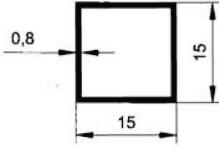

5604
0.122 kg/m

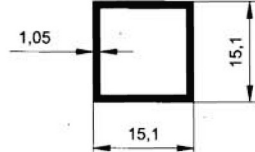

1037
0.160 kg/m

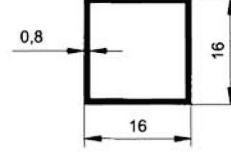

5732
0.132 kg/m

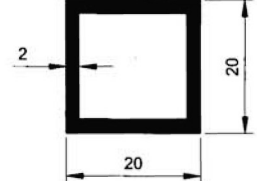

5481
0.390 kg/m

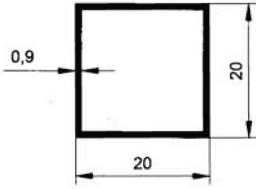

5603
0.185 kg/m

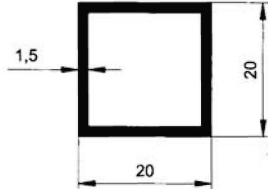

5786
0.301 kg/m

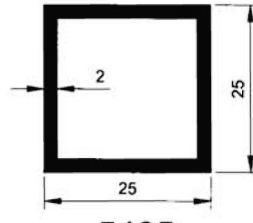

5485
0.499 kg/m

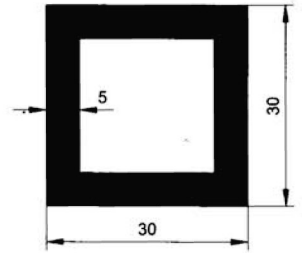

5705
1.355 kg/m

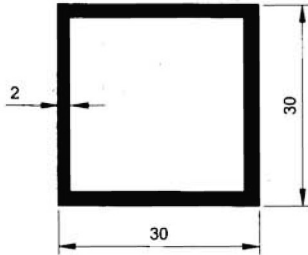

5486
0.607 kg/m

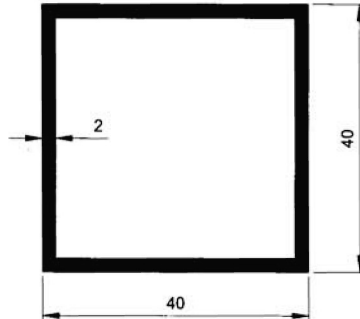

5487
0.821 kg/m

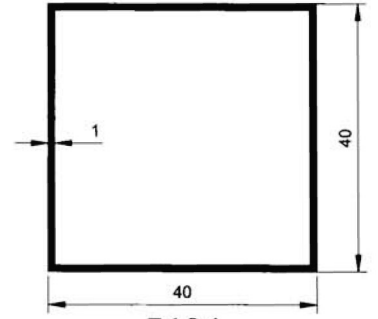

5104
0.422 kg/m

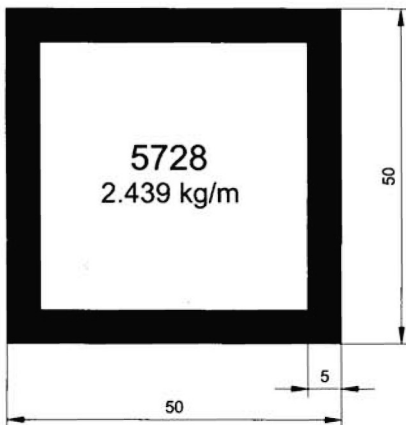

5728
2.439 kg/m

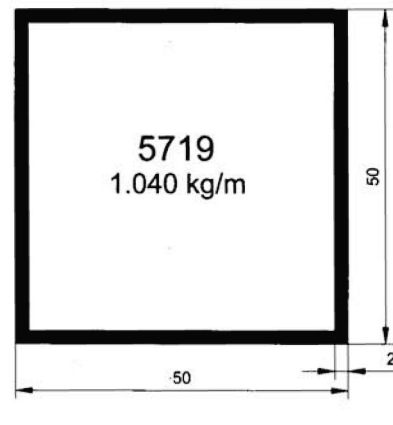

5719
1.040 kg/m

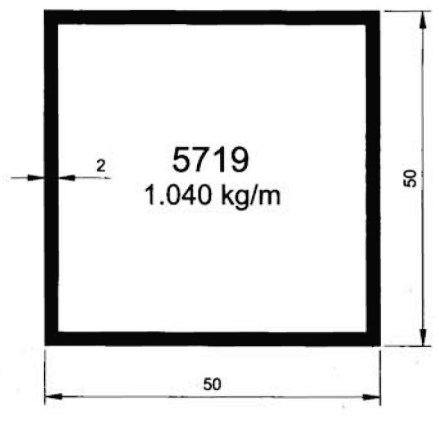

5719
1.040 kg/m



OSMANLI
ALÜMİNYUM SAN. ve TİC. LTD. ŞTİ.

- ❖ ÖZEL EBATLARDA BORU, KUTU, LAMA, KÖŞEBENT ÇEŞİTLERİ
- ❖ AYDINLATMA ve REKLAM PROFİLLERİ
- ❖ SOĞUTUCU ve LED PROFİLLERİ
- ❖ MOBİLYA ve SANAYİ PROFİLLERİ
- ❖ ÖZEL KALIP ÇİZİMLERİ ve İMALATI
- ❖ ELOKSALLI ve PRES PLAKA LEVHALARI
- ❖ GOFRAJLI ve DÜZ PARLAK RULO LEVHALARI
- ❖ LEVHA KESİM - BÜKÜM (ÖZEL ÖLÇÜLERİNİZDE)
- ❖ DELİKLİ ve DEKORATİF TELLER
- ❖ PLEXI - FOLYO - DEKOTE - POLYCARBON - KOMPOZİT VB.

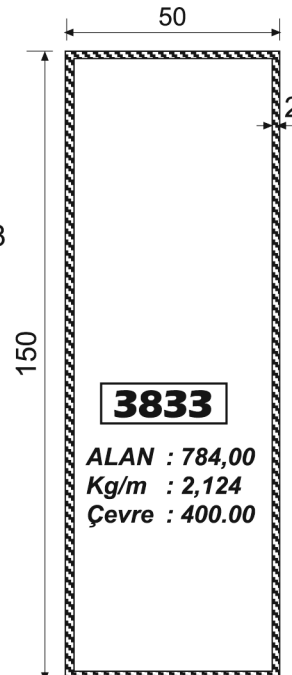
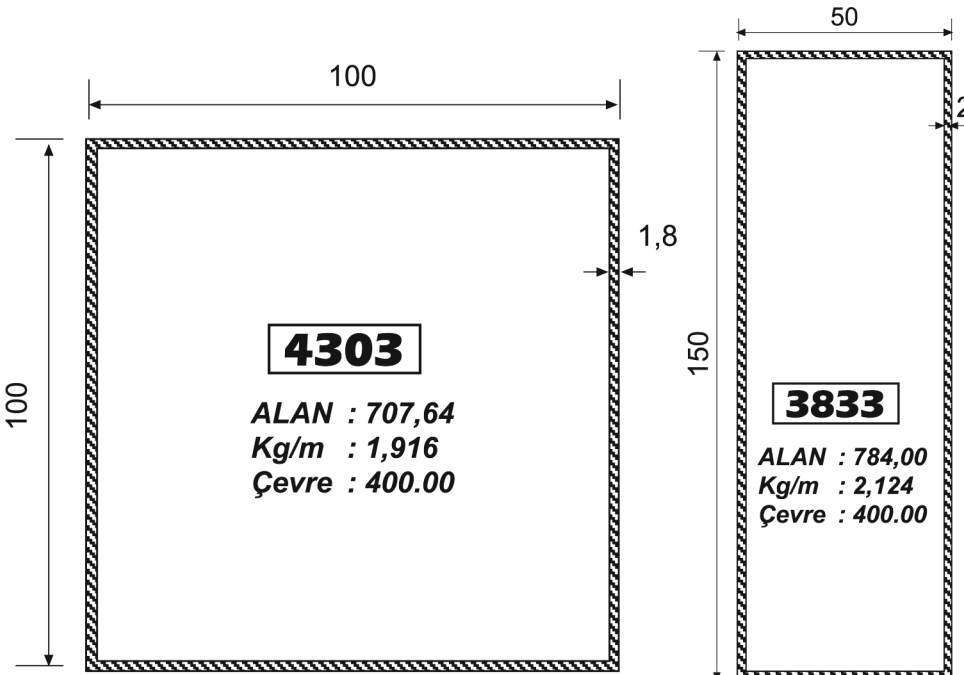
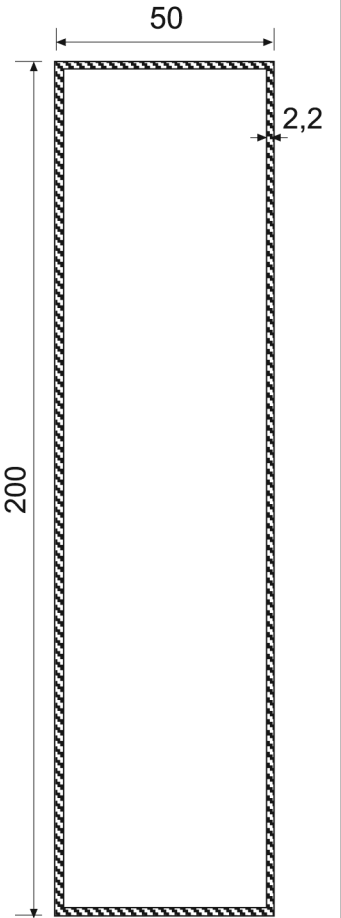
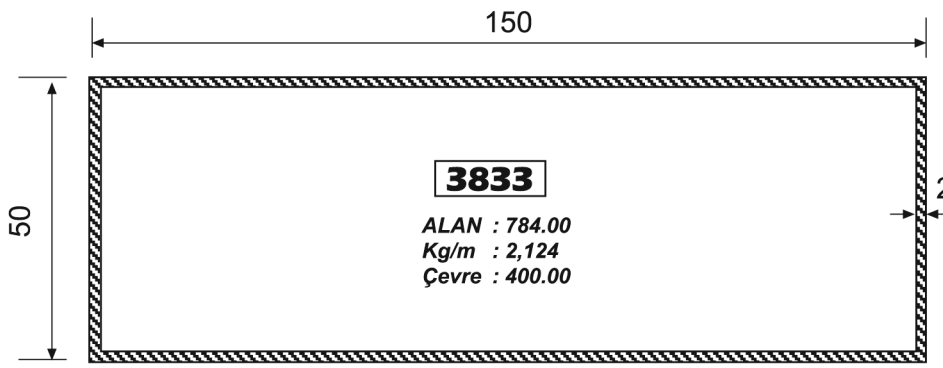
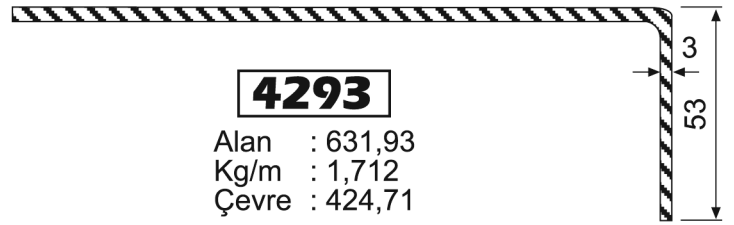
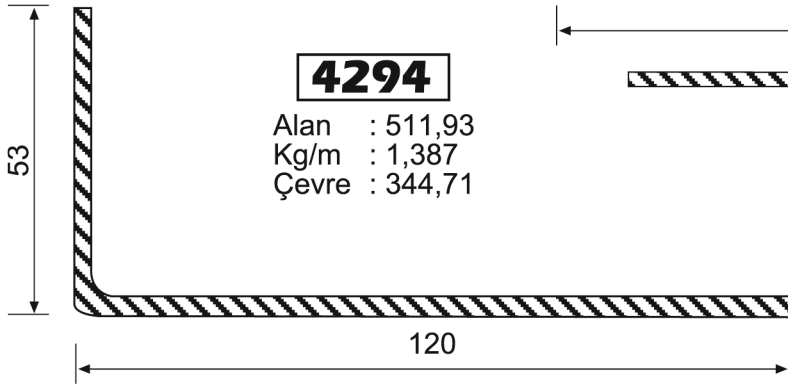
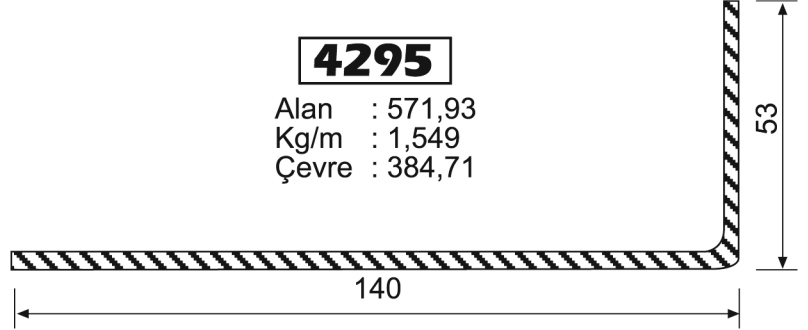
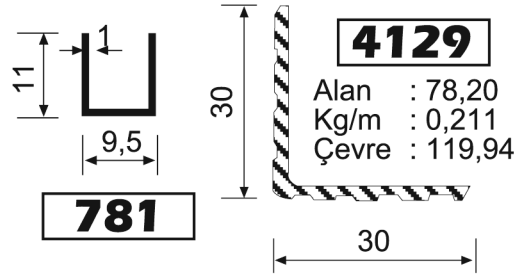



OSMANLI
ALÜMİNYUM SAN. ve TİC. LTD .ŞTİ.

- ❖ ÖZEL EBATLARDA BORU, KUTU, LAMA, KÖŞEBENT ÇEŞİTLERİ
- ❖ AYDINLATMA ve REKLAM PROFİLLERİ
- ❖ SOĞUTUCU ve LED PROFİLLERİ
- ❖ MOBİLYA ve SANAYİ PROFİLLERİ
- ❖ ÖZEL KALIP ÇİZİMLERİ ve İMALATI
- ❖ ELOKSALLI ve PRES PLAKA LEVHALARI
- ❖ GOFRAJLI ve DÜZ PARLAK RULO LEVHALARI
- ❖ LEVHA KESİM - BÜKÜM (ÖZEL ÖLÇÜLERİNİZDE)
- ❖ DELİKLİ ve DEKORATİF TELLER
- ❖ PLEXI - FOLYO - DEKOTE - POLYCARBON - KOMPOZİT VB.

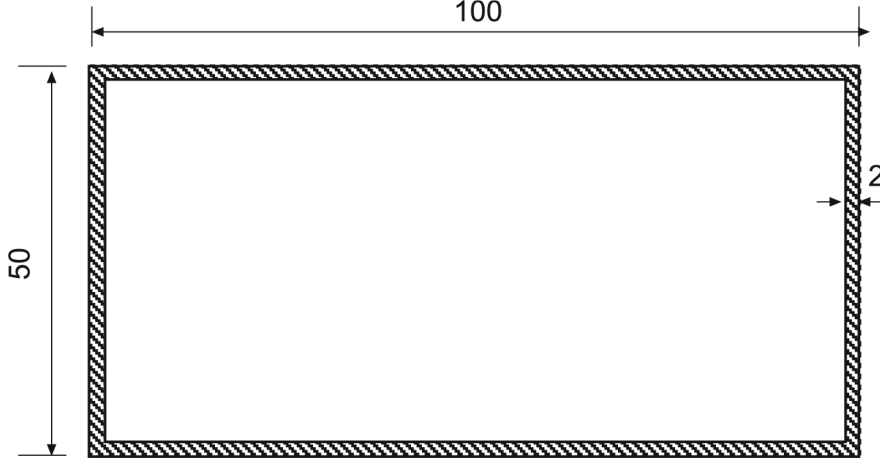

3832

ALAN : 584.00
Kg/m : 1.582
Çevre : 300.00

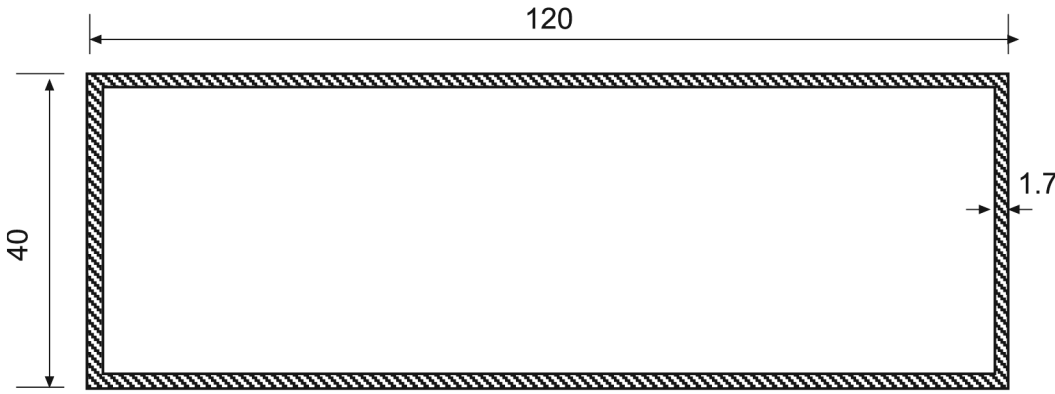

3410

ALAN : 527.28
Kg/m : 1.428
Çevre : 320.00

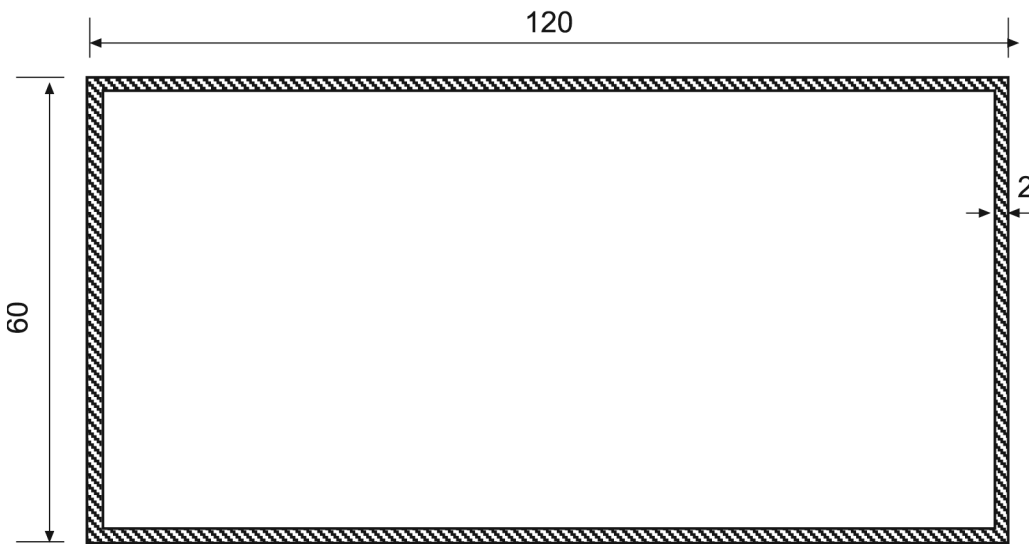

3831

ALAN : 704.00
Kg/m : 1.907
Çevre : 360.00



OSMANLI
ALÜMİNYUM SAN. ve TİC. LTD .ŞTİ.

- ❖ ÖZEL EBATLARDA BORU, KUTU, LAMA, KÖŞEBENT ÇEŞİTLERİ
- ❖ AYDINLATMA ve REKLAM PROFİLLERİ
- ❖ SOĞUTUCU ve LED PROFİLLERİ
- ❖ MOBİLYA ve SANAYİ PROFİLLERİ
- ❖ ÖZEL KALIP ÇİZİMLERİ ve İMALATI
- ❖ ELOKSALLI ve PRES PLAKA LEVHALARI
- ❖ GOFRAJLI ve DÜZ PARLAK RULO LEVHALARI
- ❖ LEVHA KESİM - BÜKÜM (ÖZEL ÖLÇÜLERİNİZDE)
- ❖ DELİKLİ ve DEKORATİF TELLER
- ❖ PLEXI - FOLYO - DEKOTE - POLYCARBON - KOMPOZİT VB.

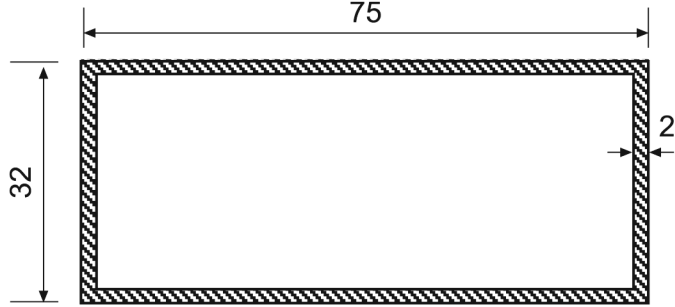

3065

ALAN : 412.00

Kg/m : 1.116

Çevre : 214.00

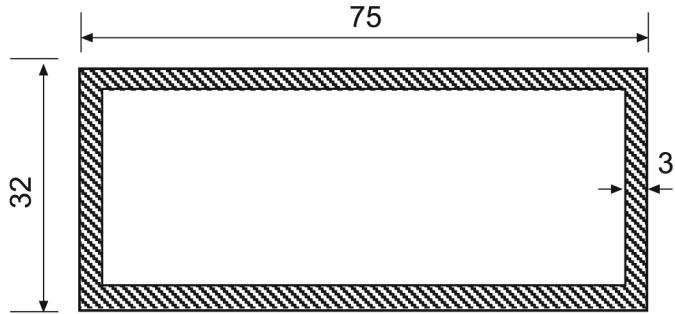

3891

ALAN : 606.00

Kg/m : 1.642

Çevre : 214.00

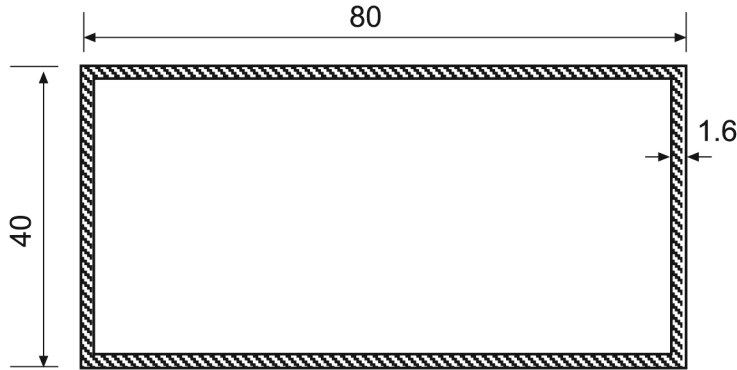

3414

ALAN : 370.16

Kg/m : 1.003

Çevre : 240.00

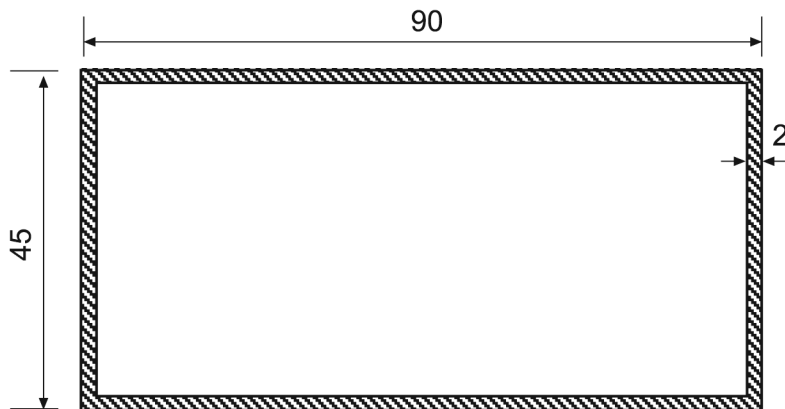

3580

ALAN : 524.00

Kg/m : 1.420

Çevre : 270.00



OSMANLI
ALÜMİNYUM SAN. ve TİC. LTD .ŞTİ.

- ❖ ÖZEL EBATLARDA BORU, KUTU, LAMA, KÖŞEBENT ÇEŞİTLERİ
- ❖ AYDINLATMA ve REKLAM PROFİLLERİ
- ❖ SOĞUTUCU ve LED PROFİLLERİ
- ❖ MOBİLYA ve SANAYİ PROFİLLERİ
- ❖ ÖZEL KALIP ÇİZİMLERİ ve İMALATI
- ❖ ELOKSALLI ve PRES PLAKA LEVHALARI
- ❖ GOFRAJLI ve DÜZ PARLAK RULO LEVHALARI
- ❖ LEVHA KESİM - BÜKÜM (ÖZEL ÖLÇÜLERİNİZDE)
- ❖ DELİKLİ ve DEKORATİF TELLER
- ❖ PLEXI - FOLYO - DEKOTE - POLYCARBON - KOMPOZİT VB.

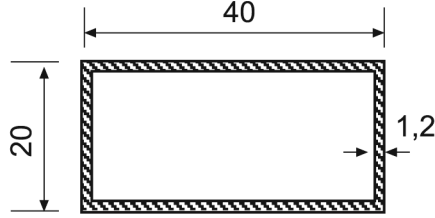

3017

ALAN : 188,09
Kg/m : 0,374
Çevre : 120,00

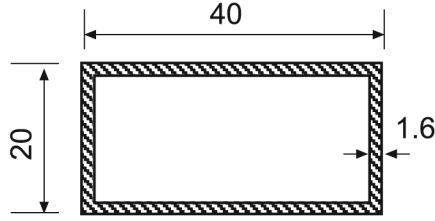

3017

ALAN : 181,76
Kg/m : 0,492
Çevre : 120,00

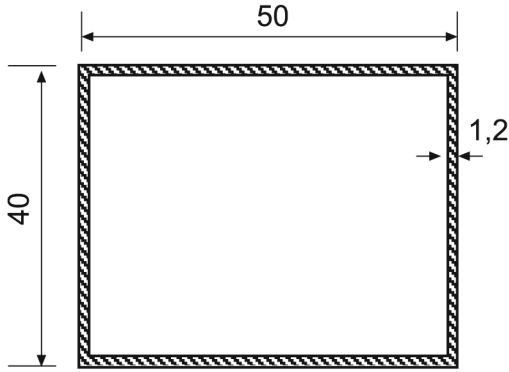

3015

ALAN : 206,59
Kg/m : 0,559
Çevre : 178,21

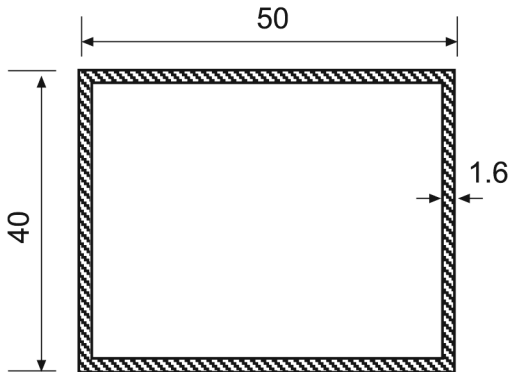

3015

ALAN : 277,76
Kg/m : 0,752
Çevre : 180,00

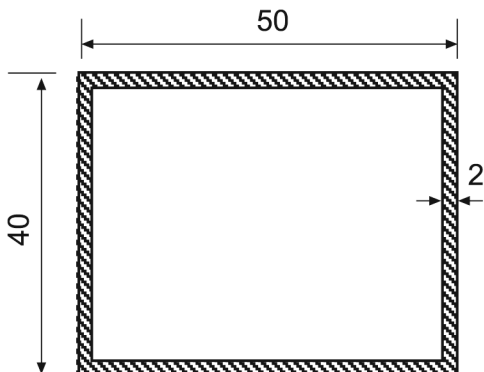

3015

ALAN : 344,00
Kg/m : 0,932
Çevre : 180,00



OSMANLI
ALÜMİNYUM SAN. ve TİC. LTD .ŞTİ.

- ❖ ÖZEL EBATLARDA BORU, KUTU, LAMA, KÖŞEBENT ÇEŞİTLERİ
- ❖ AYDINLATMA ve REKLAM PROFİLLERİ
- ❖ SOĞUTUCU ve LED PROFİLLERİ
- ❖ MOBİLYA ve SANAYİ PROFİLLERİ
- ❖ ÖZEL KALIP ÇİZİMLERİ ve İMALATI
- ❖ ELOKSALLI ve PRES PLAKA LEVHALARI
- ❖ GOFRAJLI ve DÜZ PARLAK RULO LEVHALARI
- ❖ LEVHA KESİM - BÜKÜM (ÖZEL ÖLÇÜLERİNİZDE)
- ❖ DELİKLİ ve DEKORATİF TELLER
- ❖ PLEXI - FOLYO - DEKOTE - POLYCARBON - KOMPOZİT VB.

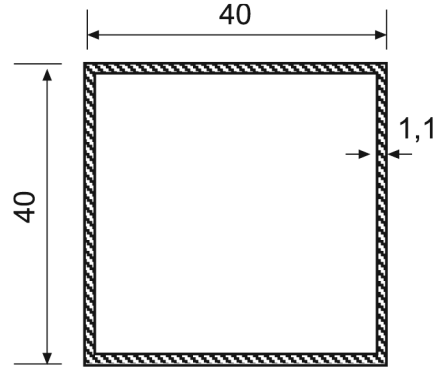

3019

ALAN : 169,51
Kg/m : 0,459
Çevre : 160,00

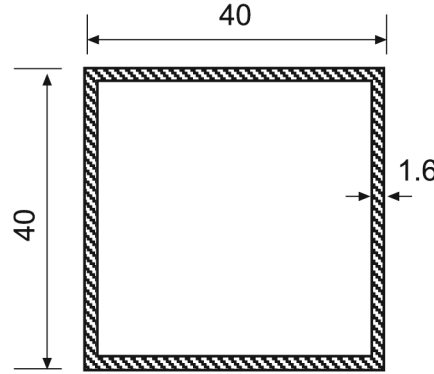

3019

ALAN : 245,76
Kg/m : 0,666
Çevre : 160,00

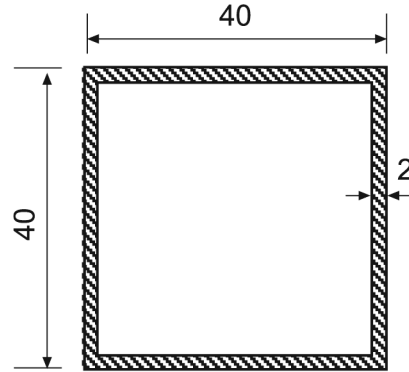

3019

ALAN : 245,76
Kg/m : 0,666
Çevre : 160,00

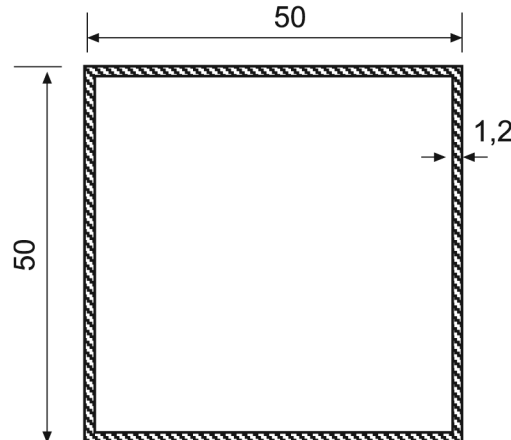

3893

ALAN : 120,89
Kg/m : 0,327
Çevre : 174,52



OSMANLI
ALÜMİNYUM SAN. ve TİC. LTD .ŞTİ.

- ❖ ÖZEL EBATLARDA BORU, KUTU, LAMA, KÖŞEBENT ÇEŞİTLERİ
- ❖ AYDINLATMA ve REKLAM PROFİLLERİ
- ❖ SOĞUTUCU ve LED PROFİLLERİ
- ❖ MOBİLYA ve SANAYİ PROFİLLERİ
- ❖ ÖZEL KALIP ÇİZİMLERİ ve İMALATI
- ❖ ELOKSALLI ve PRES PLAKA LEVHALARI
- ❖ GOFRAJLI ve DÜZ PARLAK RULO LEVHALARI
- ❖ LEVHA KESİM - BÜKÜM (ÖZEL ÖLÇÜLERİNİZDE)
- ❖ DELİKLİ ve DEKORATİF TELLER
- ❖ PLEXI - FOLYO - DEKOTE - POLYCARBON - KOMPOZİT VB.

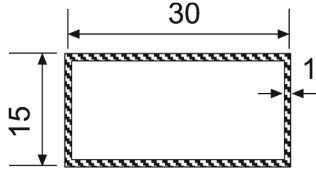

4019

ALAN : 86.00
Kg/m : 0.233
Çevre : 90.00

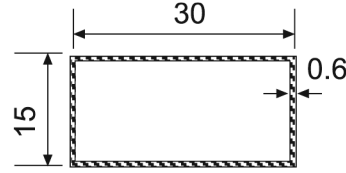

4051

ALAN : 52.56
Kg/m : 0.149
Çevre : 90.00

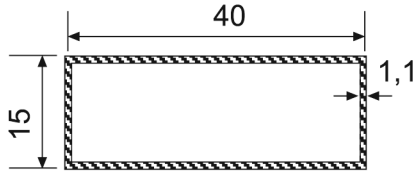

1475

ALAN : 117.37
Kg/m : 0.318
Çevre : 111.10

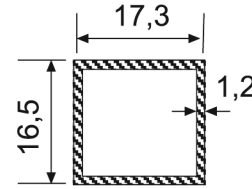

1476

ALAN : 75,36
Kg/m : 0.204
Çevre : 67.60

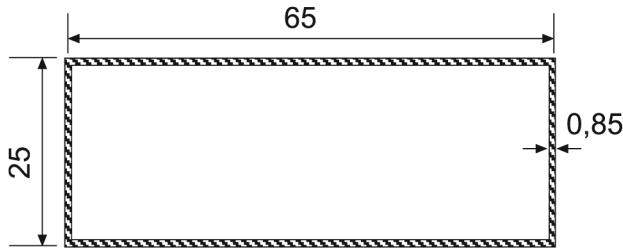

1478

ALAN : 150.11
Kg/m : 0.406
Çevre : 180.00

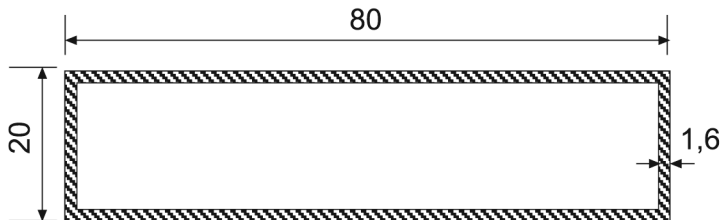

4274

ALAN : 309,68
Kg/m : 0.839
Çevre : 199.48



OSMANLI
ALÜMİNYUM SAN. ve TİC. LTD .ŞTİ.

- ❖ ÖZEL EBATLARDA BORU, KUTU, LAMA, KÖŞEBENT ÇEŞİTLERİ
- ❖ AYDINLATMA ve REKLAM PROFİLLERİ
- ❖ SOĞUTUCU ve LED PROFİLLERİ
- ❖ MOBİLYA ve SANAYİ PROFİLLERİ
- ❖ ÖZEL KALIP ÇİZİMLERİ ve İMALATI
- ❖ ELOKSALLI ve PRES PLAKA LEVHALARI
- ❖ GOFRAJLI ve DÜZ PARLAK RULO LEVHALARI
- ❖ LEVHA KESİM - BÜKÜM (ÖZEL ÖLÇÜLERİNİZDE)
- ❖ DELİKLİ ve DEKORATİF TELLER
- ❖ PLEXI - FOLYO - DEKOTE - POLYCARBON - KOMPOZİT VB.

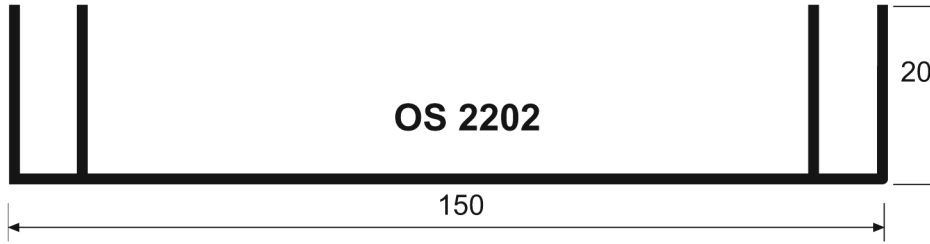
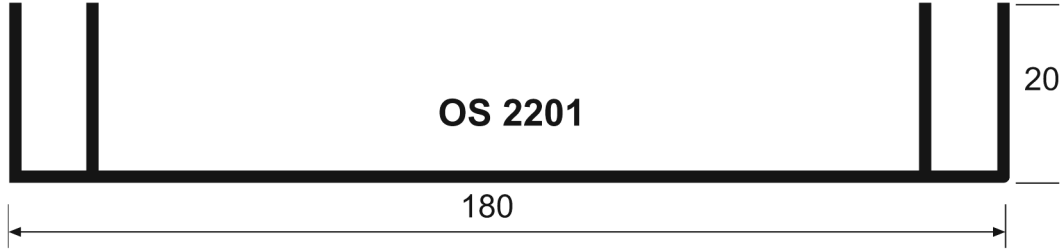
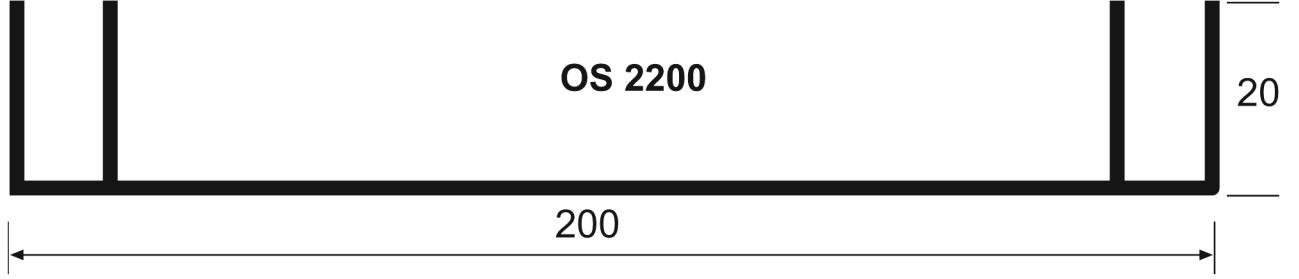



OSMANLI
ALÜMİNYUM SAN. ve TİC. LTD .ŞTİ.

- ❖ ÖZEL EBATLARDA BORU, KUTU, LAMA, KÖŞEBENT ÇEŞİTLERİ
- ❖ AYDINLATMA ve REKLAM PROFİLLERİ
- ❖ SOĞUTUCU ve LED PROFİLLERİ
- ❖ MOBİLYA ve SANAYİ PROFİLLERİ
- ❖ ÖZEL KALIP ÇİZİMLERİ ve İMALATI
- ❖ ELOKSALLI ve PRES PLAKA LEVHALARI
- ❖ GOFRAJLI ve DÜZ PARLAK RULO LEVHALARI
- ❖ LEVHA KESİM - BÜKÜM (ÖZEL ÖLÇÜLERİNİZDE)
- ❖ DELİKLİ ve DEKORATİF TELLER
- ❖ PLEXI - FOLYO - DEKOTE - POLYCARBON - KOMPOZİT VB.

REKLAM PANO PROFİLLERİ (1)

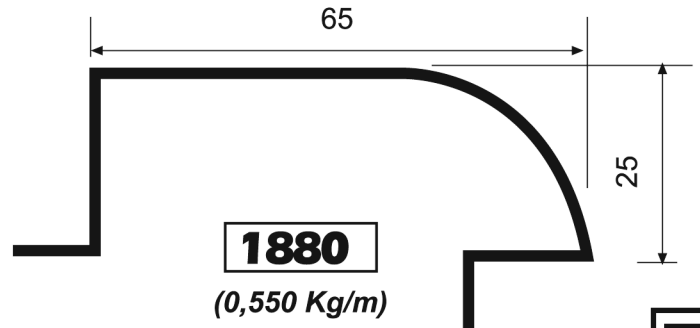
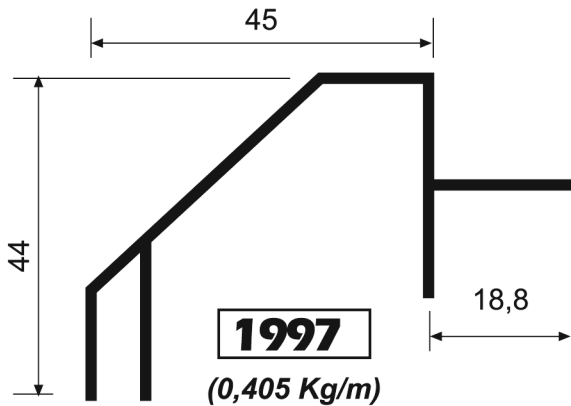
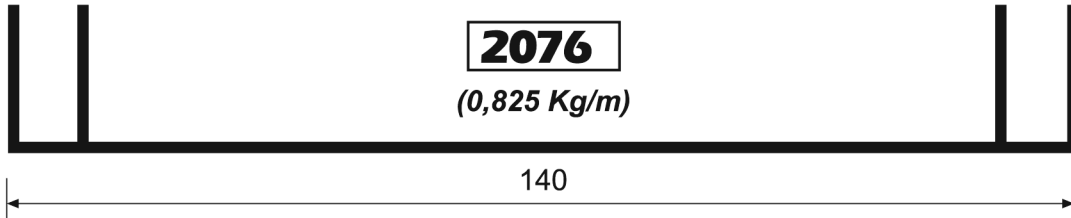
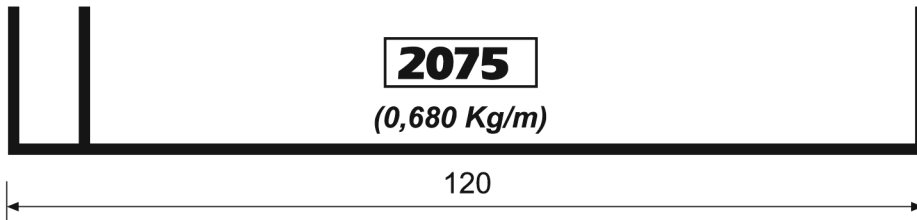
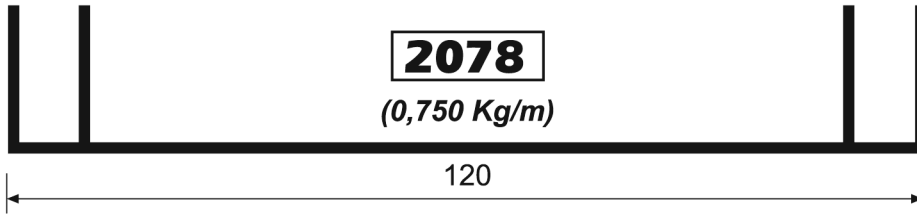
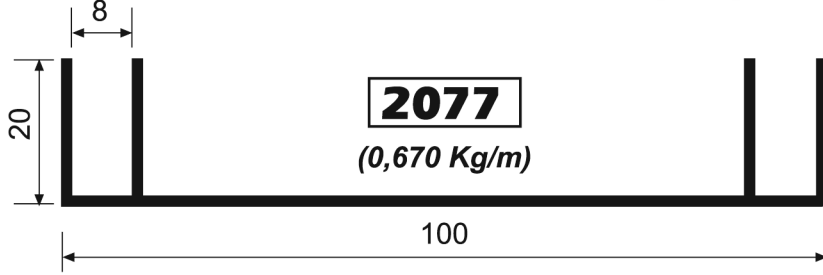



OSMANLI
ALÜMİNYUM SAN. ve TİC. LTD. ŞTİ.

- ❖ ÖZEL EBATLARDA BORU, KUTU, LAMA, KÖŞEBENT ÇEŞİTLERİ
- ❖ AYDINLATMA ve REKLAM PROFİLLERİ
- ❖ SOĞUTUCU ve LED PROFİLLERİ
- ❖ MOBİLYA ve SANAYİ PROFİLLERİ
- ❖ ÖZEL KALIP ÇİZİMLERİ ve İMALATI
- ❖ ELOKSALLI ve PRES PLAKA LEVHALARI
- ❖ GOFRAJLI ve DÜZ PARLAK RULO LEVHALARI
- ❖ LEVHA KESİM - BÜKÜM (ÖZEL ÖLÇÜLERİNİZDE)
- ❖ DELİKLİ ve DEKORATİF TELLER
- ❖ PLEXI - FOLYO - DEKOTE - POLYCARBON - KOMPOZİT VB.

REKLAM PANO PROFİLLERİ (2)

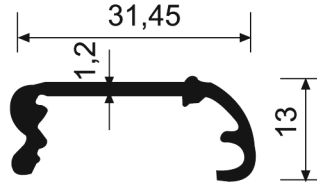

5275

(0,216 Kg/m)

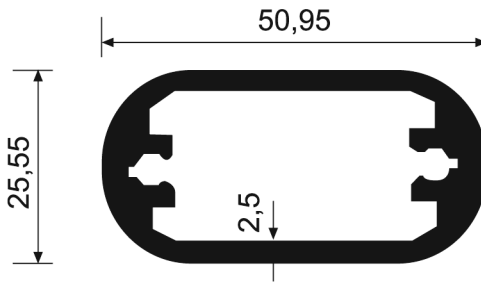

5276

(1,126 Kg/m)

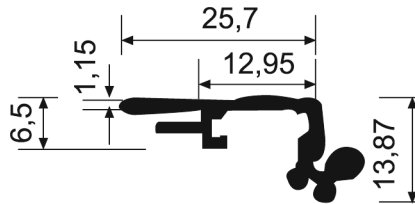

5277

(0,227 Kg/m)

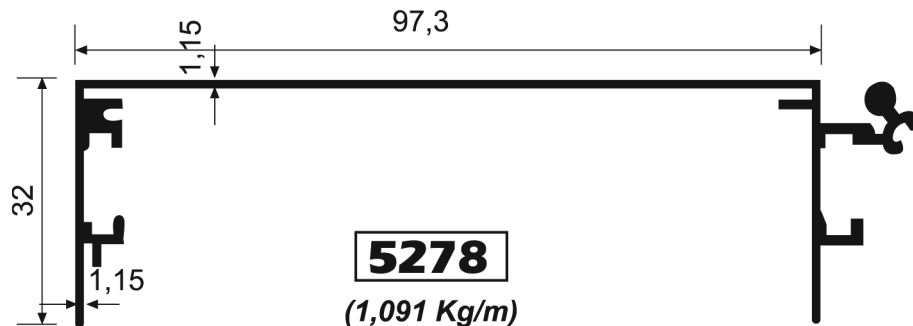

5278

(1,091 Kg/m)



OSMANLI
ALÜMİNYUM SAN. ve TİC. LTD .ŞTİ.

- ❖ ÖZEL EBATLARDA BORU, KUTU, LAMA, KÖŞEBENT ÇEŞİTLERİ
- ❖ AYDINLATMA ve REKLAM PROFİLLERİ
- ❖ SOĞUTUCU ve LED PROFİLLERİ
- ❖ MOBİLYA ve SANAYİ PROFİLLERİ
- ❖ ÖZEL KALIP ÇİZİMLERİ ve İMALATI
- ❖ ELOKSALLI ve PRES PLAKA LEVHALARI
- ❖ GOFRAJLI ve DÜZ PARLAK RULO LEVHALARI
- ❖ LEVHA KESİM - BÜKÜM (ÖZEL ÖLÇÜLERİNİZDE)
- ❖ DELİKLİ ve DEKORATİF TELLER
- ❖ PLEXI - FOLYO - DEKOTE - POLYCARBON - KOMPOZİT VB.

REKLAM PROFİLLERİ

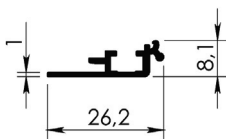
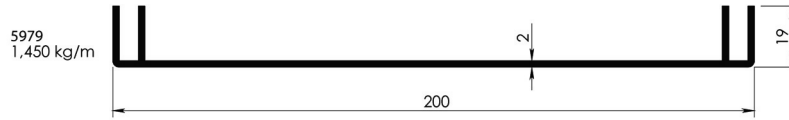
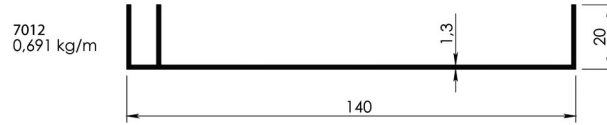
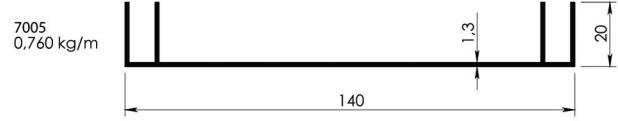
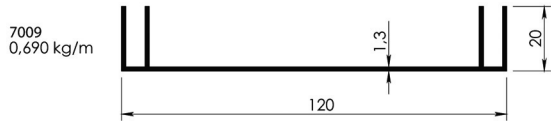
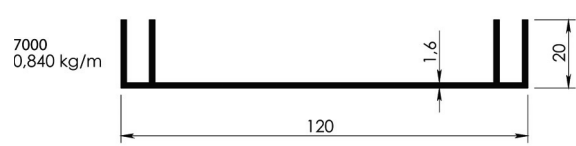

4423 - 0,131 kg/m

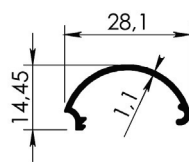

4424 - 0,133 kg/m

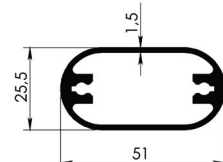

4869 - 0,813 kg/m

RAF STAND PROFİLLERİ

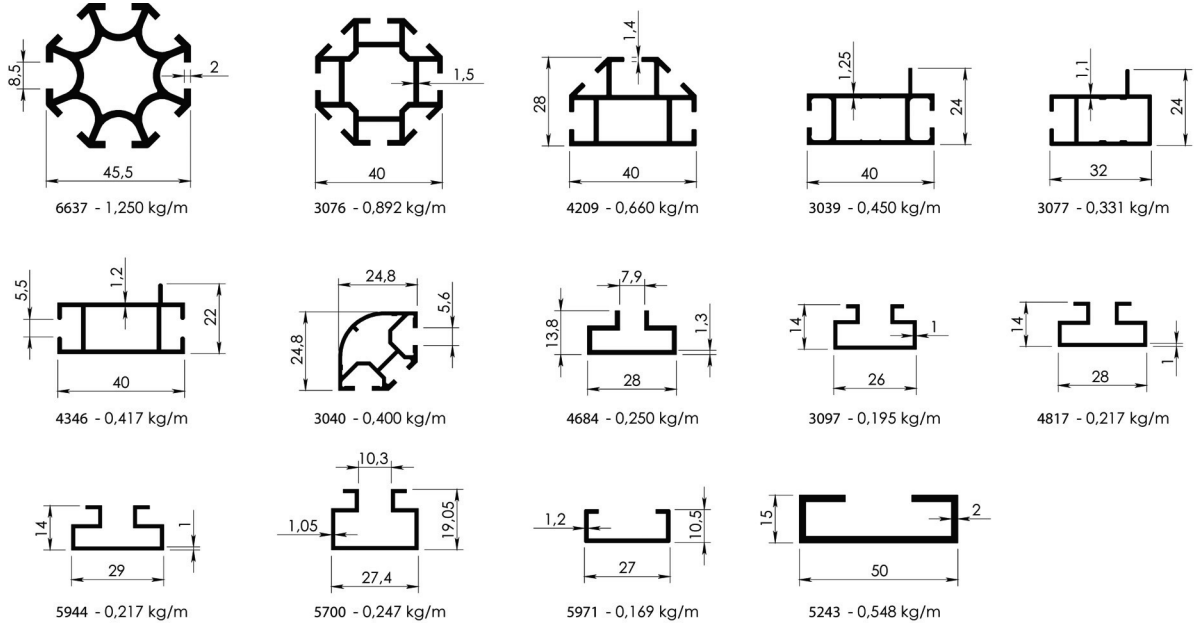

RAF DİKME PROFİLLERİ

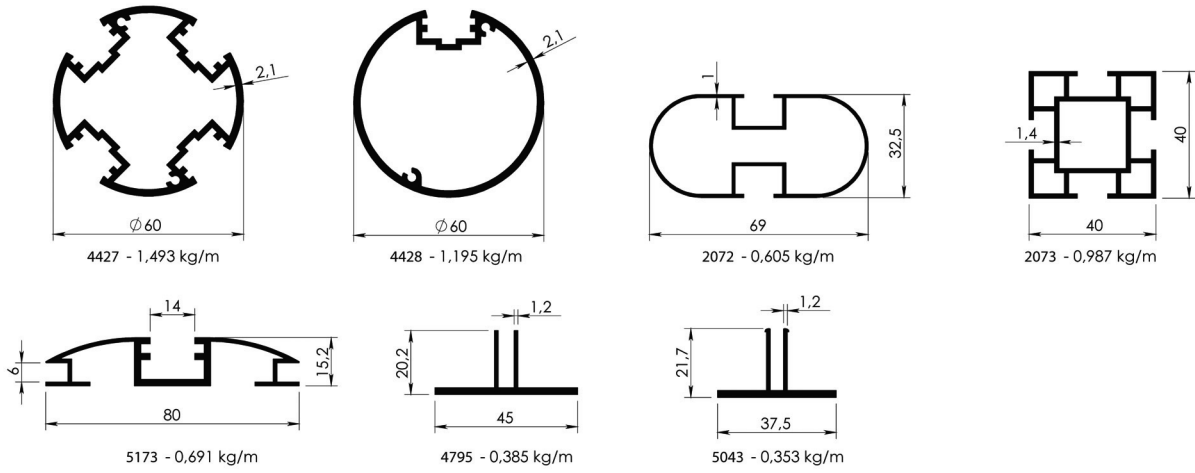

HAVALANDIRMA KABİN PROFİLLERİ

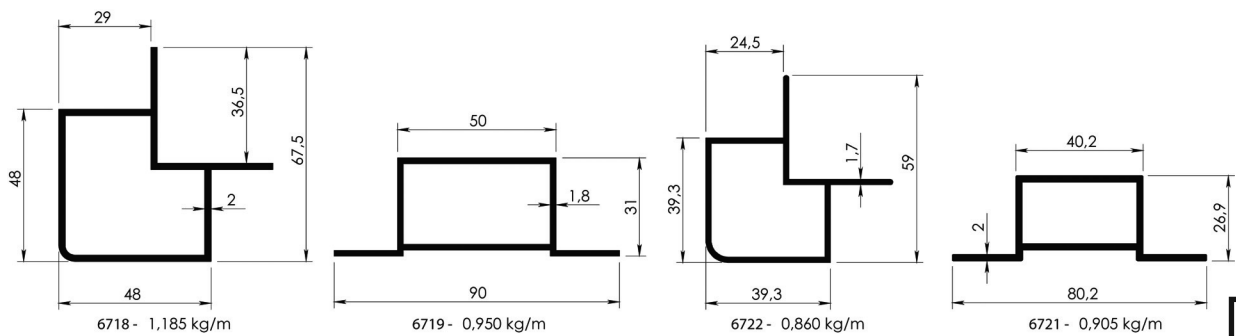



OSMANLI
ALÜMİNYUM SAN. ve TİC. LTD. ŞTİ.

- ❖ ÖZEL EBATLARDA BORU, KUTU, LAMA, KÖŞEBENT ÇEŞİTLERİ
- ❖ AYDINLATMA ve REKLAM PROFİLLERİ
- ❖ SOĞUTUCU ve LED PROFİLLERİ
- ❖ MOBİLYA ve SANAYİ PROFİLLERİ
- ❖ ÖZEL KALIP ÇİZİMLERİ ve İMALATI
- ❖ ELOKSALLI ve PRES PLAKA LEVHALARI
- ❖ GOFRAJLI ve DÜZ PARLAK RULO LEVHALARI
- ❖ LEVHA KESİM - BÜKÜM (ÖZEL ÖLÇÜLERİNİZDE)
- ❖ DELİKLİ ve DEKORATİF TELLER
- ❖ PLEXI - FOLYO - DEKOTE - POLYCARBON - KOMPOZİT VB.

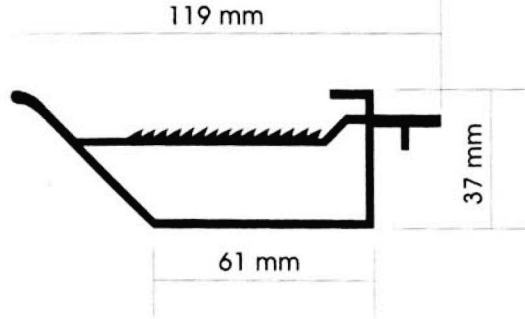

KALIP NO : 203
AĞIRLIK : 1.642 Kg/m

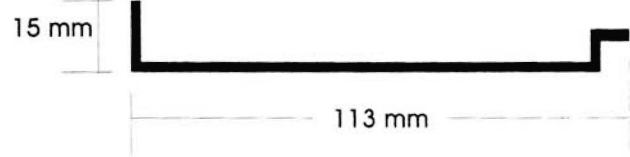

KALIP NO : 204
AĞIRLIK : 0.682 Kg/m

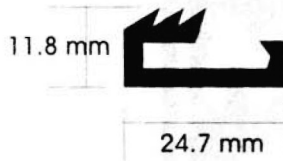

KALIP NO : 205
AĞIRLIK : 0.343 Kg/m

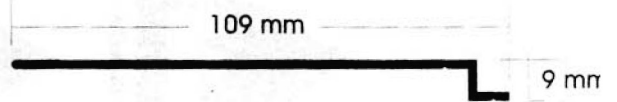

KALIP NO : 206
AĞIRLIK : 0.610 Kg/m

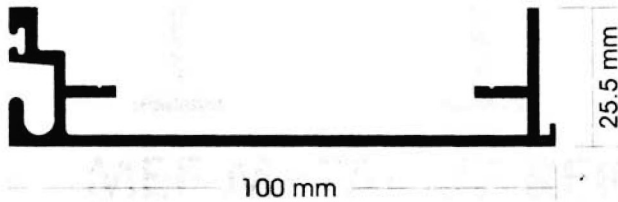

KALIP NO : 110
AĞIRLIK : 1.045 Kg/m



KALIP NO : 107
AĞIRLIK : 0.628 Kg/m

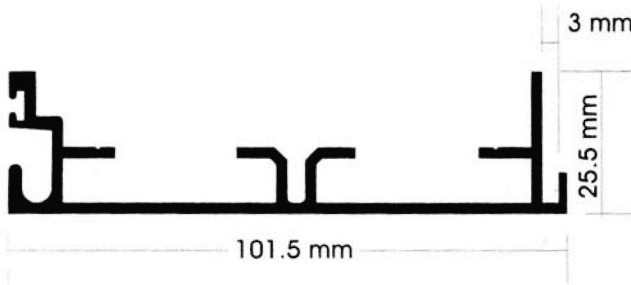

KALIP NO : 114
AĞIRLIK : 1.198 Kg/m



KALIP NO : 2006
AĞIRLIK : 0.485 Kg/m



OSMANLI
ALÜMİNYUM SAN. ve TİC. LTD. ŞTİ.

- ❖ ÖZEL EBATLARDA BORU, KUTU, LAMA, KÖŞEBENT ÇEŞİTLERİ
- ❖ AYDINLATMA ve REKLAM PROFİLLERİ
- ❖ SOĞUTUCU ve LED PROFİLLERİ
- ❖ MOBİLYA ve SANAYİ PROFİLLERİ
- ❖ ÖZEL KALIP ÇİZİMLERİ ve İMALATI
- ❖ ELOKSALLI ve PRES PLAKA LEVHALARI
- ❖ GOFRAJLI ve DÜZ PARLAK RULO LEVHALARI
- ❖ LEVHA KESİM - BÜKÜM (ÖZEL ÖLÇÜLERİNİZDE)
- ❖ DELİKLİ ve DEKORATİF TELLER
- ❖ PLEXI - FOLYO - DEKOTE - POLYCARBON - KOMPOZİT VB.

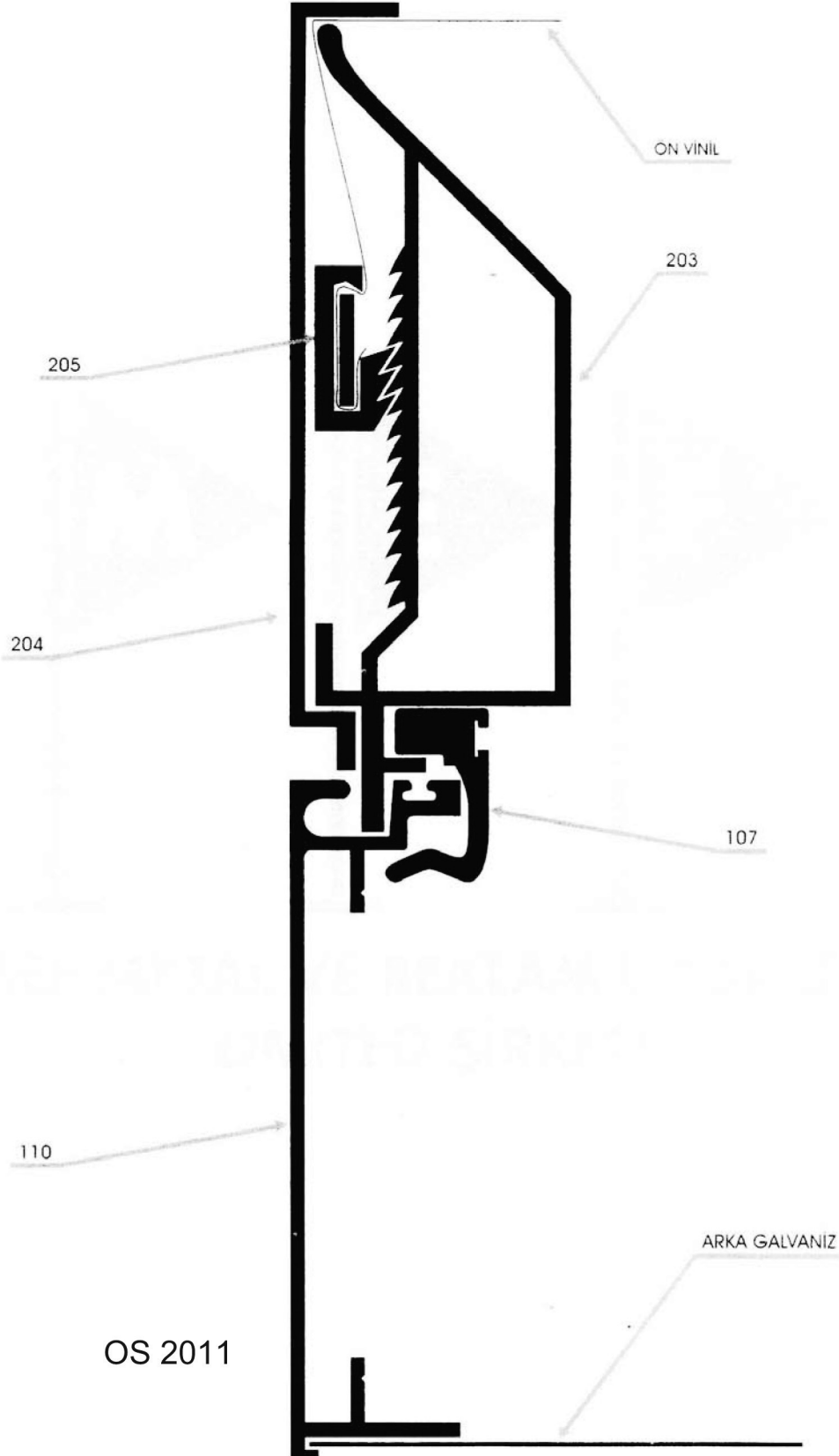



OSMANLI
ALÜMİNYUM SAN. ve TİC. LTD .ŞTİ.

- ❖ ÖZEL EBATLARDA BORU, KUTU, LAMA, KÖŞEBENT ÇEŞİTLERİ
- ❖ AYDINLATMA ve REKLAM PROFİLLERİ
- ❖ SOĞUTUCU ve LED PROFİLLERİ
- ❖ MOBİLYA ve SANAYİ PROFİLLERİ
- ❖ ÖZEL KALIP ÇİZİMLERİ ve İMALATI
- ❖ ELOKSALLI ve PRES PLAKA LEVHALARI
- ❖ GOFRAJLI ve DÜZ PARLAK RULO LEVHALARI
- ❖ LEVHA KESİM - BÜKÜM (ÖZEL ÖLÇÜLERİNİZDE)
- ❖ DELİKLİ ve DEKORATİF TELLER
- ❖ PLEXI - FOLYO - DEKOTE - POLYCARBON - KOMPOZİT VB.

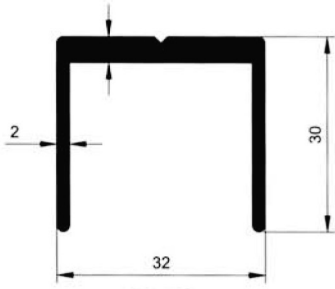

5074
0.622 kg/m

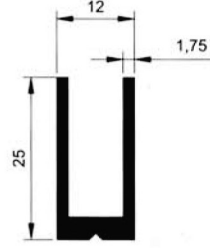

5076
0.315 kg/m

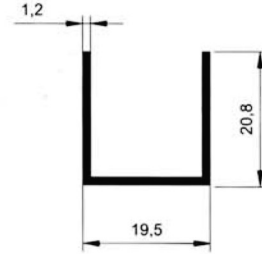

5090
0.189 kg/m

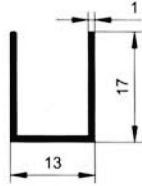

5120
0.122 kg/m

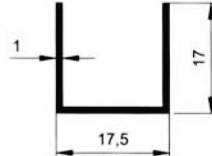

5121
0.134 kg/m

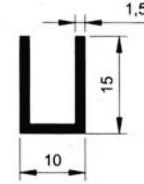

5389
0.151 kg/m

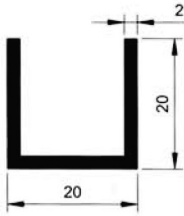

5402
0.303 kg/m

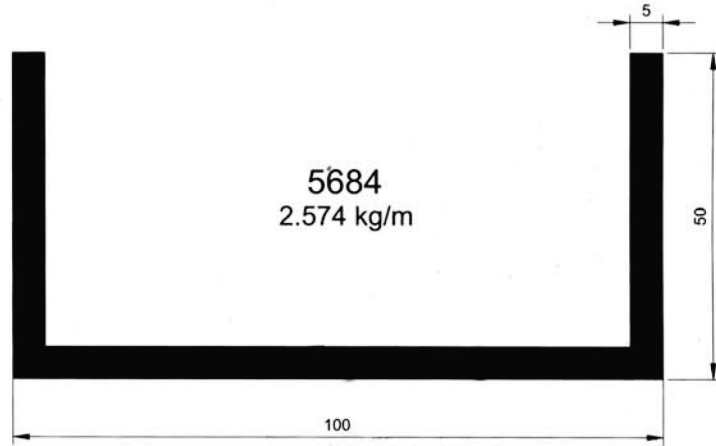

5684
2.574 kg/m

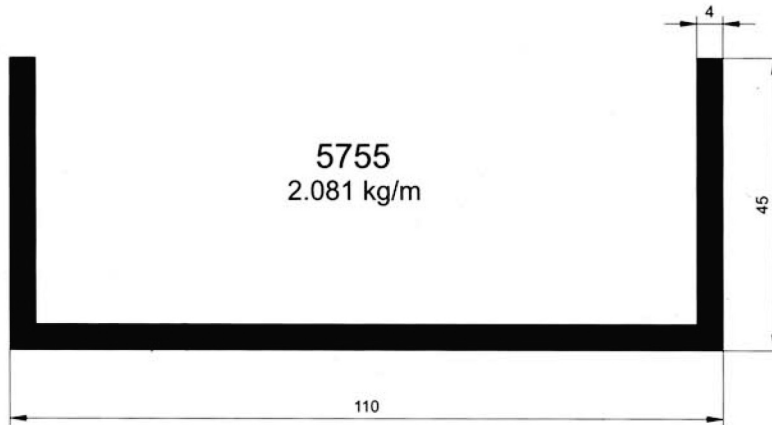

5755
2.081 kg/m



OSMANLI
ALÜMİNYUM SAN. ve TİC. LTD. ŞTİ.

- ❖ ÖZEL EBATLARDA BORU, KUTU, LAMA, KÖŞEBENT ÇEŞİTLERİ
- ❖ AYDINLATMA ve REKLAM PROFİLLERİ
- ❖ SOĞUTUCU ve LED PROFİLLERİ
- ❖ MOBİLYA ve SANAYİ PROFİLLERİ
- ❖ ÖZEL KALIP ÇİZİMLERİ ve İMALATI
- ❖ ELOKSALLI ve PRES PLAKA LEVHALARI
- ❖ GOFRAJLI ve DÜZ PARLAK RULO LEVHALARI
- ❖ LEVHA KESİM - BÜKÜM (ÖZEL ÖLÇÜLERİNİZDE)
- ❖ DELİKLİ ve DEKORATİF TELLER
- ❖ PLEXI - FOLYO - DEKOTE - POLYCARBON - KOMPOZİT VB.

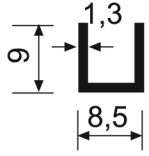

303

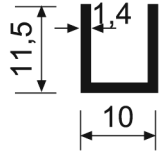

306

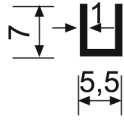

435

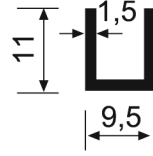

504

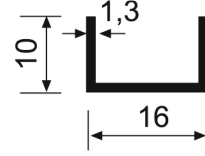

558

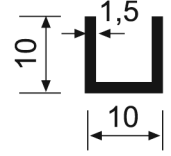

559

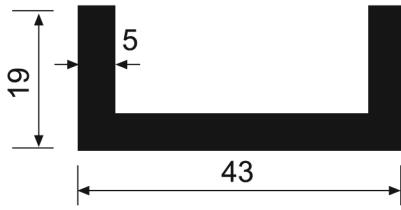

642

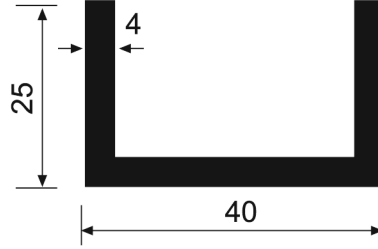

647

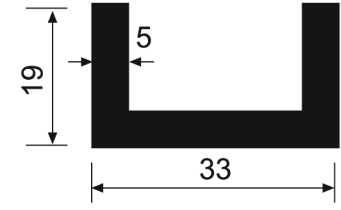

879

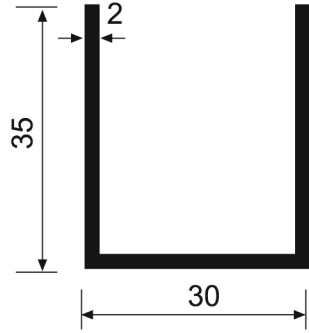

653

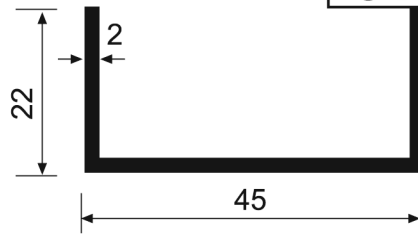

884

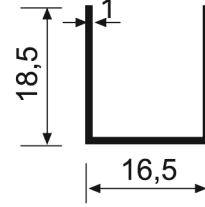

1052

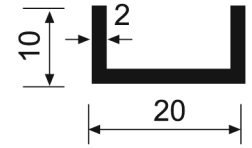

1042

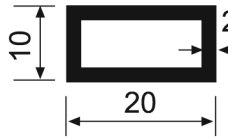

2448

(0.285 kg/m.)

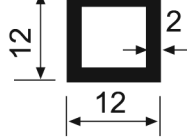

2449

(0.220 kg/m.)

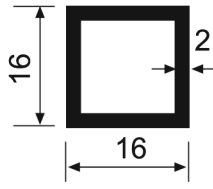

2450

(0.305 kg/m.)

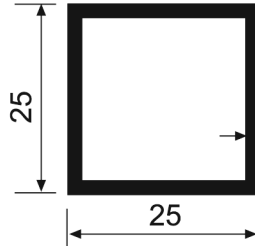

2451

(0.500 kg/m.)

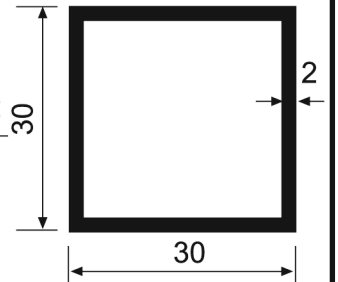

2452

(0.610 kg/m.)

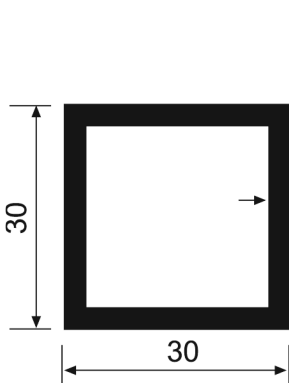

2453

(0.880 kg/m.)

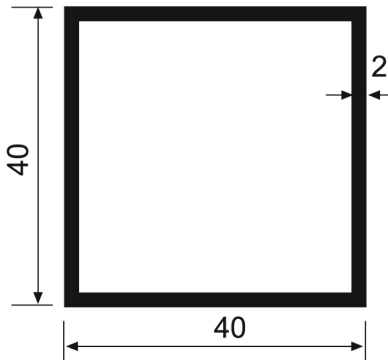

2454

(0.825 kg/m.)

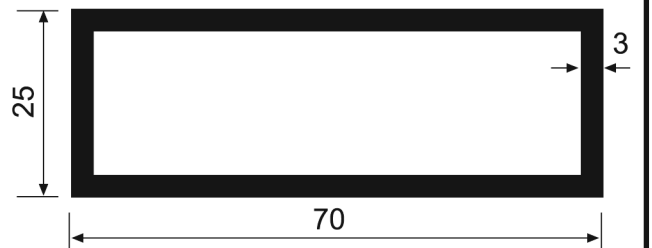

2455

(1.450 kg/m.)



OSMANLI
ALÜMİNYUM SAN. ve TİC. LTD. ŞTİ.

- ❖ ÖZEL EBATLARDA BORU, KUTU, LAMA, KÖŞEBENT ÇEŞİTLERİ
- ❖ AYDINLATMA ve REKLAM PROFİLLERİ
- ❖ SOĞUTUCU ve LED PROFİLLERİ
- ❖ MOBİLYA ve SANAYİ PROFİLLERİ
- ❖ ÖZEL KALIP ÇİZİMLERİ ve İMALATI
- ❖ ELOKSALLI ve PRES PLAKA LEVHALARI
- ❖ GOFRAJLI ve DÜZ PARLAK RULO LEVHALARI
- ❖ LEVHA KESİM - BÜKÜM (ÖZEL ÖLÇÜLERİNİZDE)
- ❖ DELİKLİ ve DEKORATİF TELLER
- ❖ PLEXI - FOLYO - DEKOTE - POLYCARBON - KOMPOZİT VB.

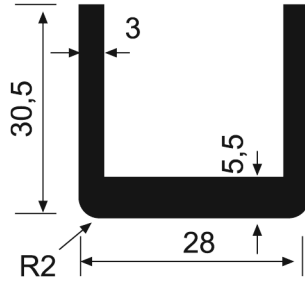

273

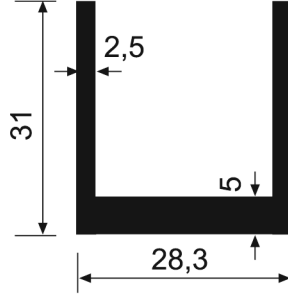

274

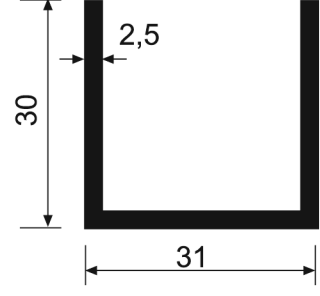

275

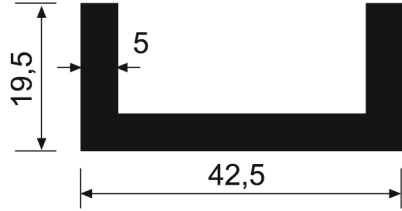

276

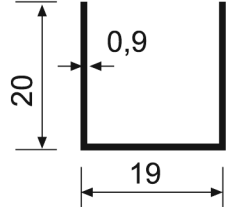

250

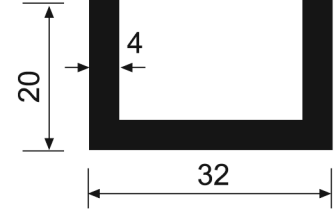

277

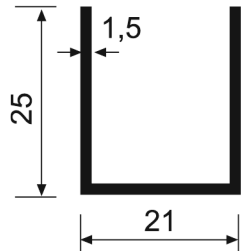

278

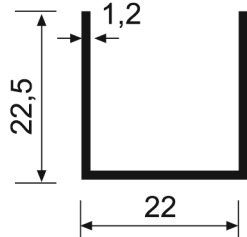

279

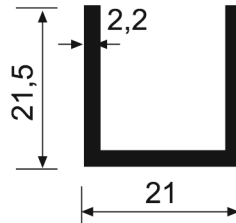

281

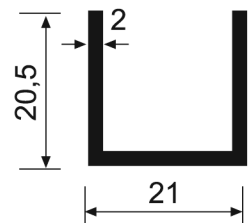

284

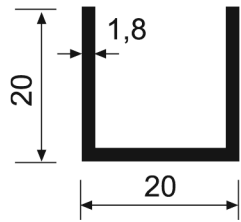

285

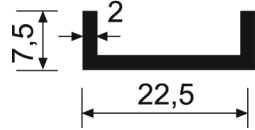

287

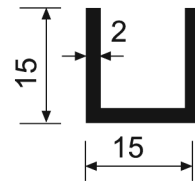

289

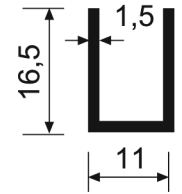

291

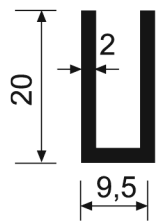

293

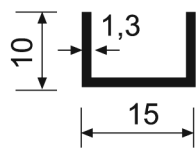

294

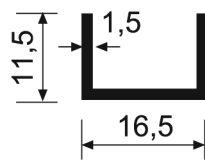

295

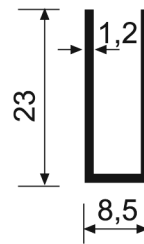

297

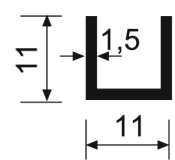

302



OSMANLI
ALÜMİNYUM SAN. ve TİC. LTD .ŞTİ.

- ❖ ÖZEL EBATLARDA BORU, KUTU, LAMA, KÖŞEBENT ÇEŞİTLERİ
- ❖ AYDINLATMA ve REKLAM PROFİLLERİ
- ❖ SOĞUTUCU ve LED PROFİLLERİ
- ❖ MOBİLYA ve SANAYİ PROFİLLERİ
- ❖ ÖZEL KALIP ÇİZİMLERİ ve İMALATI
- ❖ ELOKSALLI ve PRES PLAKA LEVHALARI
- ❖ GOFRAJLI ve DÜZ PARLAK RULO LEVHALARI
- ❖ LEVHA KESİM - BÜKÜM (ÖZEL ÖLÇÜLERİNİZDE)
- ❖ DELİKLİ ve DEKORATİF TELLER
- ❖ PLEXI - FOLYO - DEKOTE - POLYCARBON - KOMPOZİT VB.

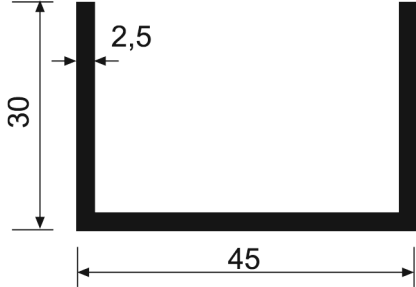

1822

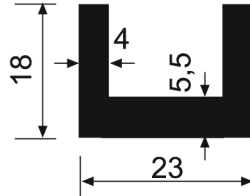

1823

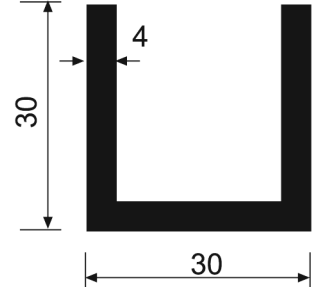

1824

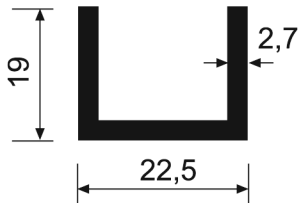

1825

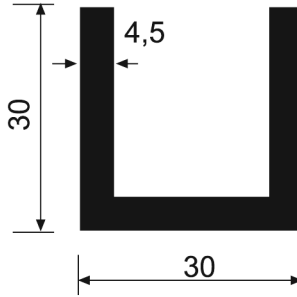

1826

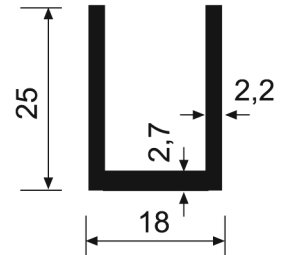

1827

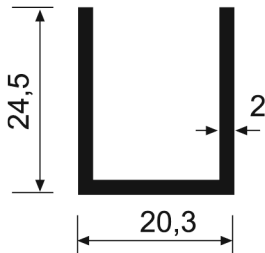

1828

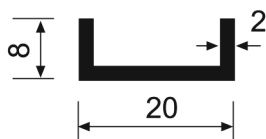

1829

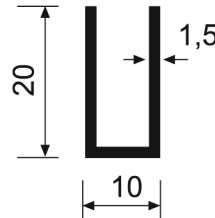

1830

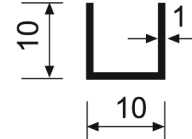

1831

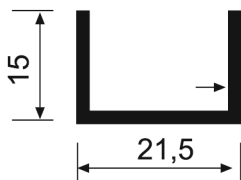

1832

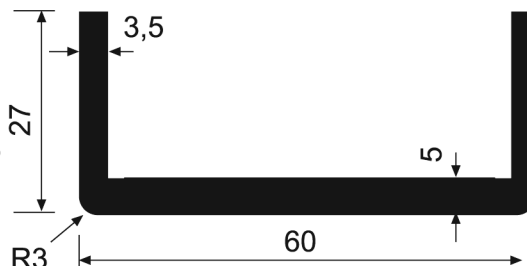

271

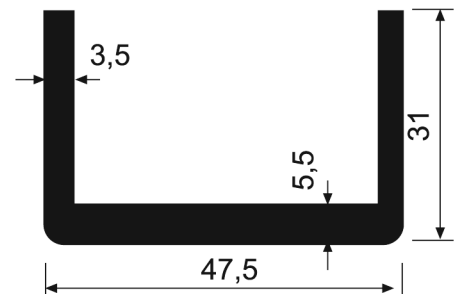

272



OSMANLI
ALÜMİNYUM SAN. ve TİC. LTD .ŞTİ.

- ❖ ÖZEL EBATLARDA BORU, KUTU, LAMA, KÖŞEBENT ÇEŞİTLERİ
- ❖ AYDINLATMA ve REKLAM PROFİLLERİ
- ❖ SOĞUTUCU ve LED PROFİLLERİ
- ❖ MOBİLYA ve SANAYİ PROFİLLERİ
- ❖ ÖZEL KALIP ÇİZİMLERİ ve İMALATI
- ❖ ELOKSALLI ve PRES PLAKA LEVHALARI
- ❖ GOFRAJLI ve DÜZ PARLAK RULO LEVHALARI
- ❖ LEVHA KESİM - BÜKÜM (ÖZEL ÖLÇÜLERİNİZDE)
- ❖ DELİKLİ ve DEKORATİF TELLER
- ❖ PLEXI - FOLYO - DEKOTE - POLYCARBON - KOMPOZİT VB.

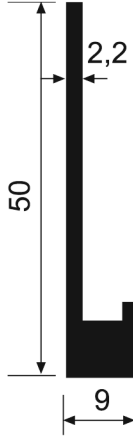

316

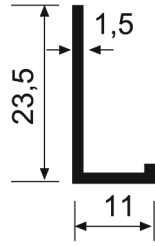

355

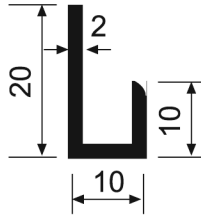

3

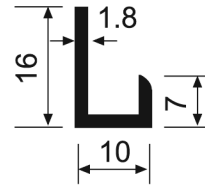

5

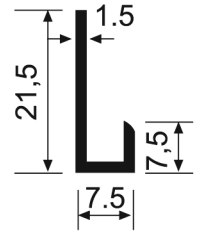

225

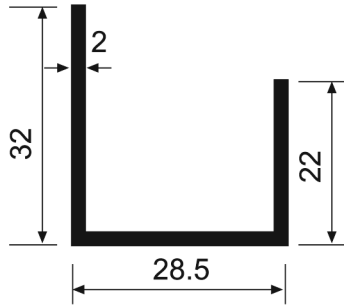

1254

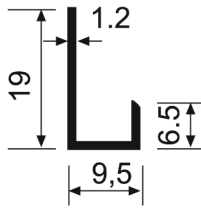

798

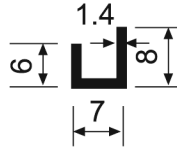

803

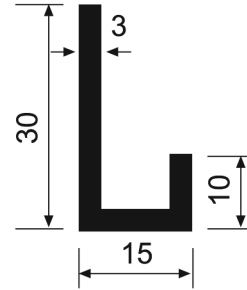

808

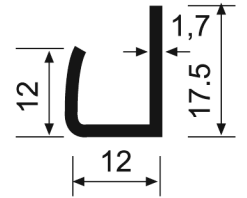

296

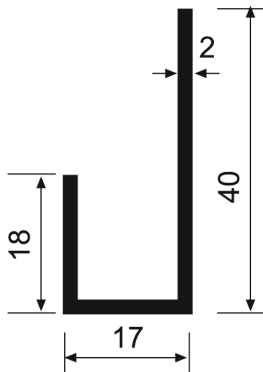

1089

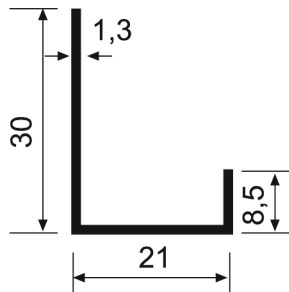

1283

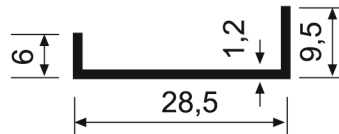

441

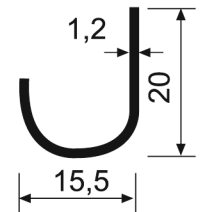

520



OSMANLI
ALÜMİNYUM SAN. ve TİC. LTD .ŞTİ.

- ❖ ÖZEL EBATLARDA BORU, KUTU, LAMA, KÖŞEBENT ÇEŞİTLERİ
- ❖ AYDINLATMA ve REKLAM PROFİLLERİ
- ❖ SOĞUTUCU ve LED PROFİLLERİ
- ❖ MOBİLYA ve SANAYİ PROFİLLERİ
- ❖ ÖZEL KALIP ÇİZİMLERİ ve İMALATI
- ❖ ELOKSALLI ve PRES PLAKA LEVHALARI
- ❖ GOFRAJLI ve DÜZ PARLAK RULO LEVHALARI
- ❖ LEVHA KESİM - BÜKÜM (ÖZEL ÖLÇÜLERİNİZDE)
- ❖ DELİKLİ ve DEKORATİF TELLER
- ❖ PLEXI - FOLYO - DEKOTE - POLYCARBON - KOMPOZİT VB.

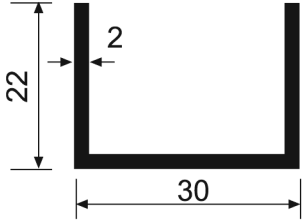

1869

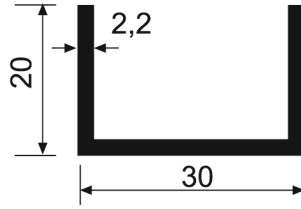

1870

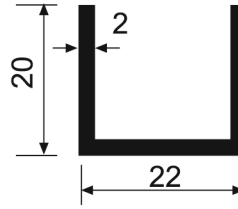

1872

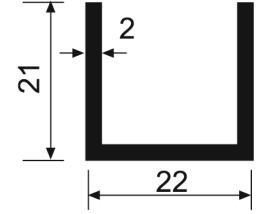

1873

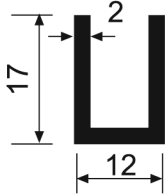

1883

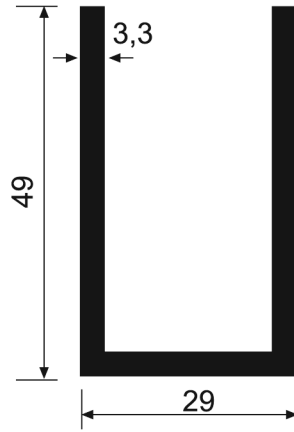

1874

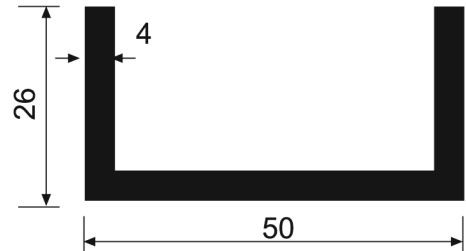

1875

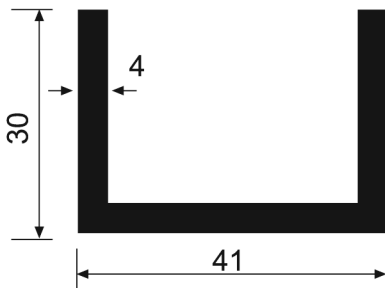

1876

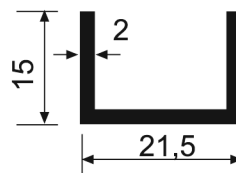

1886

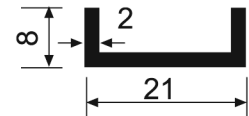

1889

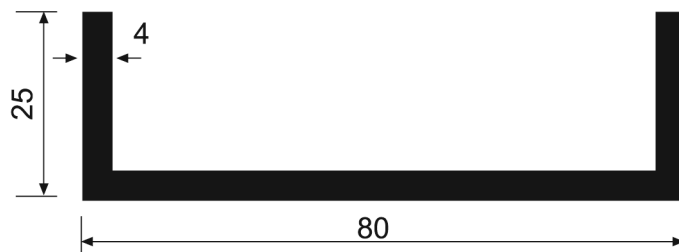

1887



OSMANLI
ALÜMİNYUM SAN. ve TİC. LTD. ŞTİ.

- ❖ ÖZEL EBATLARDA BORU, KUTU, LAMA, KÖŞEBENT ÇEŞİTLERİ
- ❖ AYDINLATMA ve REKLAM PROFİLLERİ
- ❖ SOĞUTUCU ve LED PROFİLLERİ
- ❖ MOBİLYA ve SANAYİ PROFİLLERİ
- ❖ ÖZEL KALIP ÇİZİMLERİ ve İMALATI
- ❖ ELOKSALLI ve PRES PLAKA LEVHALARI
- ❖ GOFRAJLI ve DÜZ PARLAK RULO LEVHALARI
- ❖ LEVHA KESİM - BÜKÜM (ÖZEL ÖLÇÜLERİNİZDE)
- ❖ DELİKLİ ve DEKORATİF TELLER
- ❖ PLEXI - FOLYO - DEKOTE - POLYCARBON - KOMPOZİT VB.

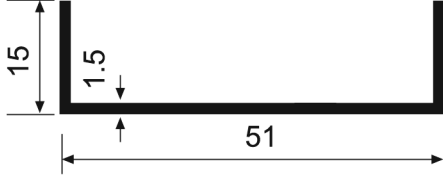

1087

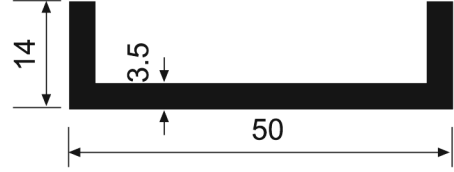

1092

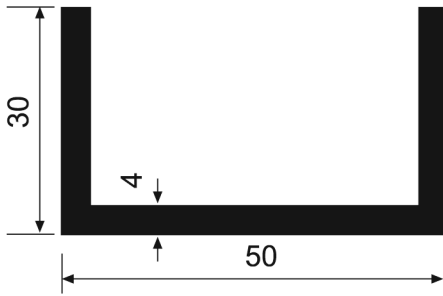

1215

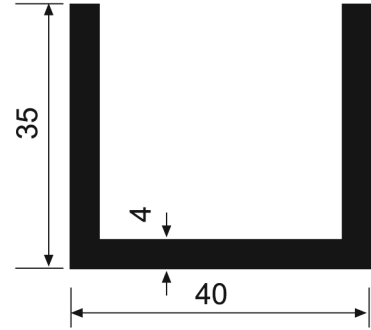

1249

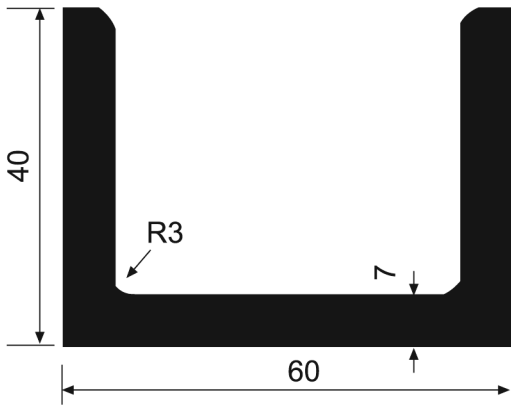

714

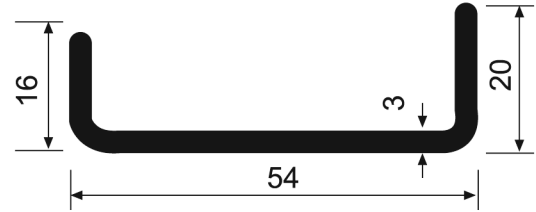

1361

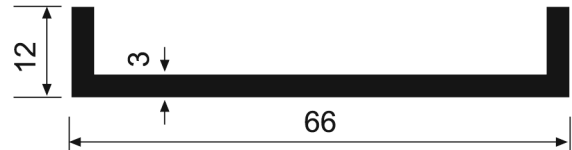

1035

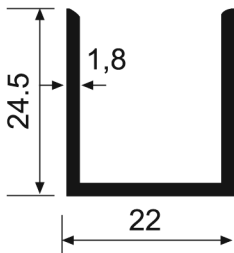

283

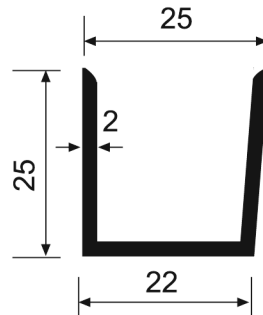

280

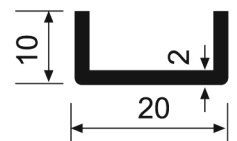

451



OSMANLI
ALÜMİNYUM SAN. ve TİC. LTD .ŞTİ.

- ❖ ÖZEL EBATLARDA BORU, KUTU, LAMA, KÖŞEBENT ÇEŞİTLERİ
- ❖ AYDINLATMA ve REKLAM PROFİLLERİ
- ❖ SOĞUTUCU ve LED PROFİLLERİ
- ❖ MOBİLYA ve SANAYİ PROFİLLERİ
- ❖ ÖZEL KALIP ÇİZİMLERİ ve İMALATI
- ❖ ELOKSALLI ve PRES PLAKA LEVHALARI
- ❖ GOFRAJLI ve DÜZ PARLAK RULO LEVHALARI
- ❖ LEVHA KESİM - BÜKÜM (ÖZEL ÖLÇÜLERİNİZDE)
- ❖ DELİKLİ ve DEKORATİF TELLER
- ❖ PLEXI - FOLYO - DEKOTE - POLYCARBON - KOMPOZİT VB.

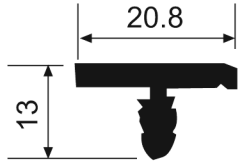

1774

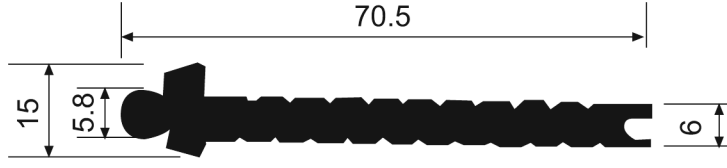

1773

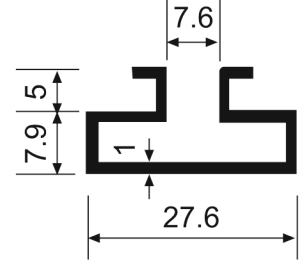

810

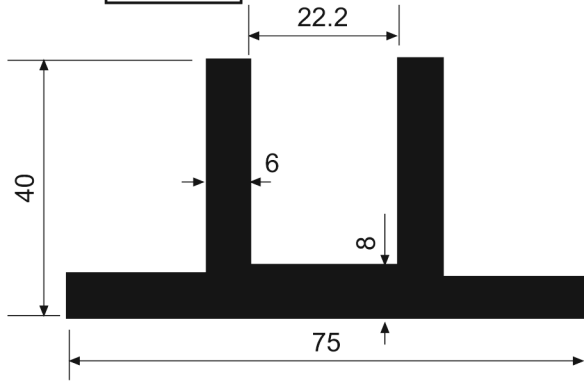

1176

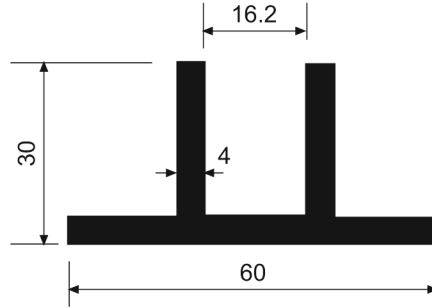

1177

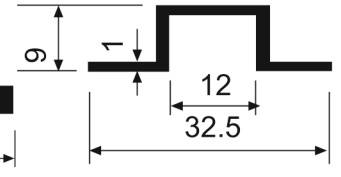

915

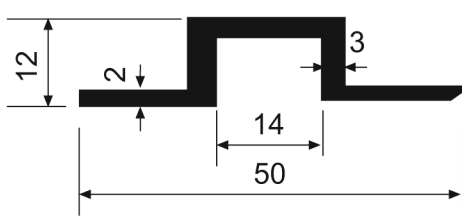

1660

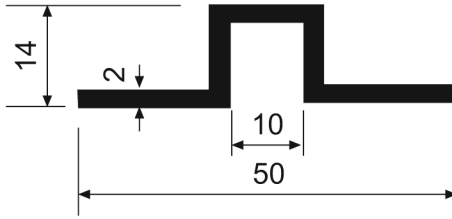

1661

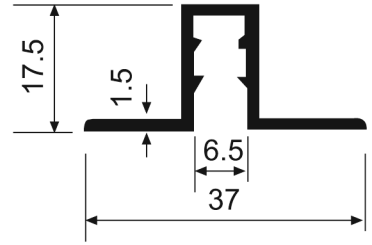

1663

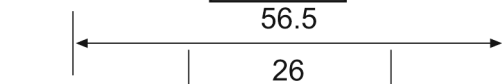

1381

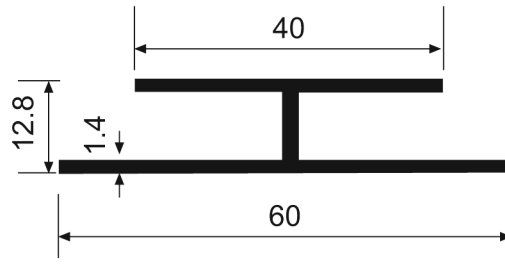

805

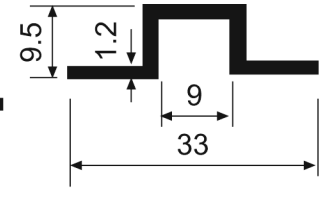

1664

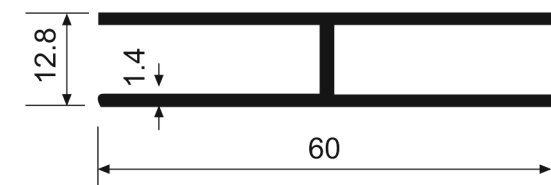

804

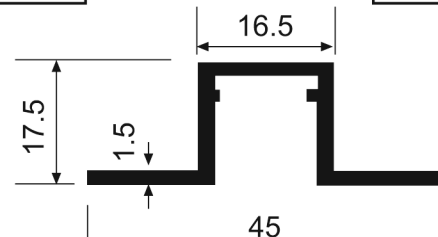

1281

84



OSMANLI
ALÜMİNYUM SAN. ve TİC. LTD .ŞTİ.

- ❖ ÖZEL EBATLARDA BORU, KUTU, LAMA, KÖŞEBENT ÇEŞİTLERİ
- ❖ AYDINLATMA ve REKLAM PROFİLLERİ
- ❖ SOĞUTUCU ve LED PROFİLLERİ
- ❖ MOBİLYA ve SANAYİ PROFİLLERİ
- ❖ ÖZEL KALIP ÇİZİMLERİ ve İMALATI
- ❖ ELOKSALLI ve PRES PLAKA LEVHALARI
- ❖ GOFRAJLI ve DÜZ PARLAK RULO LEVHALARI
- ❖ LEVHA KESİM - BÜKÜM (ÖZEL ÖLÇÜLERİNİZDE)
- ❖ DELİKLİ ve DEKORATİF TELLER
- ❖ PLEXI - FOLYO - DEKOTE - POLYCARBON - KOMPOZİT VB.

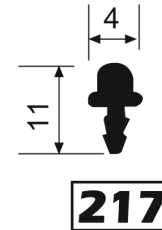
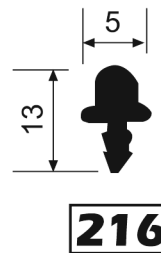
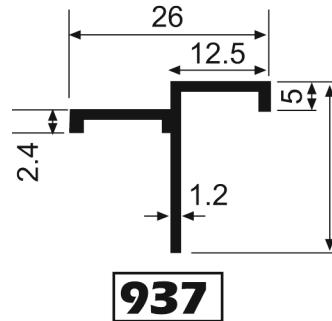
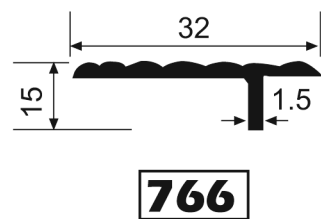
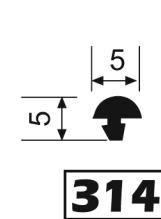
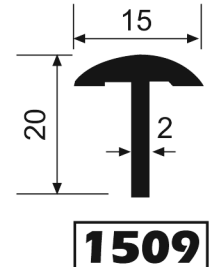
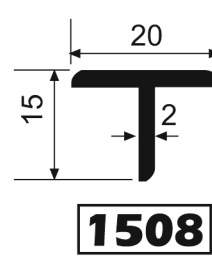
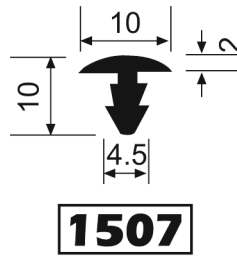
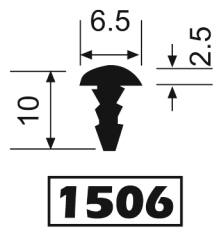
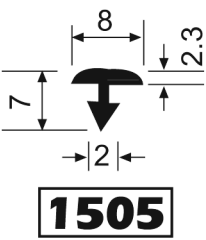
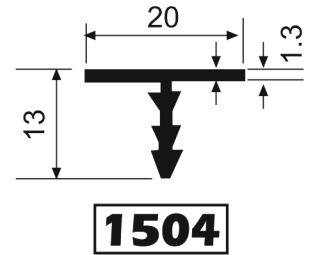
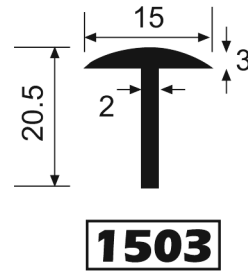
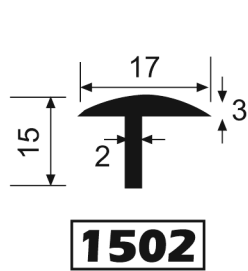
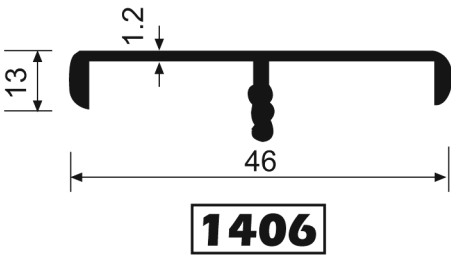
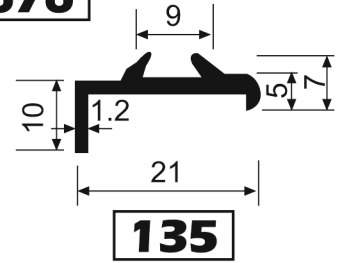
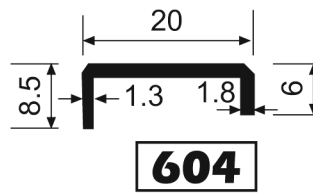
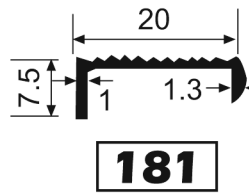
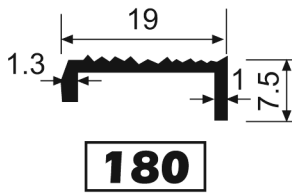
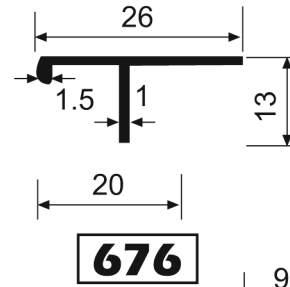
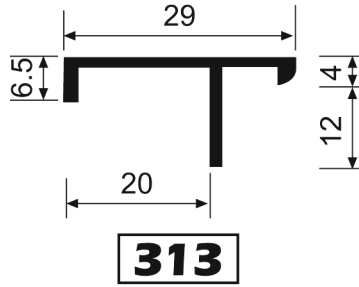
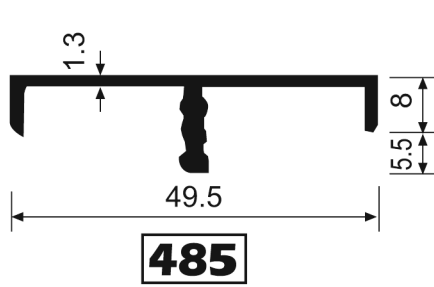
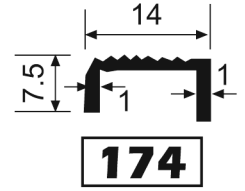
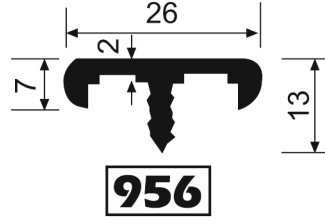
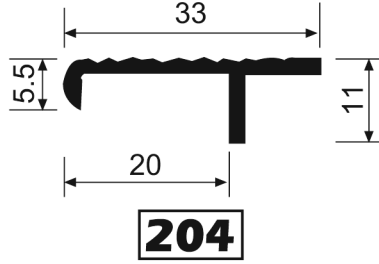
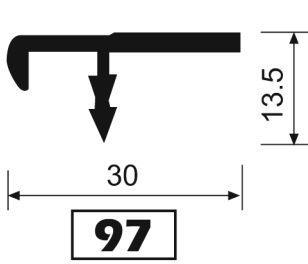



OSMANLI
ALÜMİNYUM SAN. ve TİC. LTD. ŞTİ.

- ❖ ÖZEL EBATLARDA BORU, KUTU, LAMA, KÖŞEBENT ÇEŞİTLERİ
- ❖ AYDINLATMA ve REKLAM PROFİLLERİ
- ❖ SOĞUTUCU ve LED PROFİLLERİ
- ❖ MOBİLYA ve SANAYİ PROFİLLERİ
- ❖ ÖZEL KALIP ÇİZİMLERİ ve İMALATI
- ❖ ELOKSALLI ve PRES PLAKA LEVHALARI
- ❖ GOFRAJLI ve DÜZ PARLAK RULO LEVHALARI
- ❖ LEVHA KESİM - BÜKÜM (ÖZEL ÖLÇÜLERİNİZDE)
- ❖ DELİKLİ ve DEKORATİF TELLER
- ❖ PLEXI - FOLYO - DEKOTE - POLYCARBON - KOMPOZİT VB.

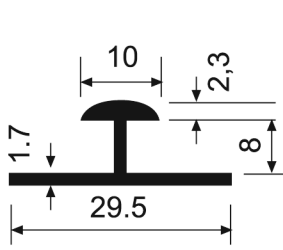

29

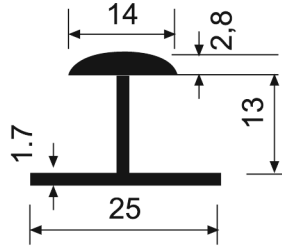

30

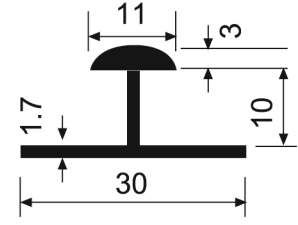

31

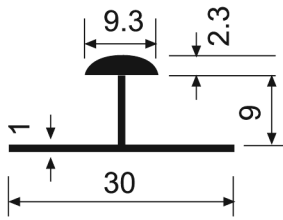

552

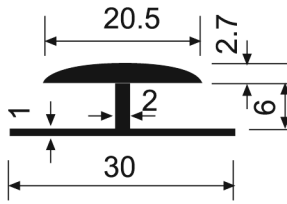

572

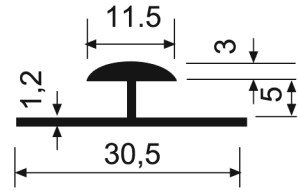

973

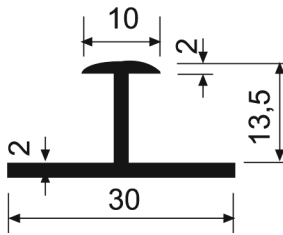

829

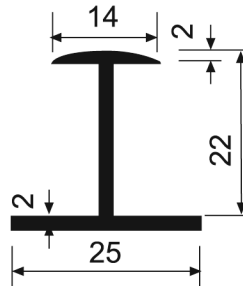

916

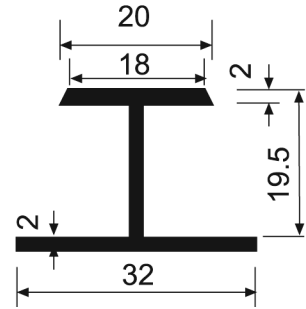

876

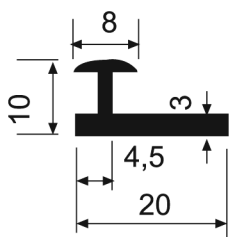

1208

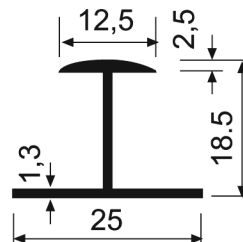

1242

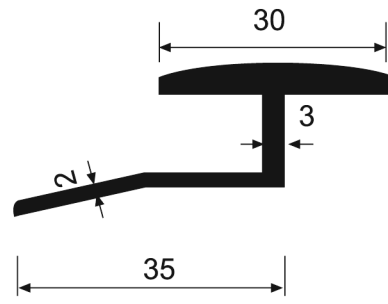

1218

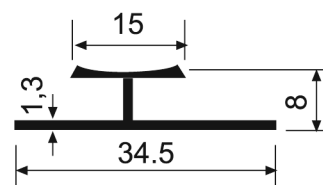

955

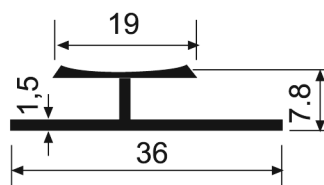

972

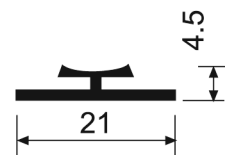

82



OSMANLI
ALÜMİNYUM SAN. ve TİC. LTD. ŞTİ.

- ❖ ÖZEL EBATLARDA BORU, KUTU, LAMA, KÖŞEBENT ÇEŞİTLERİ
- ❖ AYDINLATMA ve REKLAM PROFİLLERİ
- ❖ SOĞUTUCU ve LED PROFİLLERİ
- ❖ MOBİLYA ve SANAYİ PROFİLLERİ
- ❖ ÖZEL KALIP ÇİZİMLERİ ve İMALATI
- ❖ ELOKSALLI ve PRES PLAKA LEVHALARI
- ❖ GOFRAJLI ve DÜZ PARLAK RULO LEVHALARI
- ❖ LEVHA KESİM - BÜKÜM (ÖZEL ÖLÇÜLERİNİZDE)
- ❖ DELİKLİ ve DEKORATİF TELLER
- ❖ PLEXI - FOLYO - DEKOTE - POLYCARBON - KOMPOZİT VB.

HALI VE PARKE PROFİLLERİ (2)



1815

(0,230 Kg/m)



1878

(0,275 Kg/m)



1874

(0,195 Kg/m)



1875

(0,125 Kg/m)



1876

(0,135 Kg/m)



1877

(0,250 Kg/m)

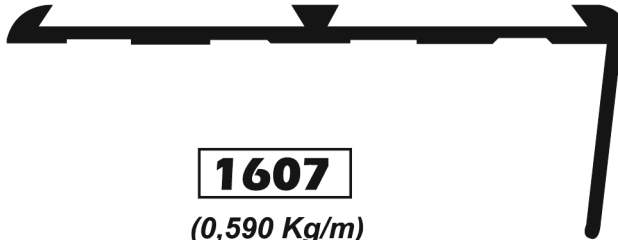

1607

(0,590 Kg/m)



1867

(0,250 Kg/m)



1866

(0,130 Kg/m)



OSMANLI
ALÜMİNYUM SAN. ve TİC. LTD. ŞTİ.

- ❖ ÖZEL EBATLARDA BORU, KUTU, LAMA, KÖŞEBENT ÇEŞİTLERİ
- ❖ AYDINLATMA ve REKLAM PROFİLLERİ
- ❖ SOĞUTUCU ve LED PROFİLLERİ
- ❖ MOBİLYA ve SANAYİ PROFİLLERİ
- ❖ ÖZEL KALIP ÇİZİMLERİ ve İMALATI
- ❖ ELOKSALLI ve PRES PLAKA LEVHALARI
- ❖ GOFRAJLI ve DÜZ PARLAK RULO LEVHALARI
- ❖ LEVHA KESİM - BÜKÜM (ÖZEL ÖLÇÜLERİNİZDE)
- ❖ DELİKLİ ve DEKORATİF TELLER
- ❖ PLEXI - FOLYO - DEKOTE - POLYCARBON - KOMPOZİT VB.

HALI VE PARKE PROFİLLERİ (1)

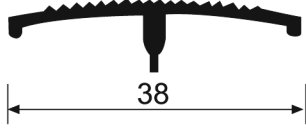

1703

(0,210 Kg/m)

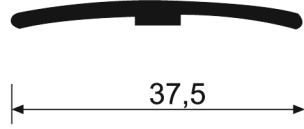

1599

(0,220 Kg/m)

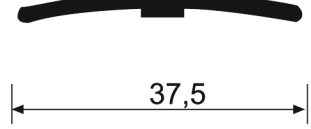

1551

(0,180 Kg/m)



1704

(0,310 Kg/m)

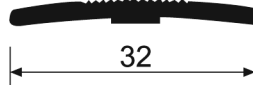

1835

(0,180 Kg/m)



1834

(0,190 Kg/m)

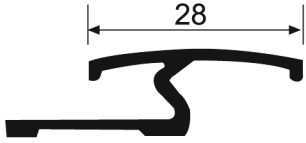

1605

(0,270 Kg/m)

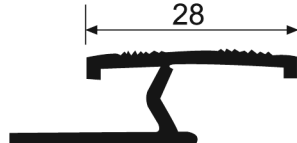

1605-T

(0,260 Kg/m)

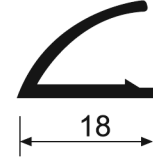

1603

(0,160 Kg/m)

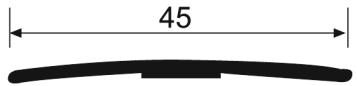

1706

(0,240 Kg/m)

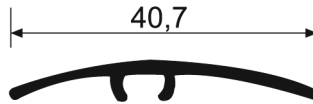

5201

(0,170 Kg/m)

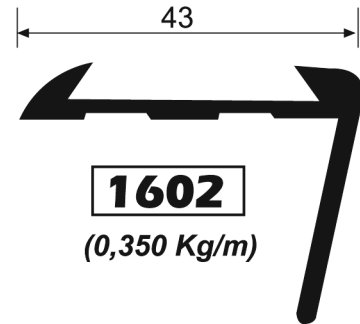

1602

(0,350 Kg/m)

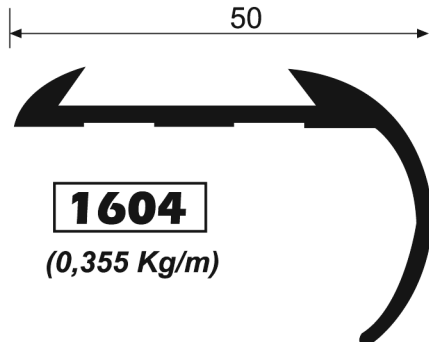

1604

(0,355 Kg/m)

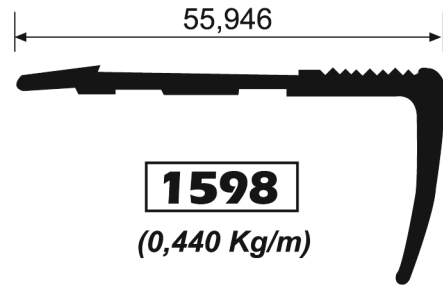

1598

(0,440 Kg/m)



OSMANLI
ALÜMİNYUM SAN. ve TİC. LTD. ŞTİ.

- ❖ ÖZEL EBATLARDA BORU, KUTU, LAMA, KÖŞEBENT ÇEŞİTLERİ
- ❖ AYDINLATMA ve REKLAM PROFİLLERİ
- ❖ SOĞUTUCU ve LED PROFİLLERİ
- ❖ MOBİLYA ve SANAYİ PROFİLLERİ
- ❖ ÖZEL KALIP ÇİZİMLERİ ve İMALATI
- ❖ ELOKSALLI ve PRES PLAKA LEVHALARI
- ❖ GOFRAJLI ve DÜZ PARLAK RULO LEVHALARI
- ❖ LEVHA KESİM - BÜKÜM (ÖZEL ÖLÇÜLERİNİZDE)
- ❖ DELİKLİ ve DEKORATİF TELLER
- ❖ PLEXI - FOLYO - DEKOTE - POLYCARBON - KOMPOZİT VB.

HALI PARKE SÜPÜRGELİK VE BASAMAK PROFİLLERİ

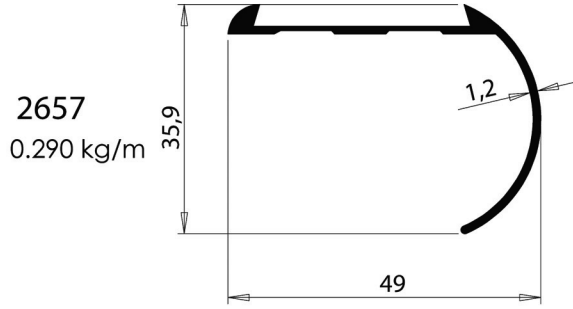

5105
0,098 kg/m

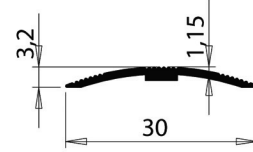

5582
0,266 kg/m

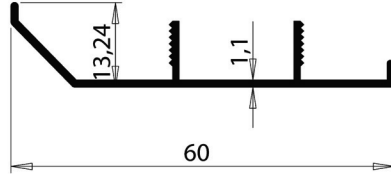

5125
0,130 kg/m

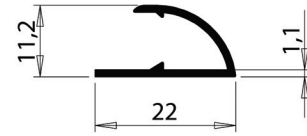

5530
0,210 kg/m

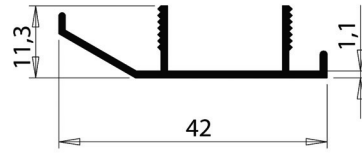

5049
0,146 kg/m

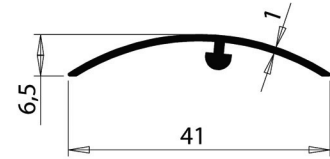

4467
0,250 kg/m

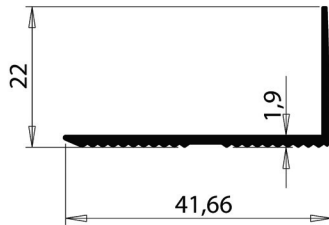

3999
0,168 kg/m

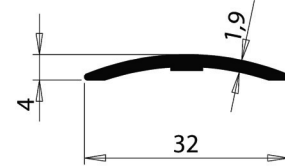

5201
0,258 kg/m

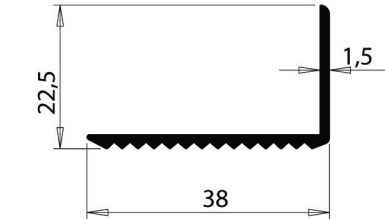

5000
0,080 kg/m

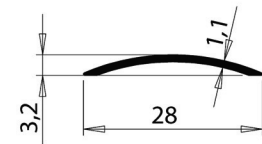

6783
0,179 kg/m

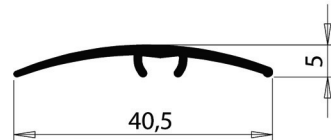

6784
0,120 kg/m

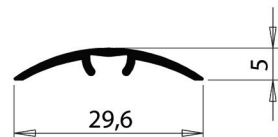

5006
0,185 kg/m

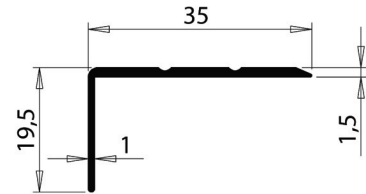



OSMANLI
ALÜMİNYUM SAN. ve TİC. LTD .ŞTİ.

- ❖ ÖZEL EBATLARDA BORU, KUTU, LAMA, KÖŞEBENT ÇEŞİTLERİ
- ❖ AYDINLATMA ve REKLAM PROFİLLERİ
- ❖ SOĞUTUCU ve LED PROFİLLERİ
- ❖ MOBİLYA ve SANAYİ PROFİLLERİ
- ❖ ÖZEL KALIP ÇİZİMLERİ ve İMALATI
- ❖ ELOKSALLI ve PRES PLAKA LEVHALARI
- ❖ GOFRAJLI ve DÜZ PARLAK RULO LEVHALARI
- ❖ LEVHA KESİM - BÜKÜM (ÖZEL ÖLÇÜLERİNİZDE)
- ❖ DELİKLİ ve DEKORATİF TELLER
- ❖ PLEXI - FOLYO - DEKOTE - POLYCARBON - KOMPOZİT VB.

SÜPÜRGELİK PROFİLLERİ

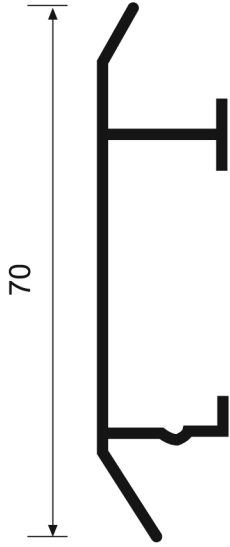

2500

(0,410 Kg/m)

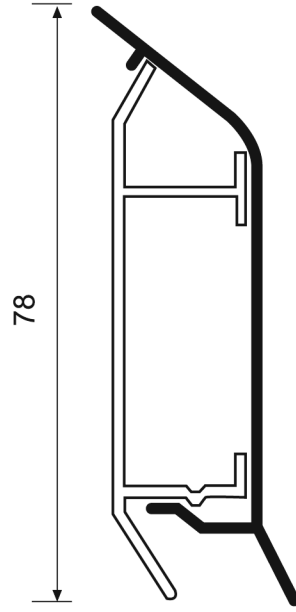

2501

(0,370 Kg/m)

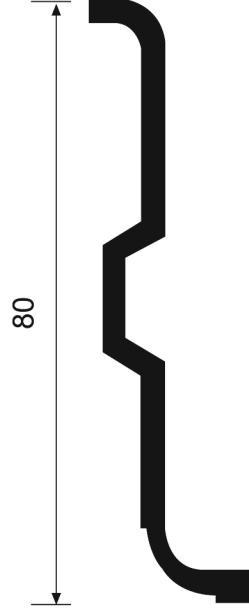

1084

(0,700 Kg/m)

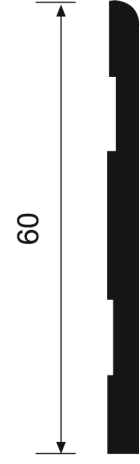

1863

(0,590 Kg/m)

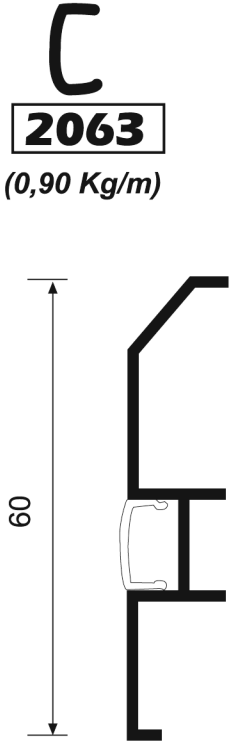

2063

(0,90 Kg/m)

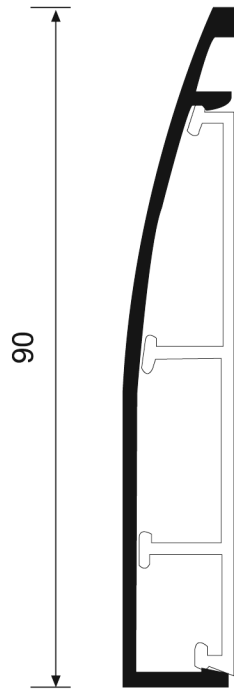

1796

(0,450 Kg/m)

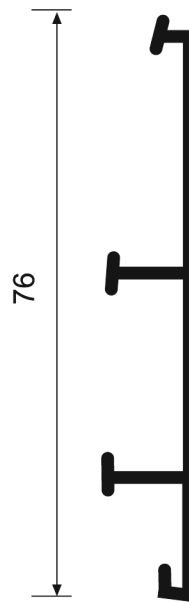

1795

(0,485 Kg/m)

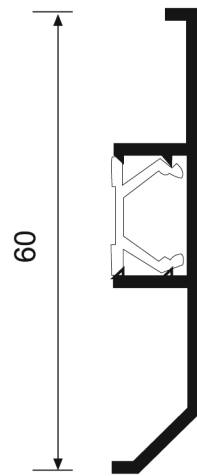

1861

(0,310 Kg/m)



OSMANLI
ALÜMİNYUM SAN. ve TİC. LTD .ŞTİ.

- ❖ ÖZEL EBATLARDA BORU, KUTU, LAMA, KÖŞEBENT ÇEŞİTLERİ
- ❖ AYDINLATMA ve REKLAM PROFİLLERİ
- ❖ SOĞUTUCU ve LED PROFİLLERİ
- ❖ MOBİLYA ve SANAYİ PROFİLLERİ
- ❖ ÖZEL KALIP ÇİZİMLERİ ve İMALATI
- ❖ ELOKSALLI ve PRES PLAKA LEVHALARI
- ❖ GOFRAJLI ve DÜZ PARLAK RULO LEVHALARI
- ❖ LEVHA KESİM - BÜKÜM (ÖZEL ÖLÇÜLERİNİZDE)
- ❖ DELİKLİ ve DEKORATİF TELLER
- ❖ PLEXI - FOLYO - DEKOTE - POLYCARBON - KOMPOZİT VB.

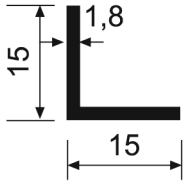

1900

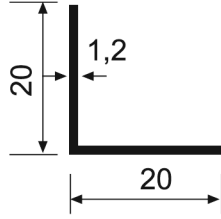

1901

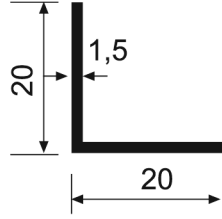

1902

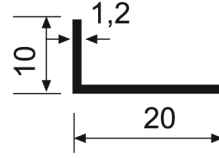

1903

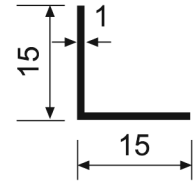

1904

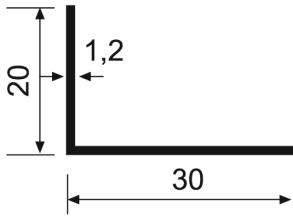

1905

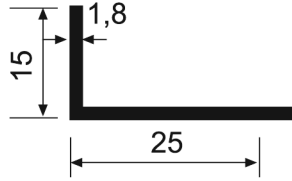

1906

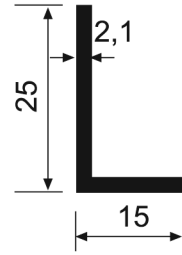

1907

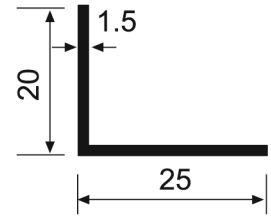

1908

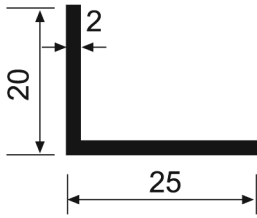

1917

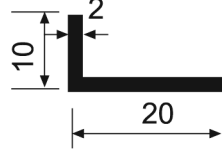

1924

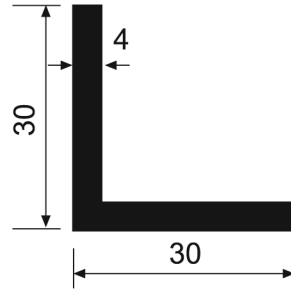

1928

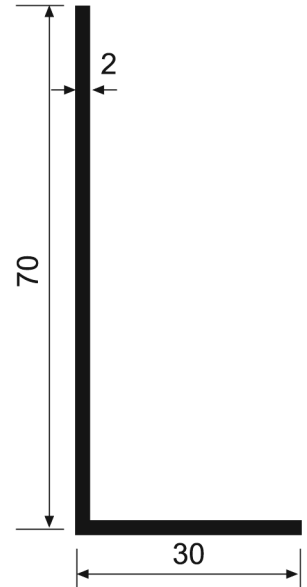

1953

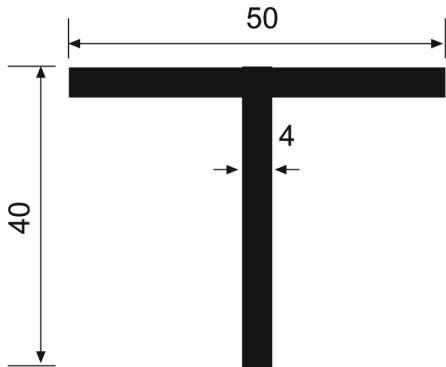

993

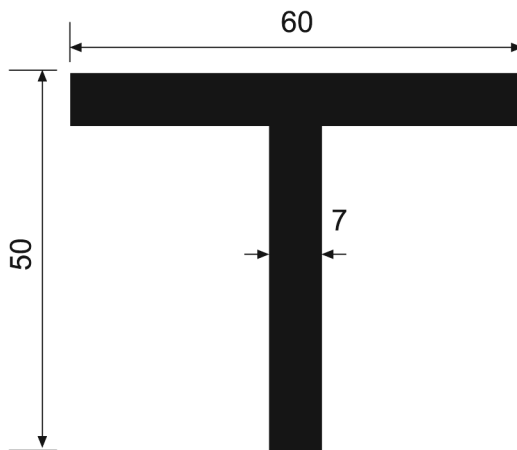

1103



OSMANLI
ALÜMİNYUM SAN. ve TİC. LTD. ŞTİ.

- ❖ ÖZEL EBATLARDA BORU, KUTU, LAMA, KÖŞEBENT ÇEŞİTLERİ
- ❖ AYDINLATMA ve REKLAM PROFİLLERİ
- ❖ SOĞUTUCU ve LED PROFİLLERİ
- ❖ MOBİLYA ve SANAYİ PROFİLLERİ
- ❖ ÖZEL KALIP ÇİZİMLERİ ve İMALATI
- ❖ ELOKSALLI ve PRES PLAKA LEVHALARI
- ❖ GOFRAJLI ve DÜZ PARLAK RULO LEVHALARI
- ❖ LEVHA KESİM - BÜKÜM (ÖZEL ÖLÇÜLERİNİZDE)
- ❖ DELİKLİ ve DEKORATİF TELLER
- ❖ PLEXI - FOLYO - DEKOTE - POLYCARBON - KOMPOZİT VB.

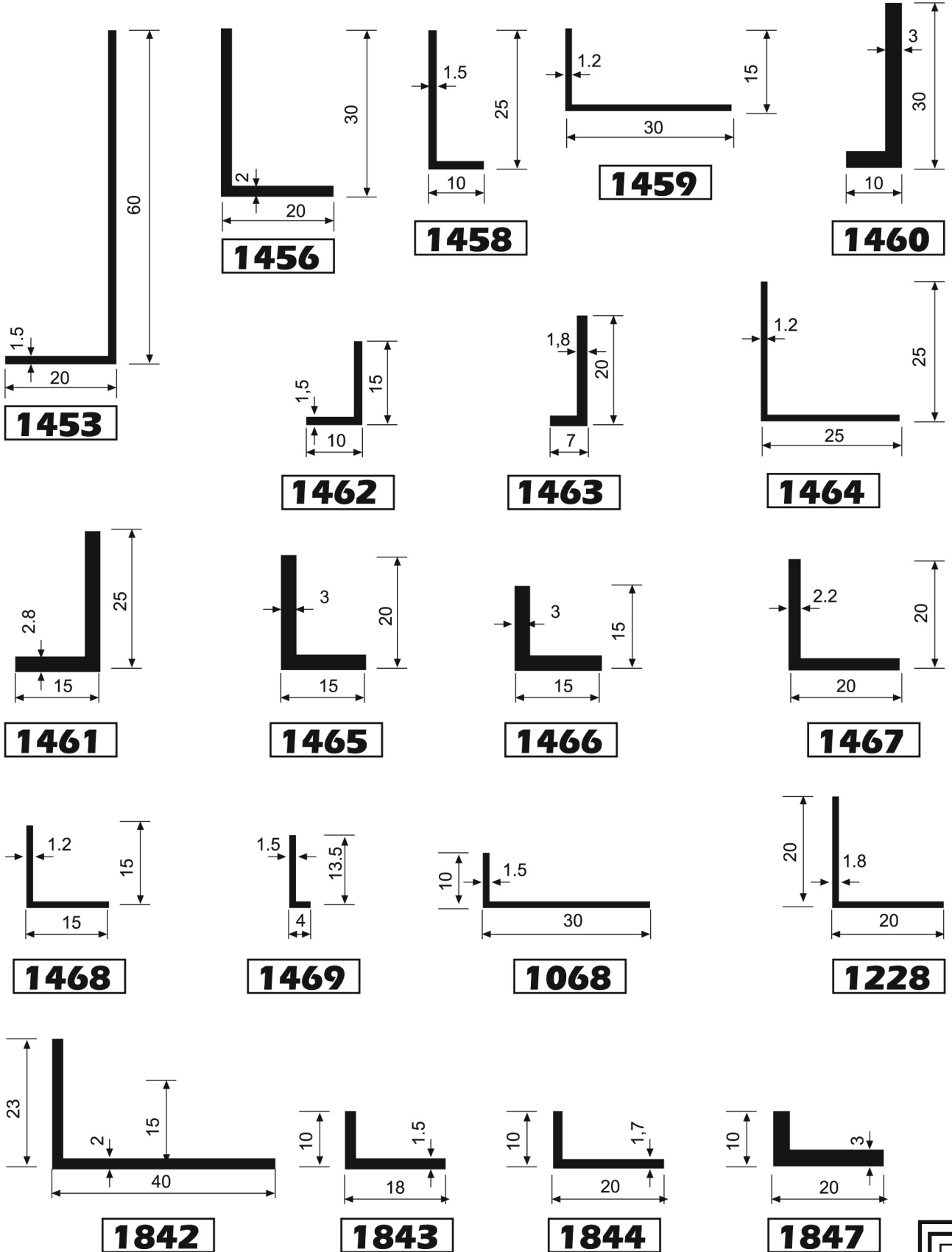



OSMANLI
ALÜMİNYUM SAN. ve TİC. LTD .ŞTİ.

- ❖ ÖZEL EBATLARDA BORU, KUTU, LAMA, KÖŞEBENT ÇEŞİTLERİ
- ❖ AYDINLATMA ve REKLAM PROFİLLERİ
- ❖ SOĞUTUCU ve LED PROFİLLERİ
- ❖ MOBİLYA ve SANAYİ PROFİLLERİ
- ❖ ÖZEL KALIP ÇİZİMLERİ ve İMALATI
- ❖ ELOKSALLI ve PRES PLAKA LEVHALARI
- ❖ GOFRAJLI ve DÜZ PARLAK RULO LEVHALARI
- ❖ LEVHA KESİM - BÜKÜM (ÖZEL ÖLÇÜLERİNİZDE)
- ❖ DELİKLİ ve DEKORATİF TELLER
- ❖ PLEXI - FOLYO - DEKOTE - POLYCARBON - KOMPOZİT VB.

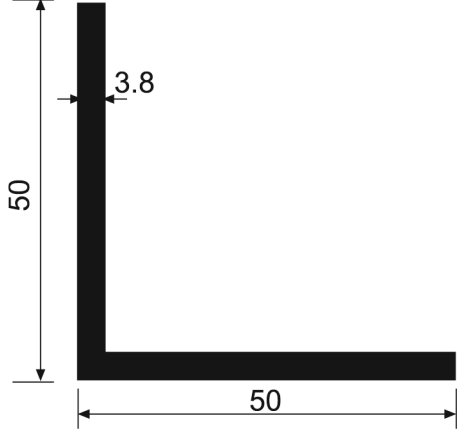

842

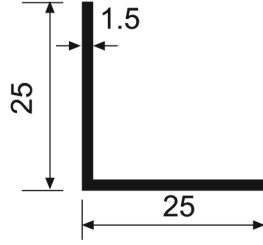

843

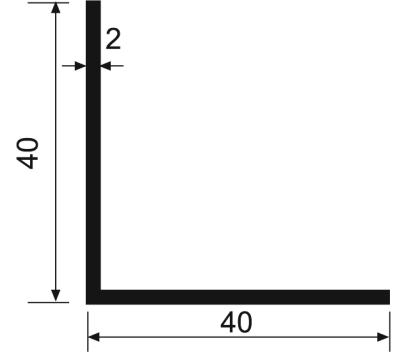

845

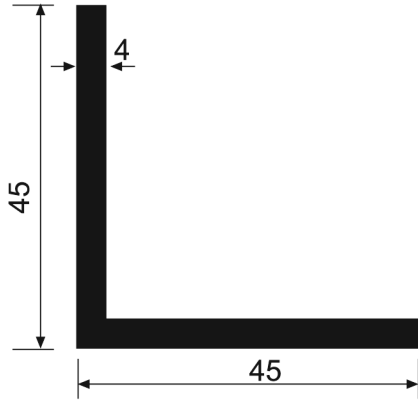

846

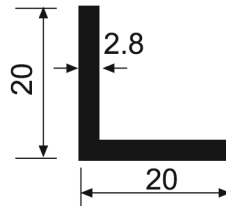

708

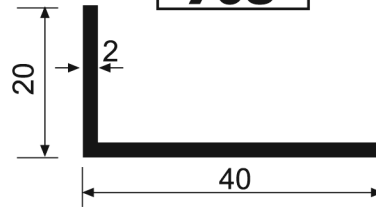

1069

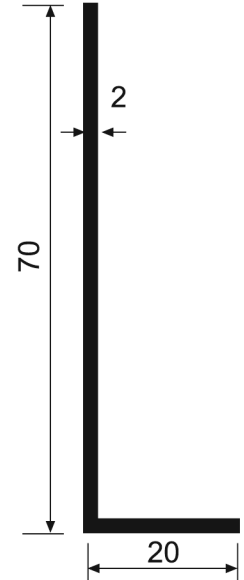

670

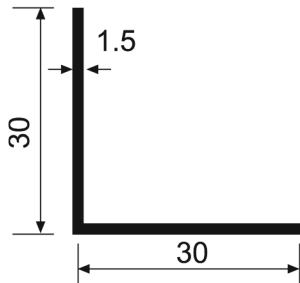

1067

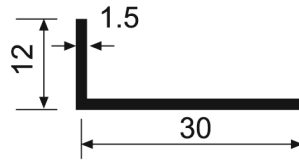

1457

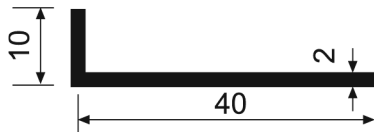

1455

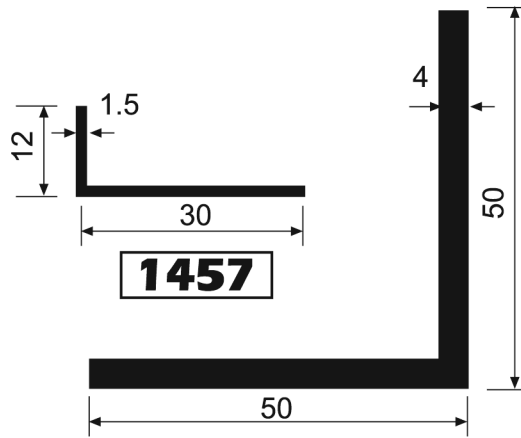

1452

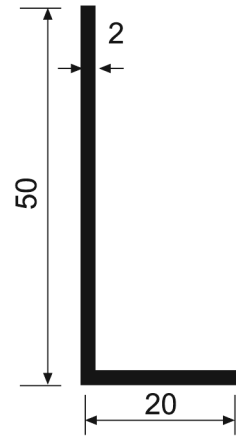

1454



OSMANLI
ALÜMİNYUM SAN. ve TİC. LTD .ŞTİ.

- ❖ ÖZEL EBATLARDA BORU, KUTU, LAMA, KÖŞEBENT ÇEŞİTLERİ
- ❖ AYDINLATMA ve REKLAM PROFİLLERİ
- ❖ SOĞUTUCU ve LED PROFİLLERİ
- ❖ MOBİLYA ve SANAYİ PROFİLLERİ
- ❖ ÖZEL KALIP ÇİZİMLERİ ve İMALATI
- ❖ ELOKSALLI ve PRES PLAKA LEVHALARI
- ❖ GOFRAJLI ve DÜZ PARLAK RULO LEVHALARI
- ❖ LEVHA KESİM - BÜKÜM (ÖZEL ÖLÇÜLERİNİZDE)
- ❖ DELİKLİ ve DEKORATİF TELLER
- ❖ PLEXI - FOLYO - DEKOTE - POLYCARBON - KOMPOZİT VB.

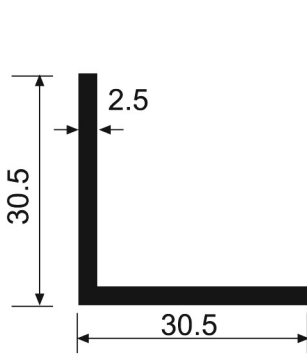

341

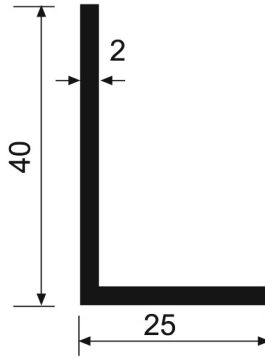

342

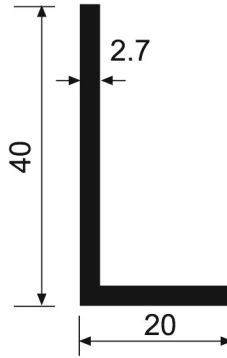

343

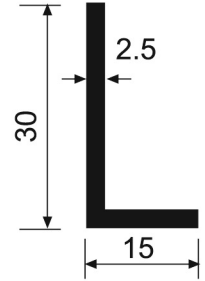

346

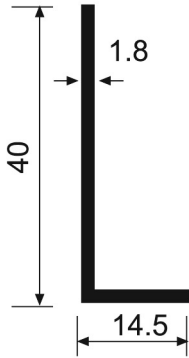

344

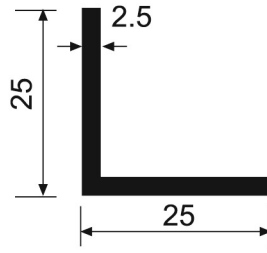

347

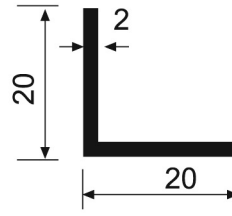

348

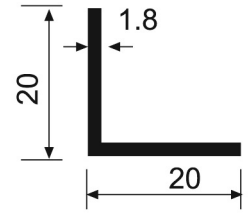

350

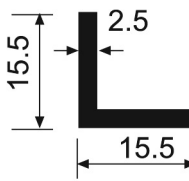

351

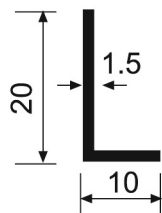

352

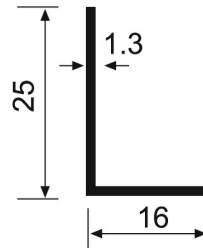

353

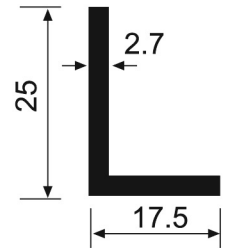

462

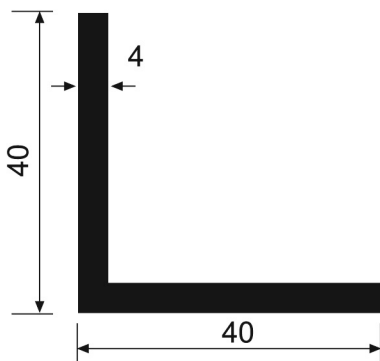

522

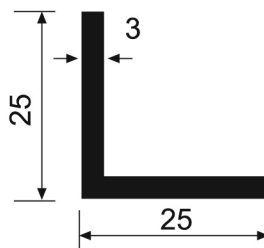

605

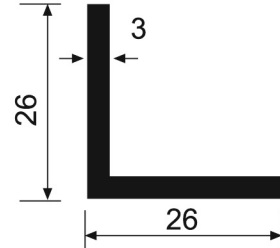

625



OSMANLI
ALÜMİNYUM SAN. ve TİC. LTD. ŞTİ.

- ❖ ÖZEL EBATLARDA BORU, KUTU, LAMA, KÖŞEBENT ÇEŞİTLERİ
- ❖ AYDINLATMA ve REKLAM PROFİLLERİ
- ❖ SOĞUTUCU ve LED PROFİLLERİ
- ❖ MOBİLYA ve SANAYİ PROFİLLERİ
- ❖ ÖZEL KALIP ÇİZİMLERİ ve İMALATI
- ❖ ELOKSALLI ve PRES PLAKA LEVHALARI
- ❖ GOFRAJLI ve DÜZ PARLAK RULO LEVHALARI
- ❖ LEVHA KESİM - BÜKÜM (ÖZEL ÖLÇÜLERİNİZDE)
- ❖ DELİKLİ ve DEKORATİF TELLER
- ❖ PLEXI - FOLYO - DEKOTE - POLYCARBON - KOMPOZİT VB.

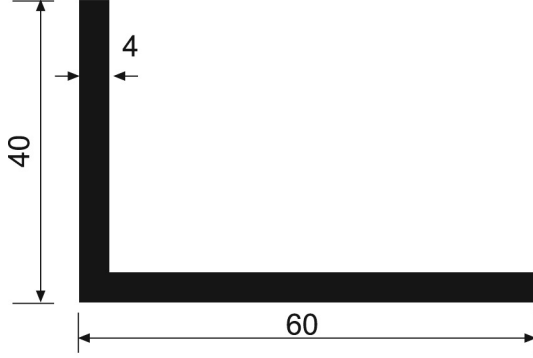

240

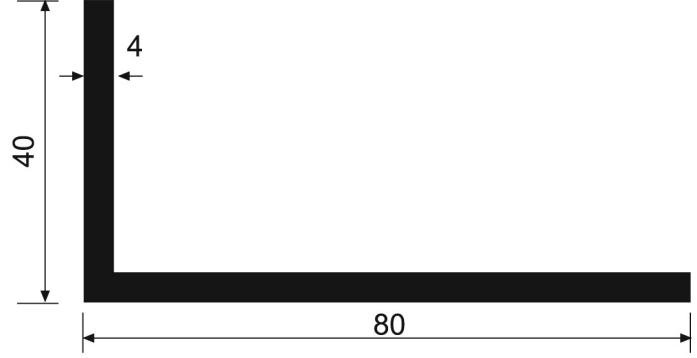

241

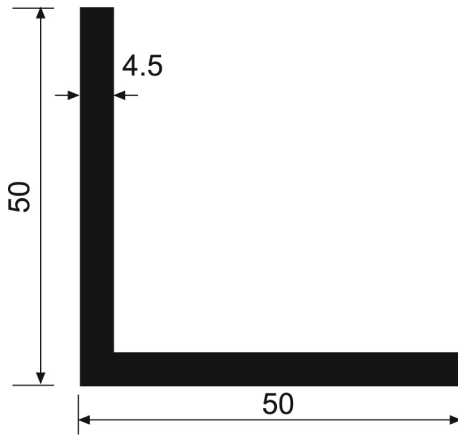

335

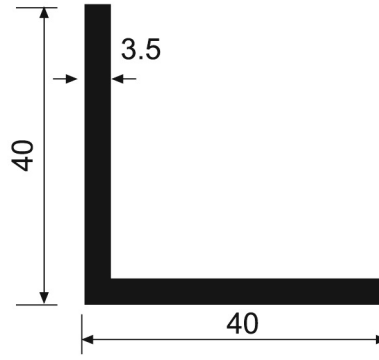

336

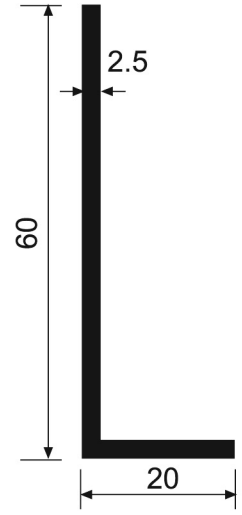

337

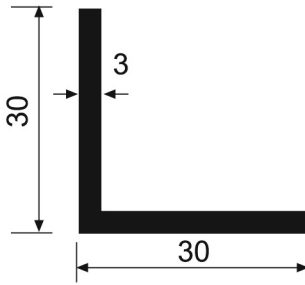

338

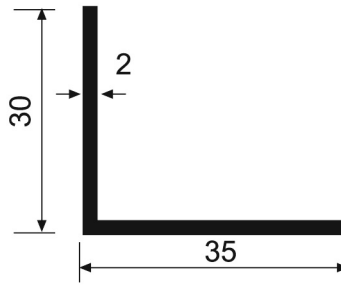

339

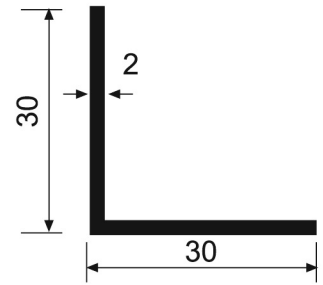

340

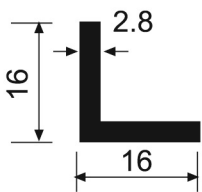

356

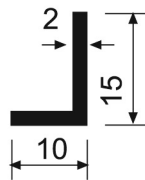

357

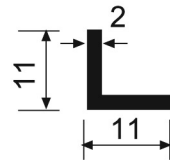

358

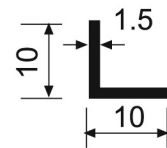

1451



OSMANLI
ALÜMİNYUM SAN. ve TİC. LTD .ŞTİ.

- ❖ ÖZEL EBATLARDA BORU, KUTU, LAMA, KÖŞEBENT ÇEŞİTLERİ
- ❖ AYDINLATMA ve REKLAM PROFİLLERİ
- ❖ SOĞUTUCU ve LED PROFİLLERİ
- ❖ MOBİLYA ve SANAYİ PROFİLLERİ
- ❖ ÖZEL KALIP ÇİZİMLERİ ve İMALATI
- ❖ ELOKSALLI ve PRES PLAKA LEVHALARI
- ❖ GOFRAJLI ve DÜZ PARLAK RULO LEVHALARI
- ❖ LEVHA KESİM - BÜKÜM (ÖZEL ÖLÇÜLERİNİZDE)
- ❖ DELİKLİ ve DEKORATİF TELLER
- ❖ PLEXI - FOLYO - DEKOTE - POLYCARBON - KOMPOZİT VB.

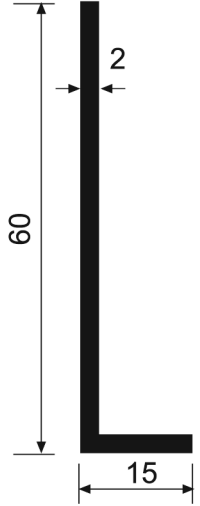

583

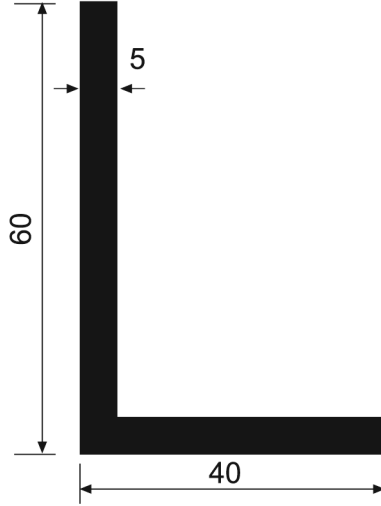

518

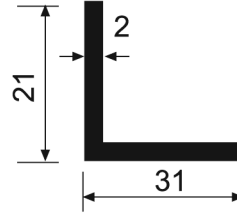

641

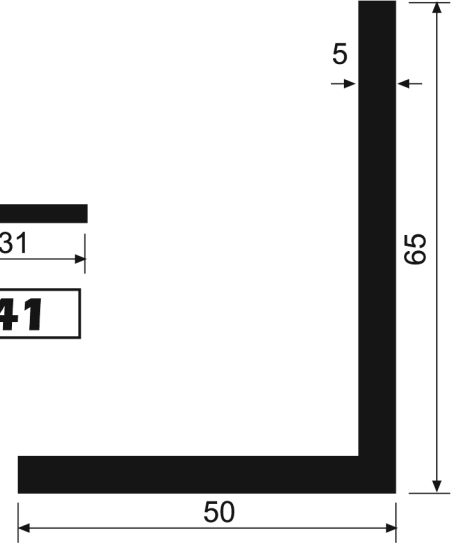

617

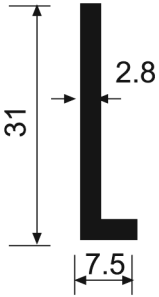

629

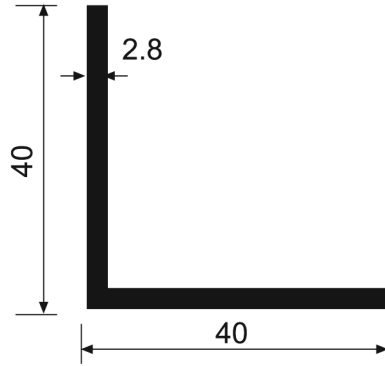

787

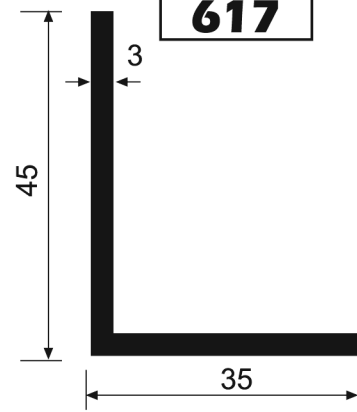

837

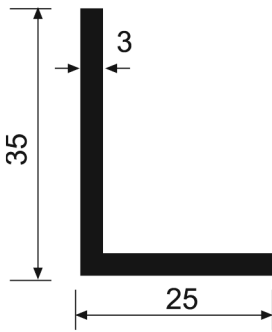

1344

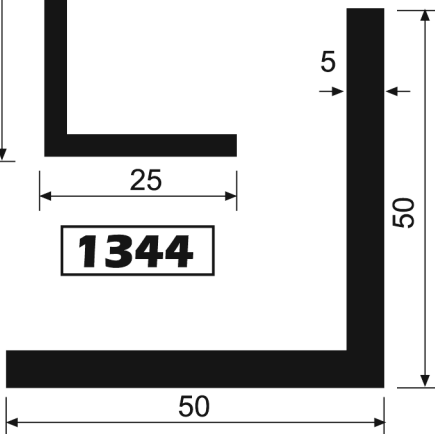

847

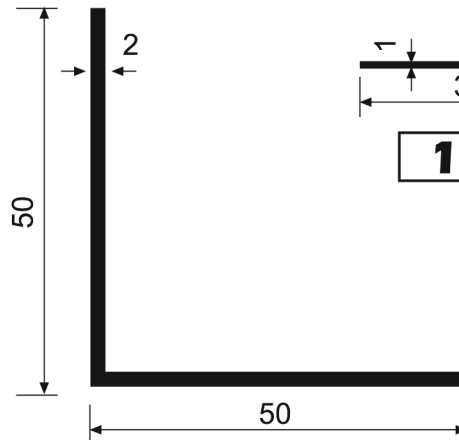

852

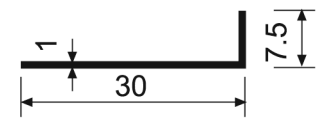

1028



OSMANLI
ALÜMİNYUM SAN. ve TİC. LTD. ŞTİ.

- ❖ ÖZEL EBATLARDA BORU, KUTU, LAMA, KÖŞEBENT ÇEŞİTLERİ
- ❖ AYDINLATMA ve REKLAM PROFİLLERİ
- ❖ SOĞUTUCU ve LED PROFİLLERİ
- ❖ MOBİLYA ve SANAYİ PROFİLLERİ
- ❖ ÖZEL KALIP ÇİZİMLERİ ve İMALATI
- ❖ ELOKSALLI ve PRES PLAKA LEVHALARI
- ❖ GOFRAJLI ve DÜZ PARLAK RULO LEVHALARI
- ❖ LEVHA KESİM - BÜKÜM (ÖZEL ÖLÇÜLERİNİZDE)
- ❖ DELİKLİ ve DEKORATİF TELLER
- ❖ PLEXI - FOLYO - DEKOTE - POLYCARBON - KOMPOZİT VB.

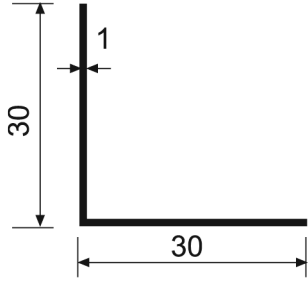

1845

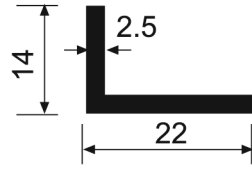

1846

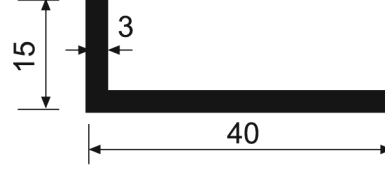

1848

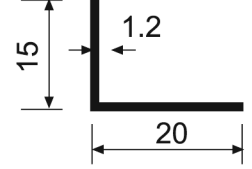

1849

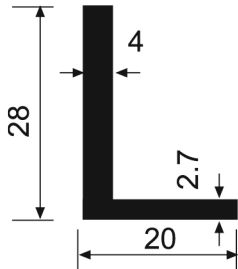

1851

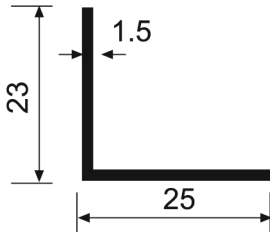

1852

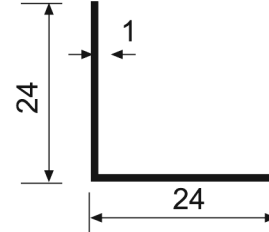

1853

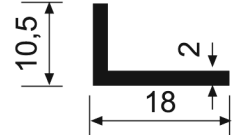

1854

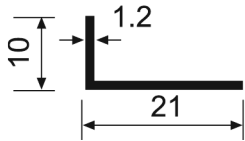

1855

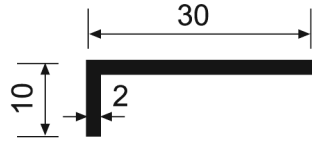

1856

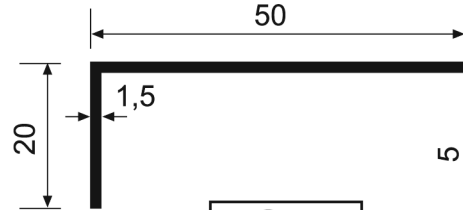

1857

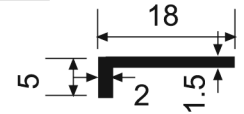

1862

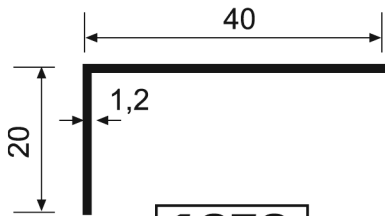

1858

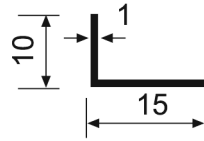

1859

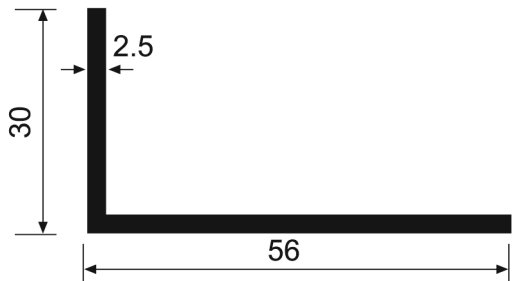

1860

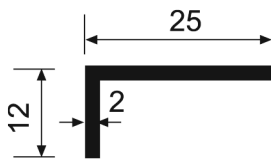

1864

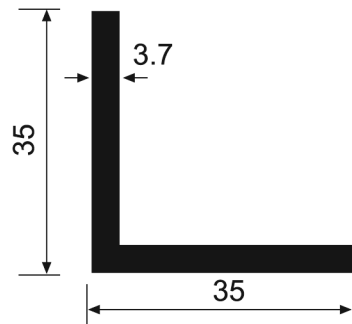

1861

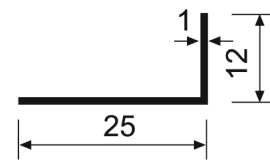

1865



OSMANLI
ALÜMİNYUM SAN. ve TİC. LTD. ŞTİ.

- ❖ ÖZEL EBATLARDA BORU, KUTU, LAMA, KÖŞEBENT ÇEŞİTLERİ
- ❖ AYDINLATMA ve REKLAM PROFİLLERİ
- ❖ SOĞUTUCU ve LED PROFİLLERİ
- ❖ MOBİLYA ve SANAYİ PROFİLLERİ
- ❖ ÖZEL KALIP ÇİZİMLERİ ve İMALATI
- ❖ ELOKSALLI ve PRES PLAKA LEVHALARI
- ❖ GOFRAJLI ve DÜZ PARLAK RULO LEVHALARI
- ❖ LEVHA KESİM - BÜKÜM (ÖZEL ÖLÇÜLERİNİZDE)
- ❖ DELİKLİ ve DEKORATİF TELLER
- ❖ PLEXI - FOLYO - DEKOTE - POLYCARBON - KOMPOZİT VB.

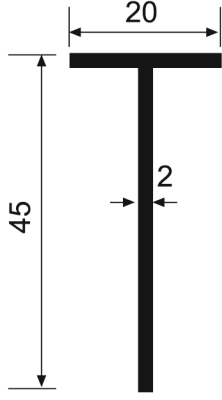

60

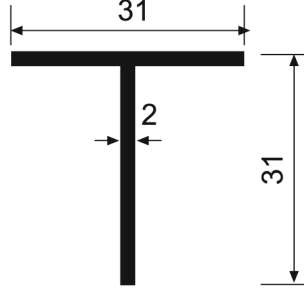

61

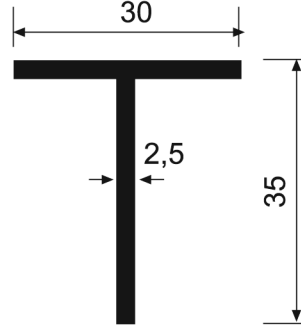

62

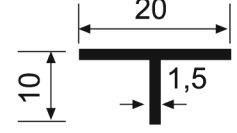

995

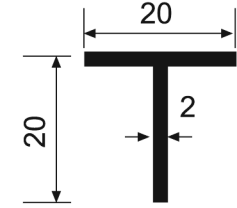

66

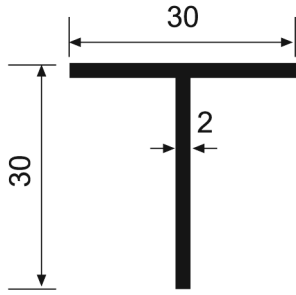

63

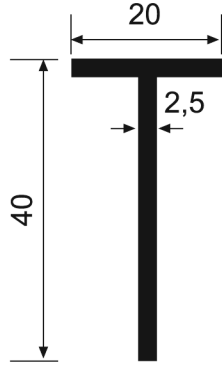

64

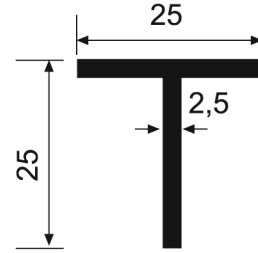

65

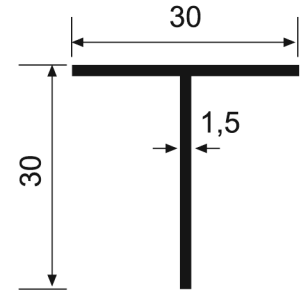

448

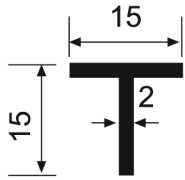

686

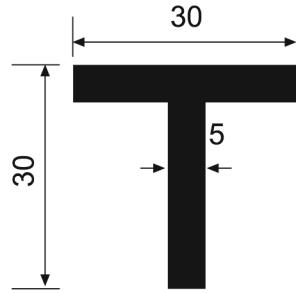

593

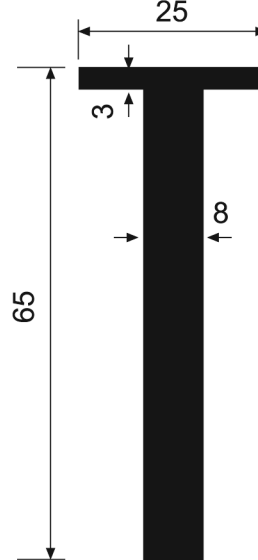

1650

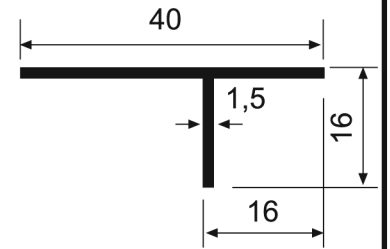

994

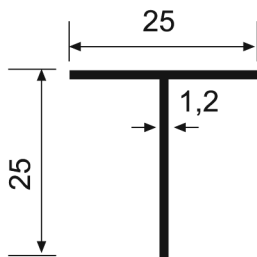

997

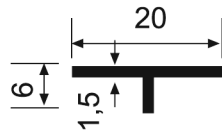

1569

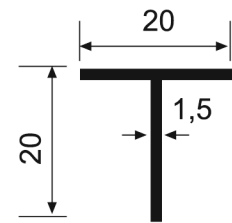

1047



OSMANLI
ALÜMİNYUM SAN. ve TİC. LTD. ŞTİ.

- ❖ ÖZEL EBATLARDA BORU, KUTU, LAMA, KÖŞEBENT ÇEŞİTLERİ
- ❖ AYDINLATMA ve REKLAM PROFİLLERİ
- ❖ SOĞUTUCU ve LED PROFİLLERİ
- ❖ MOBİLYA ve SANAYİ PROFİLLERİ
- ❖ ÖZEL KALIP ÇİZİMLERİ ve İMALATI
- ❖ ELOKSALLI ve PRES PLAKA LEVHALARI
- ❖ GOFRAJLI ve DÜZ PARLAK RULO LEVHALARI
- ❖ LEVHA KESİM - BÜKÜM (ÖZEL ÖLÇÜLERİNİZDE)
- ❖ DELİKLİ ve DEKORATİF TELLER
- ❖ PLEXI - FOLYO - DEKOTE - POLYCARBON - KOMPOZİT VB.

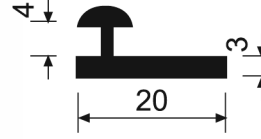
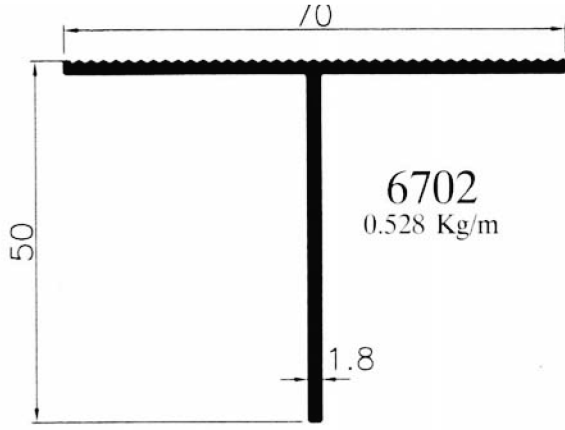

(0,225 Kg/m)

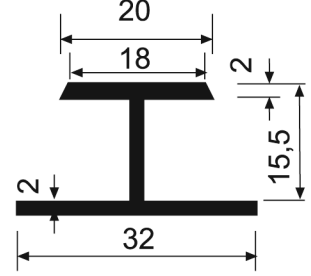

(0,360 Kg/m)

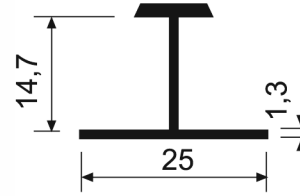
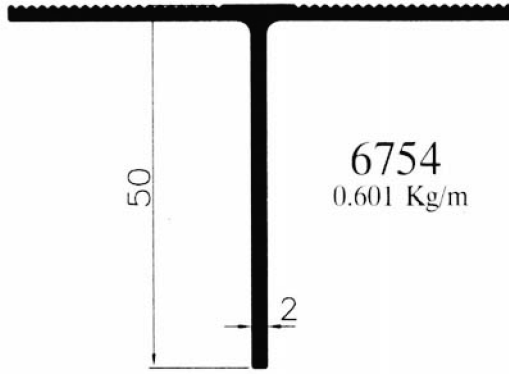

(0,210 Kg/m)

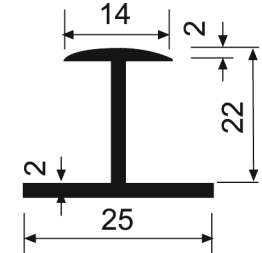

(0,285 Kg/m)

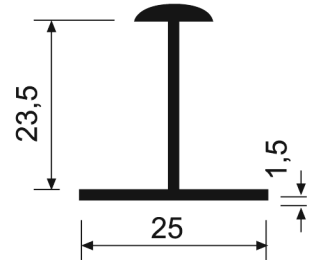
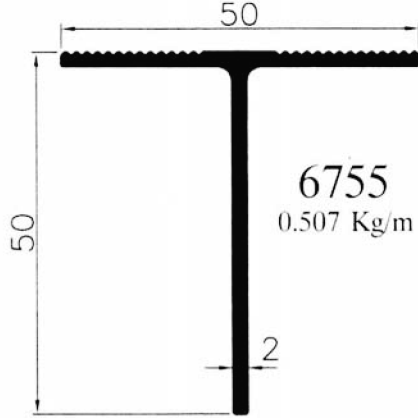

(0,250 Kg/m)

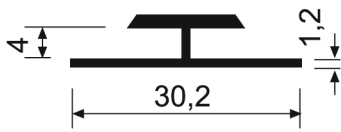

(0,176 Kg/m)

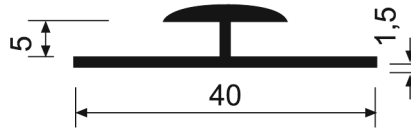

(0,255 Kg/m)

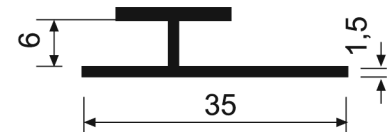

(0,240 Kg/m)



OSMANLI
ALÜMİNYUM SAN. ve TİC. LTD .ŞTİ.

- ❖ ÖZEL EBATLARDA BORU, KUTU, LAMA, KÖŞEBENT ÇEŞİTLERİ
- ❖ AYDINLATMA ve REKLAM PROFİLLERİ
- ❖ SOĞUTUCU ve LED PROFİLLERİ
- ❖ MOBİLYA ve SANAYİ PROFİLLERİ
- ❖ ÖZEL KALIP ÇİZİMLERİ ve İMALATI
- ❖ ELOKSALLI ve PRES PLAKA LEVHALARI
- ❖ GOFRAJLI ve DÜZ PARLAK RULO LEVHALARI
- ❖ LEVHA KESİM - BÜKÜM (ÖZEL ÖLÇÜLERİNİZDE)
- ❖ DELİKLİ ve DEKORATİF TELLER
- ❖ PLEXI - FOLYO - DEKOTE - POLYCARBON - KOMPOZİT VB.

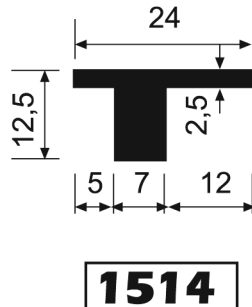
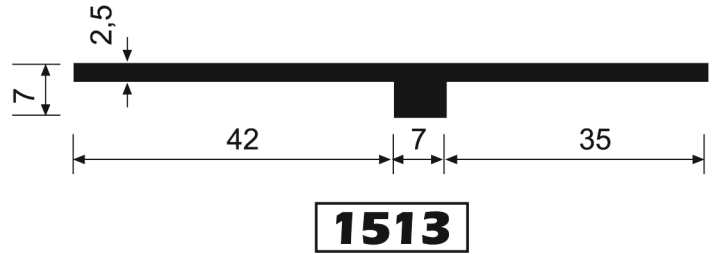
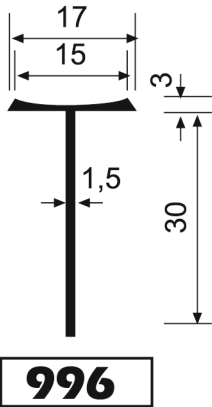
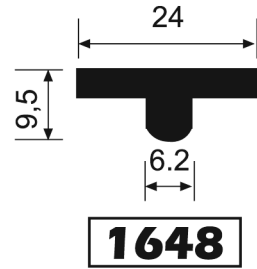
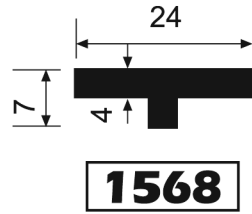
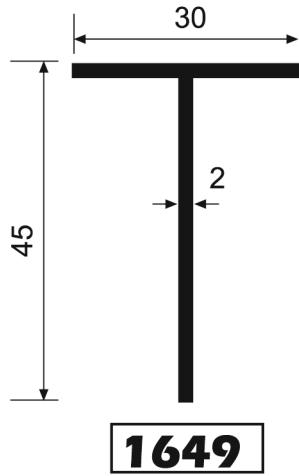
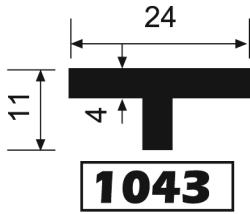
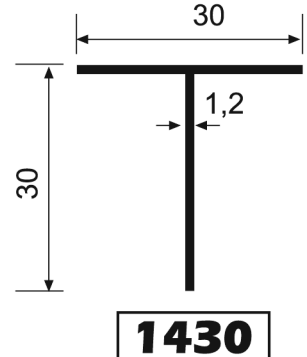
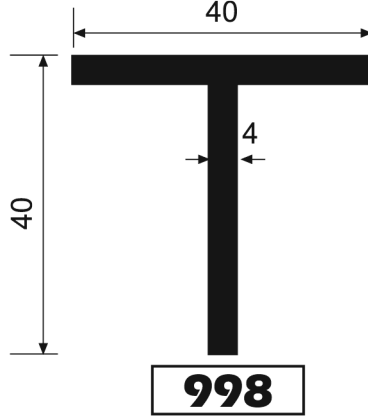
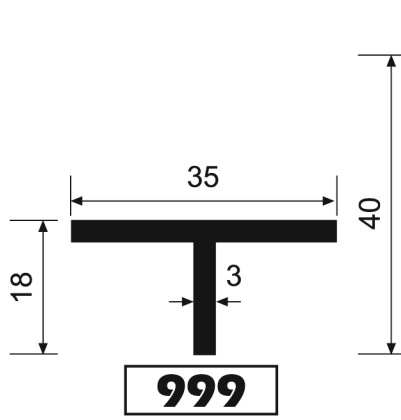
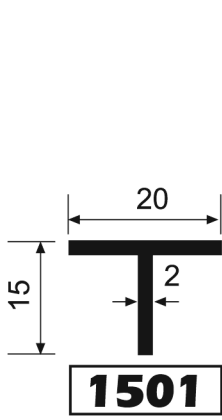



OSMANLI
ALÜMİNYUM SAN. ve TİC. LTD .ŞTİ.

- ❖ ÖZEL EBATLARDA BORU, KUTU, LAMA, KÖŞEBENT ÇEŞİTLERİ
- ❖ AYDINLATMA ve REKLAM PROFİLLERİ
- ❖ SOĞUTUCU ve LED PROFİLLERİ
- ❖ MOBİLYA ve SANAYİ PROFİLLERİ
- ❖ ÖZEL KALIP ÇİZİMLERİ ve İMALATI
- ❖ ELOKSALLI ve PRES PLAKA LEVHALARI
- ❖ GOFRAJLI ve DÜZ PARLAK RULO LEVHALARI
- ❖ LEVHA KESİM - BÜKÜM (ÖZEL ÖLÇÜLERİNİZDE)
- ❖ DELİKLİ ve DEKORATİF TELLER
- ❖ PLEXI - FOLYO - DEKOTE - POLYCARBON - KOMPOZİT VB.

DERZ PROFİLLERİ

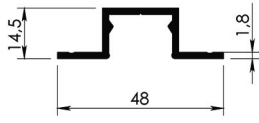

4482 - 0,371 kg/m

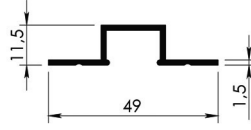

5061 - 0,285 kg/m

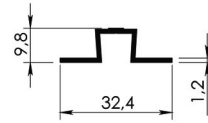

3078 - 0,168 kg/m



5204 - 0,344 kg/m

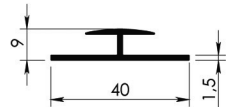

5959 - 0,250 kg/m

ASKI PROFİLLERİ

5014
0,212 kg/m

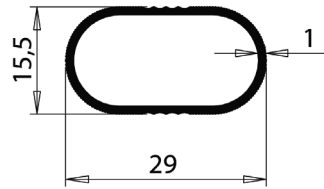

130
0,155 kg/m

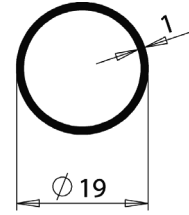

4829
0,240 kg/m

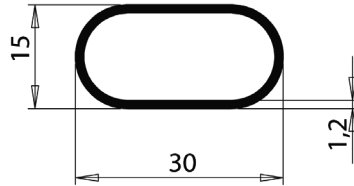

121
0,076 kg/m

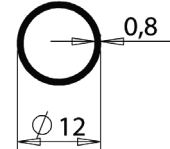

4806
0,186 kg/m

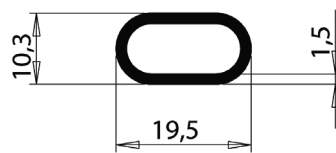

5187
0,179 kg/m

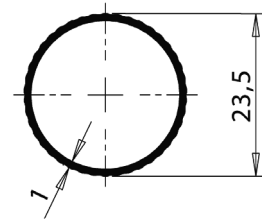

6921
0,130 kg/m

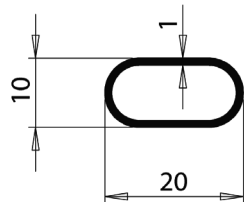

5013
0,209 kg/m

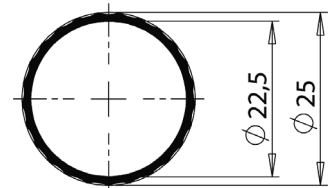



OSMANLI
ALÜMİNYUM SAN. ve TİC. LTD. ŞTİ.

- ❖ ÖZEL EBATLARDA BORU, KUTU, LAMA, KÖŞEBENT ÇEŞİTLERİ
- ❖ AYDINLATMA ve REKLAM PROFİLLERİ
- ❖ SOĞUTUCU ve LED PROFİLLERİ
- ❖ MOBİLYA ve SANAYİ PROFİLLERİ
- ❖ ÖZEL KALIP ÇİZİMLERİ ve İMALATI
- ❖ ELOKSALLI ve PRES PLAKA LEVHALARI
- ❖ GOFRAJLI ve DÜZ PARLAK RULO LEVHALARI
- ❖ LEVHA KESİM - BÜKÜM (ÖZEL ÖLÇÜLERİNİZDE)
- ❖ DELİKLİ ve DEKORATİF TELLER
- ❖ PLEXI - FOLYO - DEKOTE - POLYCARBON - KOMPOZİT VB.

SİNEKLİK PROFİLLERİ

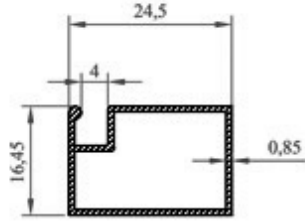

Profil N o : 2501
Ag ırık : 0,198 kg/m

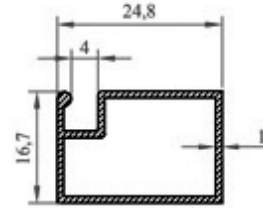

Profil N o : 2502
Ag ırık : 0,235 kg/m

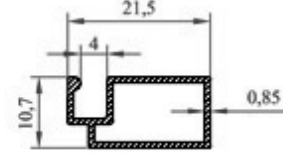

Profil N o : 2503
Ag ırık : 0,152 kg/m

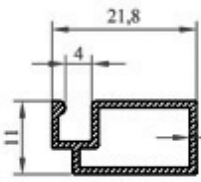

Profil N o : 2504
Ag ırık : 0,179 kg/m

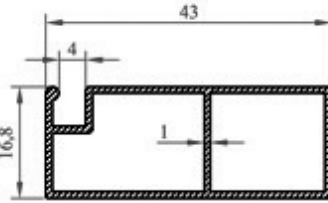

Profil N o : 2505
Ag ırık : 0,373 kg/m

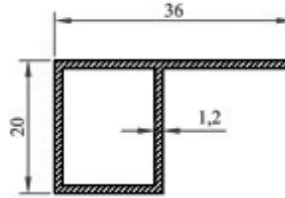

Profil N o : 2506
Ag ırık : 0,284 kg/m

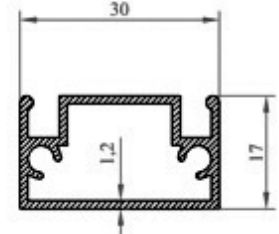

Profil N o : 5138
Ag ırık : 0,369 kg/m

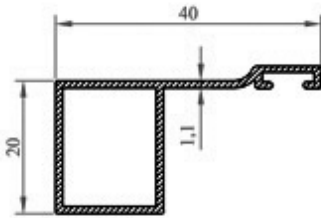

Profil N o : 2507
Ag ırık : 0,295 kg/m

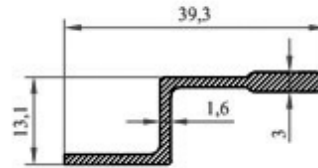

Profil N o : 2508
Ag ırık : 0,256 kg/m

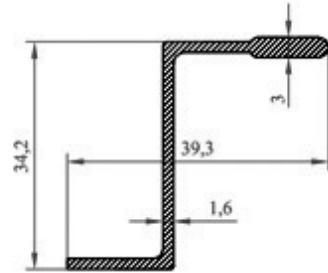

Profil N o : 2509
Ag ırık : 0,355 kg/m

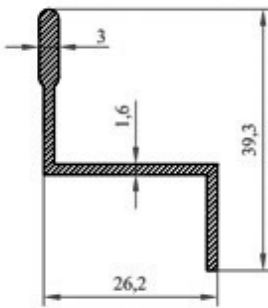

Profil N o : 2510
Ag ırık : 0,317 kg/m

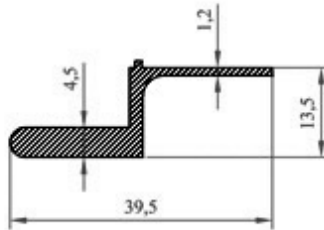

Profil N o : 2511
Ag ırık : 0,358 kg/m

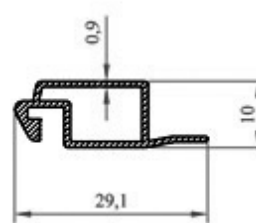

Profil N o : 2512
Ag ırık : 0,180 kg/m

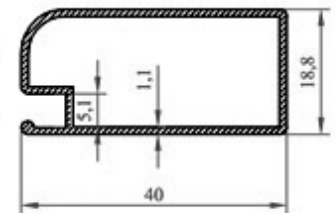

Profil N o : 2513
Ag ırık : 0,347 kg/m



OSMANLI
ALÜMİNYUM SAN. ve TİC. LTD. ŞTİ.

- ❖ ÖZEL EBATLARDA BORU, KUTU, LAMA, KÖŞEBENT ÇEŞİTLERİ
- ❖ AYDINLATMA ve REKLAM PROFİLLERİ
- ❖ SOĞUTUCU ve LED PROFİLLERİ
- ❖ MOBİLYA ve SANAYİ PROFİLLERİ
- ❖ ÖZEL KALIP ÇİZİMLERİ ve İMALATI
- ❖ ELOKSALLI ve PRES PLAKA LEVHALARI
- ❖ GOFRAJLI ve DÜZ PARLAK RULO LEVHALARI
- ❖ LEVHA KESİM - BÜKÜM (ÖZEL ÖLÇÜLERİNİZDE)
- ❖ DELİKLİ ve DEKORATİF TELLER
- ❖ PLEXI - FOLYO - DEKOTE - POLYCARBON - KOMPOZİT VB.

DENİZLİK PROFİLLERİ

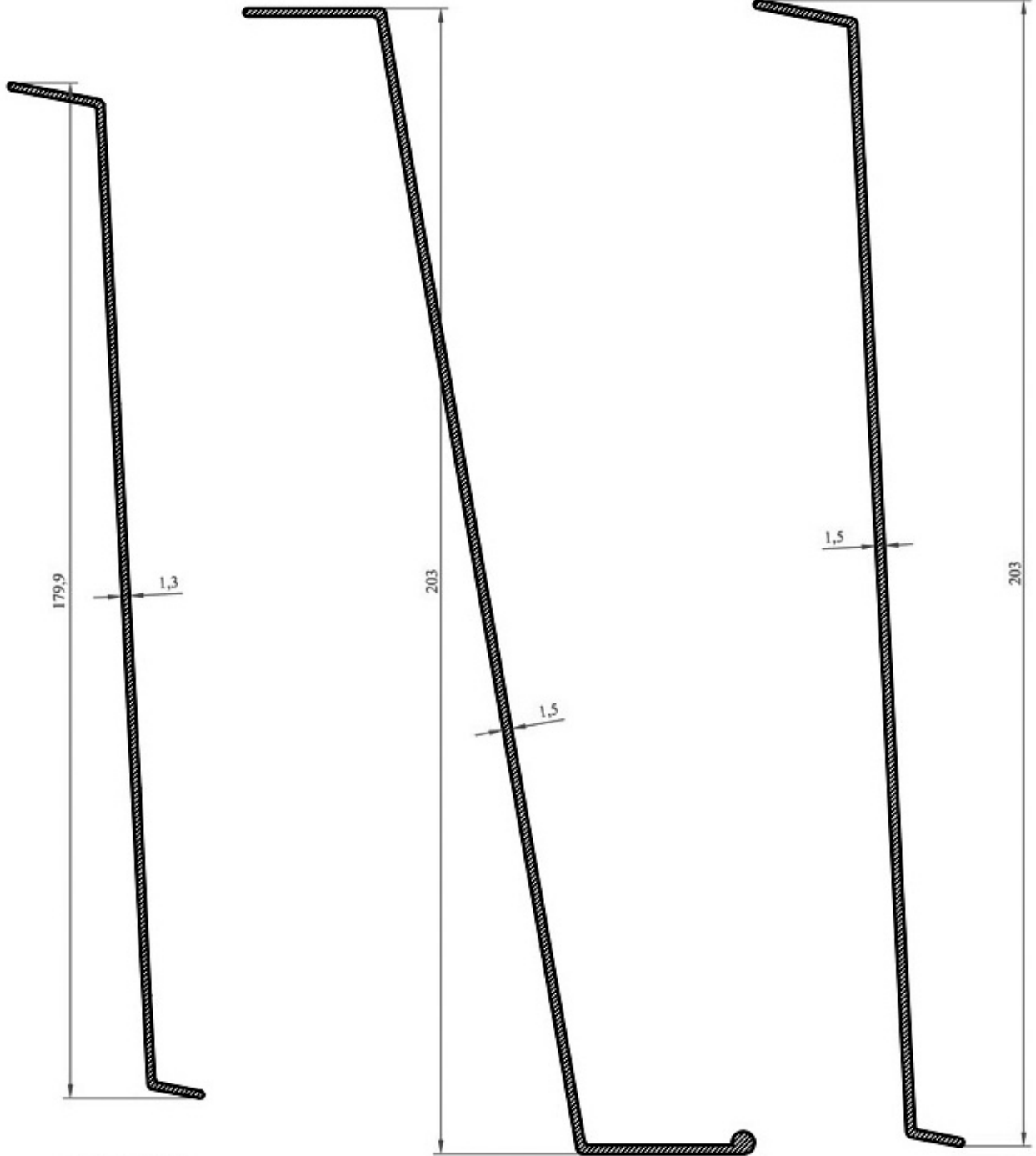



OSMANLI
ALÜMİNYUM SAN. ve TİC. LTD. ŞTİ.

- ❖ ÖZEL EBATLARDA BORU, KUTU, LAMA, KÖŞEBENT ÇEŞİTLERİ
- ❖ AYDINLATMA ve REKLAM PROFİLLERİ
- ❖ SOĞUTUCU ve LED PROFİLLERİ
- ❖ MOBİLYA ve SANAYİ PROFİLLERİ
- ❖ ÖZEL KALIP ÇİZİMLERİ ve İMALATI
- ❖ ELOKSALLI ve PRES PLAKA LEVHALARI
- ❖ GOFRAJLI ve DÜZ PARLAK RULO LEVHALARI
- ❖ LEVHA KESİM - BÜKÜM (ÖZEL ÖLÇÜLERİNİZDE)
- ❖ DELİKLİ ve DEKORATİF TELLER
- ❖ PLEXI - FOLYO - DEKOTE - POLYCARBON - KOMPOZİT VB.

DENİZLİK PROFİLLERİ

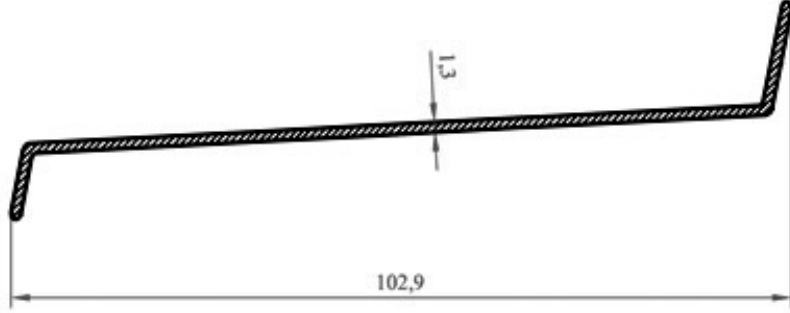

Profil No : 3152
Ag ırık : 0,426 kg/m

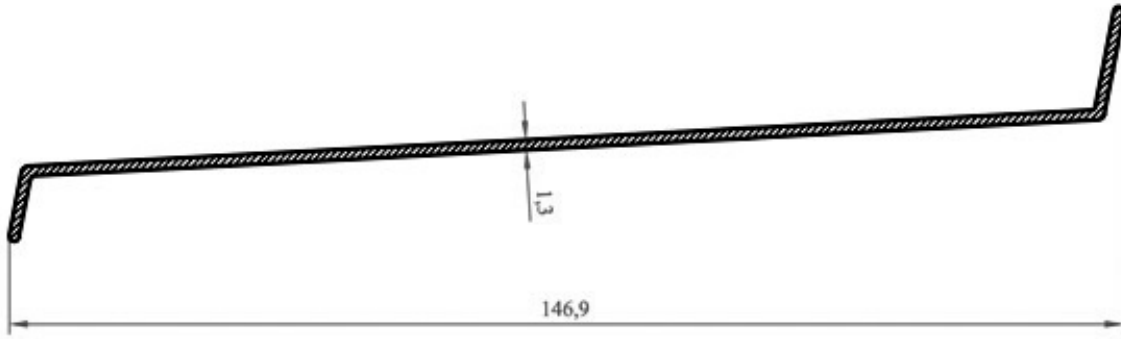

Profil No : 3153
Ag ırık : 0,582 kg/m

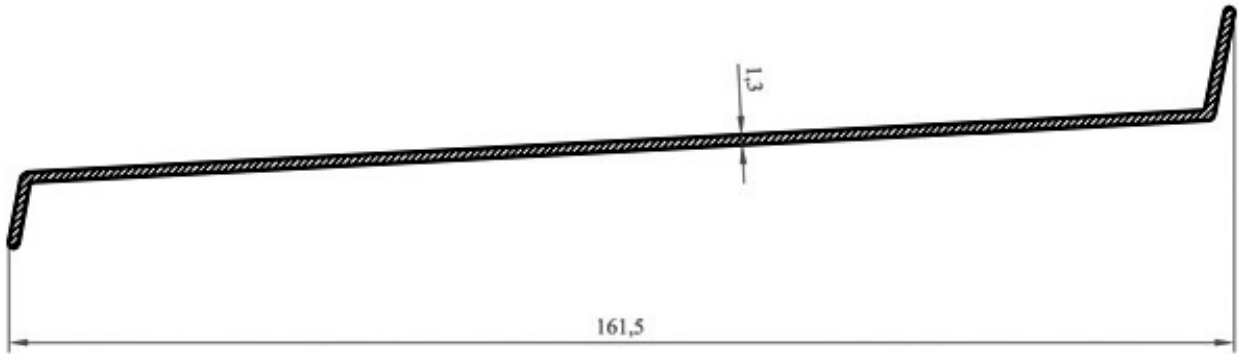

Profil No : 3151
Ag ırık : 0,633 kg/m



OSMANLI
ALÜMİNYUM SAN. ve TİC. LTD .ŞTİ.

- ❖ ÖZEL EBATLARDA BORU, KUTU, LAMA, KÖŞEBENT ÇEŞİTLERİ
- ❖ AYDINLATMA ve REKLAM PROFİLLERİ
- ❖ SOĞUTUCU ve LED PROFİLLERİ
- ❖ MOBİLYA ve SANAYİ PROFİLLERİ
- ❖ ÖZEL KALIP ÇİZİMLERİ ve İMALATI
- ❖ ELOKSALLI ve PRES PLAKA LEVHALARI
- ❖ GOFRAJLI ve DÜZ PARLAK RULO LEVHALARI
- ❖ LEVHA KESİM - BÜKÜM (ÖZEL ÖLÇÜLERİNİZDE)
- ❖ DELİKLİ ve DEKORATİF TELLER
- ❖ PLEXI - FOLYO - DEKOTE - POLYCARBON - KOMPOZİT VB.

KÖŞEBENT PROFİLLER

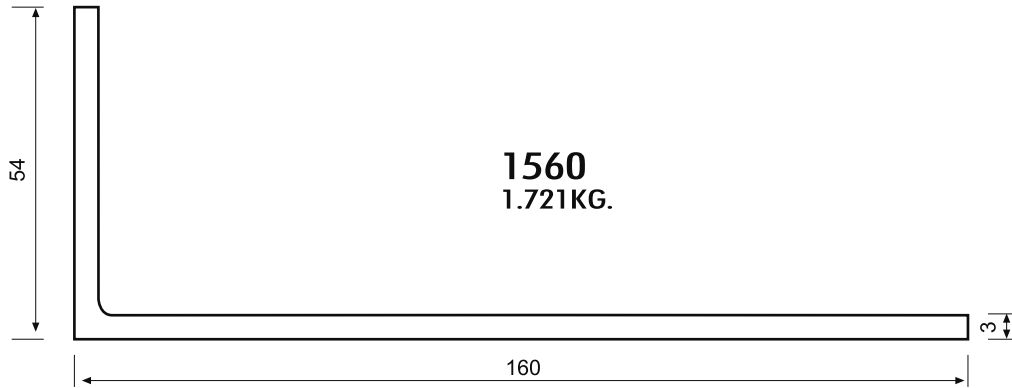
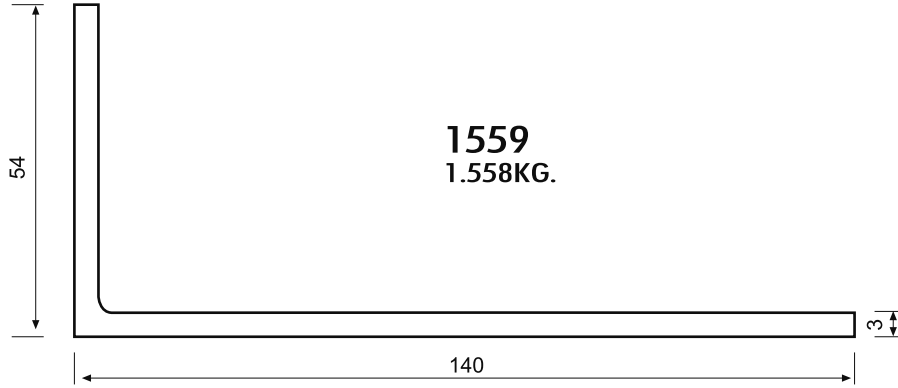
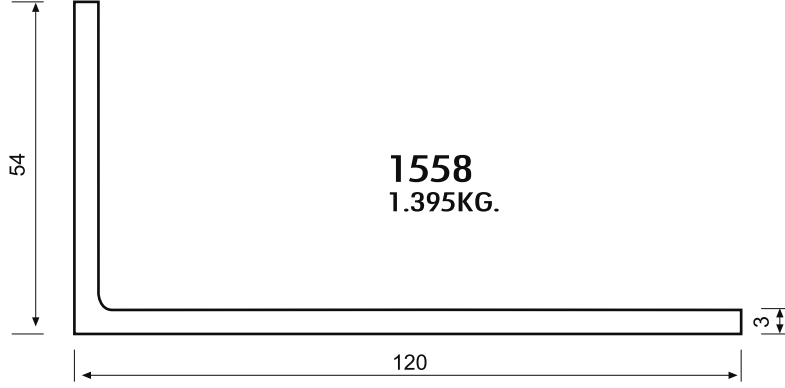



OSMANLI
ALÜMİNYUM SAN. ve TİC. LTD. ŞTİ.

- ❖ ÖZEL EBATLARDA BORU, KUTU, LAMA, KÖŞEBENT ÇEŞİTLERİ
- ❖ AYDINLATMA ve REKLAM PROFİLLERİ
- ❖ SOĞUTUCU ve LED PROFİLLERİ
- ❖ MOBİLYA ve SANAYİ PROFİLLERİ
- ❖ ÖZEL KALIP ÇİZİMLERİ ve İMALATI
- ❖ ELOKSALLI ve PRES PLAKA LEVHALARI
- ❖ GOFRAJLI ve DÜZ PARLAK RULO LEVHALARI
- ❖ LEVHA KESİM - BÜKÜM (ÖZEL ÖLÇÜLERİNİZDE)
- ❖ DELİKLİ ve DEKORATİF TELLER
- ❖ PLEXI - FOLYO - DEKOTE - POLYCARBON - KOMPOZİT VB.

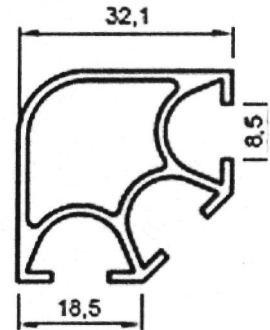
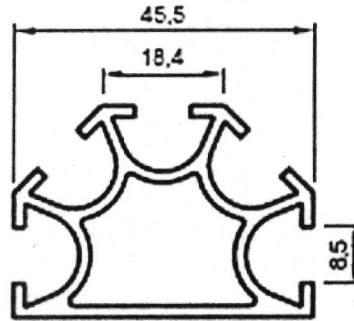
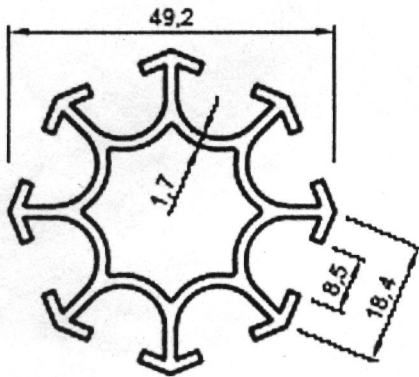
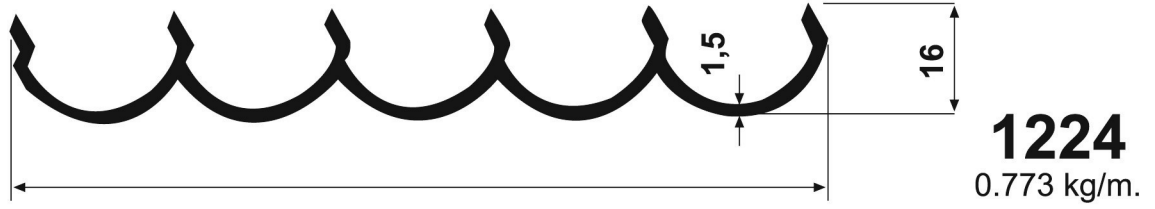
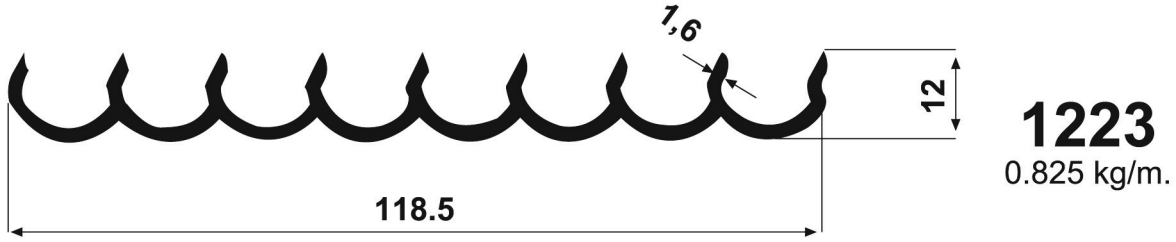
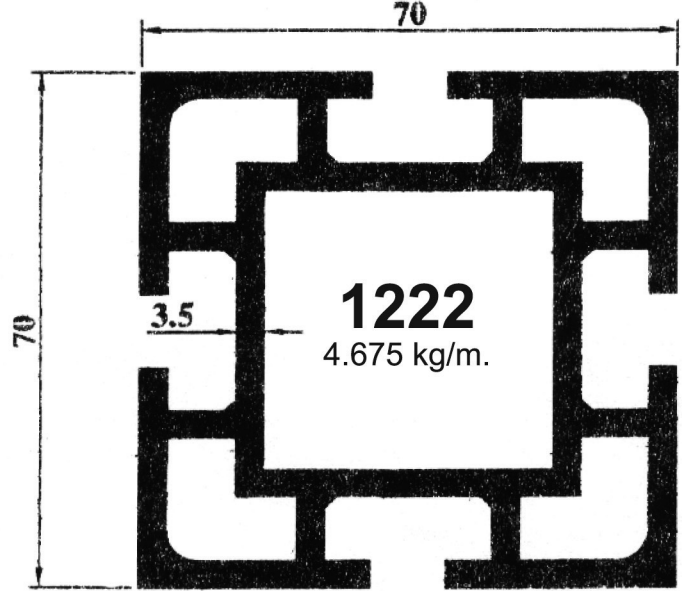
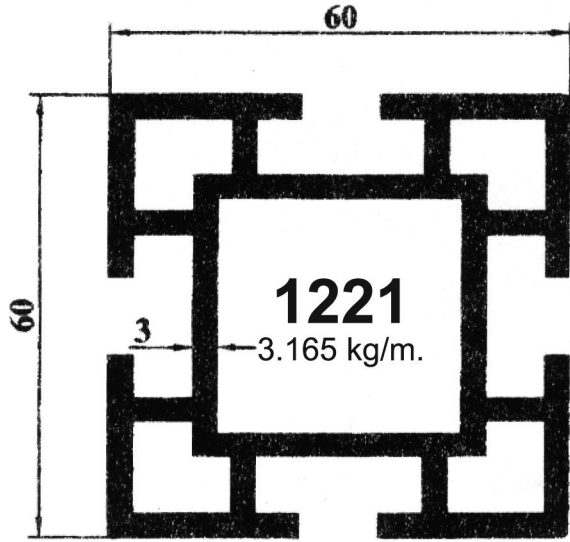

1225
Dikme
1.100 kg/m.

1226
Dikme
0.900 kg/m.

1227
Dikme
0.605 kg/m.



OSMANLI
ALÜMİNYUM SAN. ve TİC. LTD .ŞTİ.

- ❖ ÖZEL EBATLARDA BORU, KUTU, LAMA, KÖŞEBENT ÇEŞİTLERİ
- ❖ AYDINLATMA ve REKLAM PROFİLLERİ
- ❖ SOĞUTUCU ve LED PROFİLLERİ
- ❖ MOBİLYA ve SANAYİ PROFİLLERİ
- ❖ ÖZEL KALIP ÇİZİMLERİ ve İMALATI
- ❖ ELOKSALLI ve PRES PLAKA LEVHALARI
- ❖ GOFRAJLI ve DÜZ PARLAK RULO LEVHALARI
- ❖ LEVHA KESİM - BÜKÜM (ÖZEL ÖLÇÜLERİNİZDE)
- ❖ DELİKLİ ve DEKORATİF TELLER
- ❖ PLEXI - FOLYO - DEKOTE - POLYCARBON - KOMPOZİT VB.

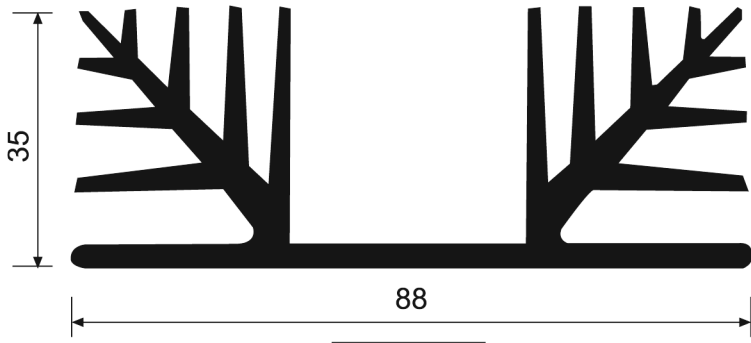

2057



2060

(0,595 Kg/m)

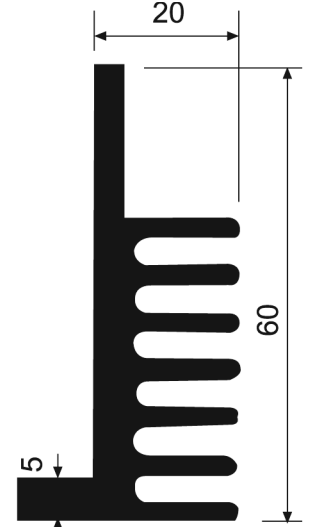

2061

(1,340 Kg/m)



2059

(3,292 Kg/m)

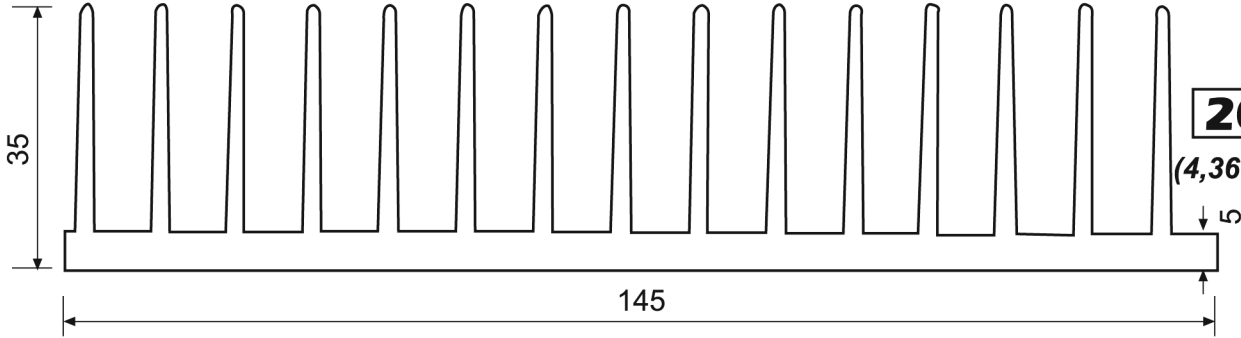

2063

(4,363 Kg/m)

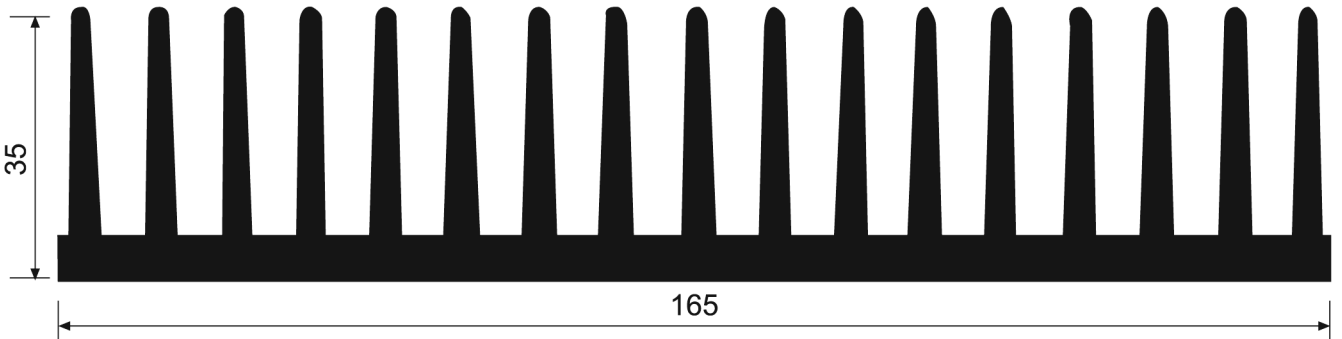

2064

(4,363 Kg/m)



OSMANLI
ALÜMİNYUM SAN. ve TİC. LTD. ŞTİ.

- ❖ ÖZEL EBATLARDA BORU, KUTU, LAMA, KÖŞEBENT ÇEŞİTLERİ
- ❖ AYDINLATMA ve REKLAM PROFİLLERİ
- ❖ SOĞUTUCU ve LED PROFİLLERİ
- ❖ MOBİLYA ve SANAYİ PROFİLLERİ
- ❖ ÖZEL KALIP ÇİZİMLERİ ve İMALATI
- ❖ ELOKSALLI ve PRES PLAKA LEVHALARI
- ❖ GOFRAJLI ve DÜZ PARLAK RULO LEVHALARI
- ❖ LEVHA KESİM - BÜKÜM (ÖZEL ÖLÇÜLERİNİZDE)
- ❖ DELİKLİ ve DEKORATİF TELLER
- ❖ PLEXI - FOLYO - DEKOTE - POLYCARBON - KOMPOZİT VB.

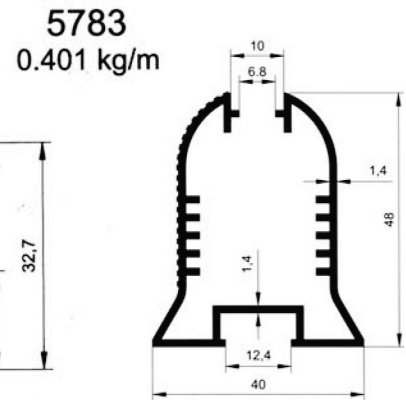
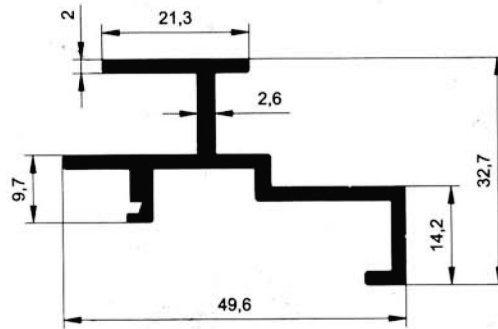
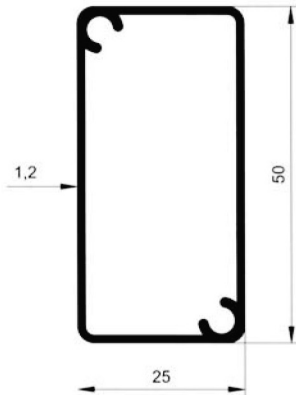
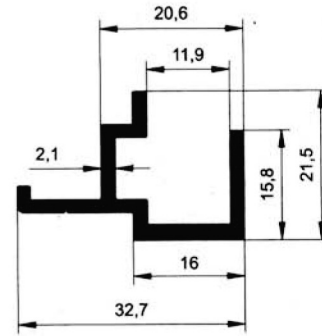
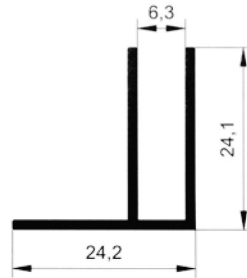
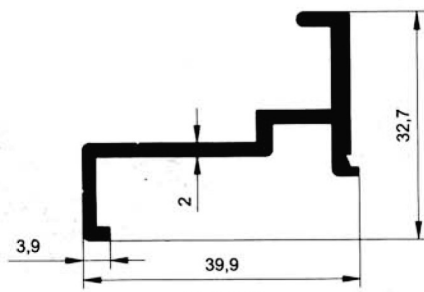
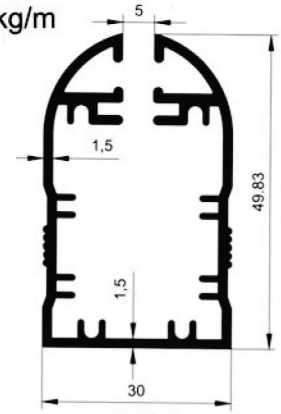
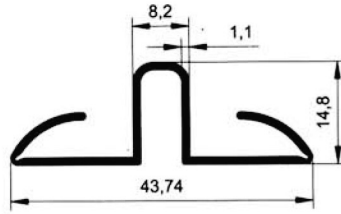
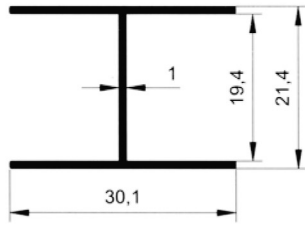
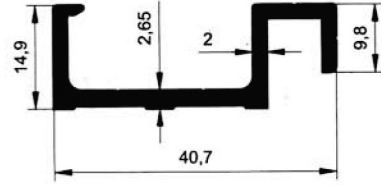
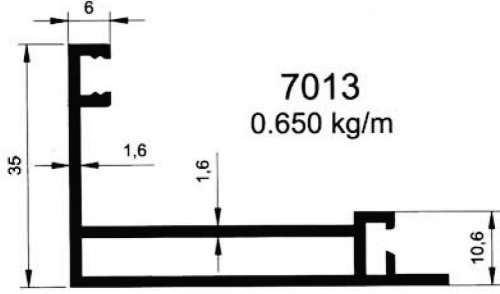



OSMANLI
ALÜMİNYUM SAN. ve TİC. LTD .ŞTİ.

- ❖ ÖZEL EBATLARDA BORU, KUTU, LAMA, KÖŞEBENT ÇEŞİTLERİ
- ❖ AYDINLATMA ve REKLAM PROFİLLERİ
- ❖ SOĞUTUCU ve LED PROFİLLERİ
- ❖ MOBİLYA ve SANAYİ PROFİLLERİ
- ❖ ÖZEL KALIP ÇİZİMLERİ ve İMALATI
- ❖ ELOKSALLI ve PRES PLAKA LEVHALARI
- ❖ GOFRAJLI ve DÜZ PARLAK RULO LEVHALARI
- ❖ LEVHA KESİM - BÜKÜM (ÖZEL ÖLÇÜLERİNİZDE)
- ❖ DELİKLİ ve DEKORATİF TELLER
- ❖ PLEXI - FOLYO - DEKOTE - POLYCARBON - KOMPOZİT VB.

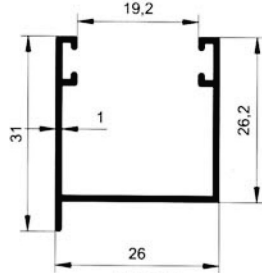

5122
0.256 kg/m

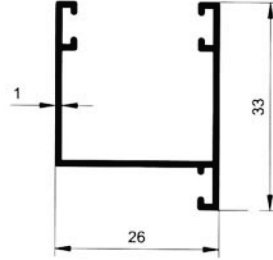

5123
0.274 kg/m

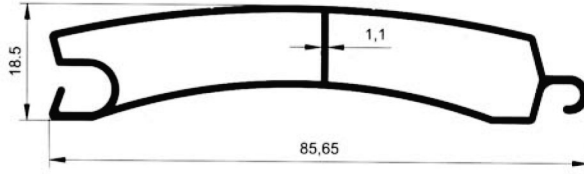

5394
0.653 kg/m

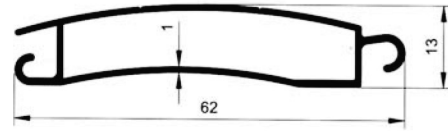

5395
0.405 kg/m

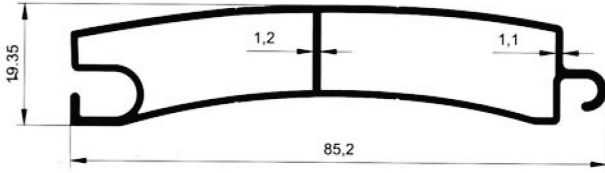

5610
0.656 kg/m

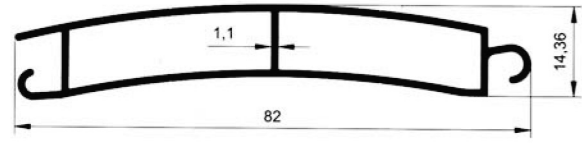

5611
0.577 kg/m

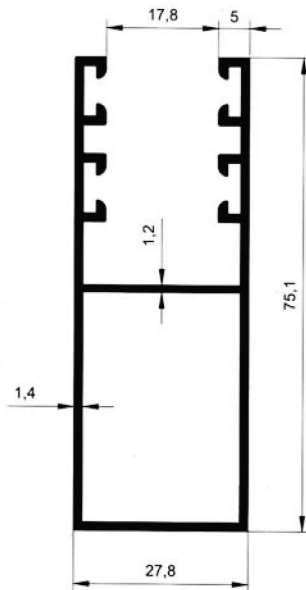

5621
0.918 kg/m

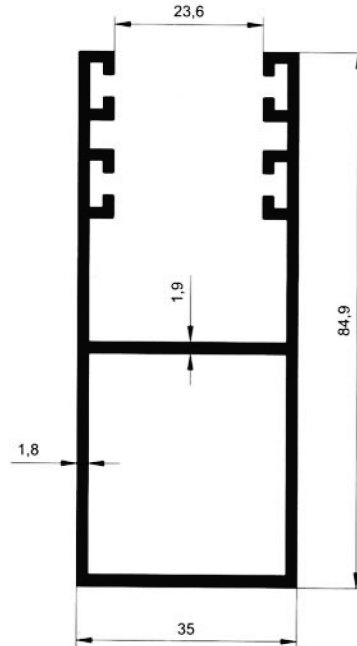

5622
1.389 kg/m



OSMANLI
ALÜMİNYUM SAN. ve TİC. LTD .ŞTİ.

- ❖ ÖZEL EBATLARDA BORU, KUTU, LAMA, KÖŞEBENT ÇEŞİTLERİ
- ❖ AYDINLATMA ve REKLAM PROFİLLERİ
- ❖ SOĞUTUCU ve LED PROFİLLERİ
- ❖ MOBİLYA ve SANAYİ PROFİLLERİ
- ❖ ÖZEL KALIP ÇİZİMLERİ ve İMALATI
- ❖ ELOKSALLI ve PRES PLAKA LEVHALARI
- ❖ GOFRAJLI ve DÜZ PARLAK RULO LEVHALARI
- ❖ LEVHA KESİM - BÜKÜM (ÖZEL ÖLÇÜLERİNİZDE)
- ❖ DELİKLİ ve DEKORATİF TELLER
- ❖ PLEXI - FOLYO - DEKOTE - POLYCARBON - KOMPOZİT VB.

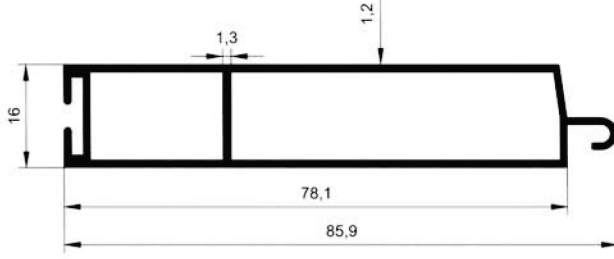

5620
0.713 kg/m

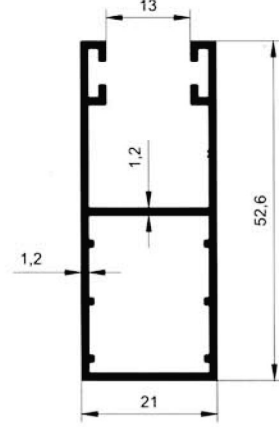

5749
0.542 kg/m

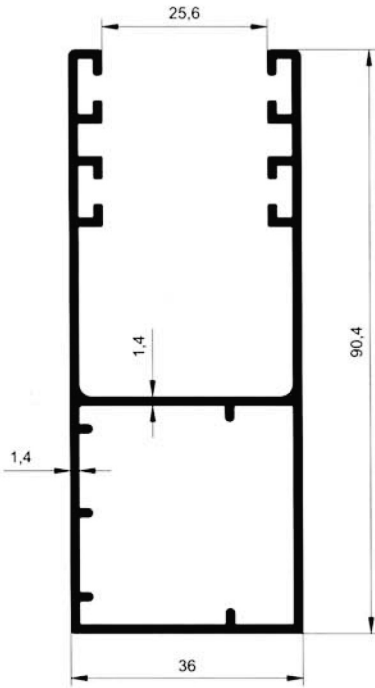

5750
1.166 kg/m

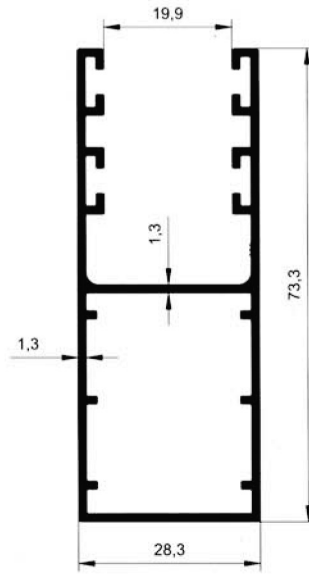

5751
0.876 kg/m

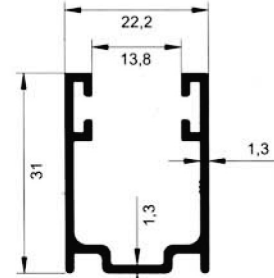

5752
0.383 kg/m

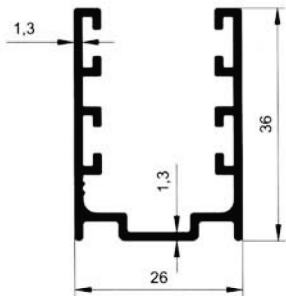

5753
0.383 kg/m

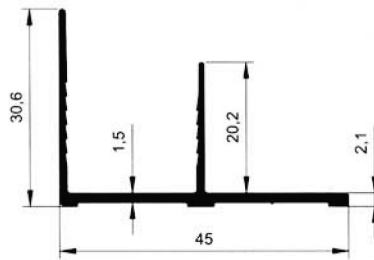

5764
0.339 kg/m

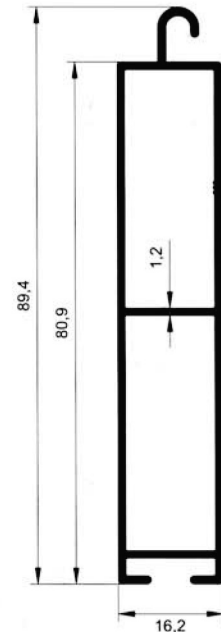

5754



OSMANLI
ALÜMİNYUM SAN. ve TİC. LTD .ŞTİ.

- ❖ ÖZEL EBATLARDA BORU, KUTU, LAMA, KÖŞEBENT ÇEŞİTLERİ
- ❖ AYDINLATMA ve REKLAM PROFİLLERİ
- ❖ SOĞUTUCU ve LED PROFİLLERİ
- ❖ MOBİLYA ve SANAYİ PROFİLLERİ
- ❖ ÖZEL KALIP ÇİZİMLERİ ve İMALATI
- ❖ ELOKSALLI ve PRES PLAKA LEVHALARI
- ❖ GOFRAJLI ve DÜZ PARLAK RULO LEVHALARI
- ❖ LEVHA KESİM - BÜKÜM (ÖZEL ÖLÇÜLERİNİZDE)
- ❖ DELİKLİ ve DEKORATİF TELLER
- ❖ PLEXI - FOLYO - DEKOTE - POLYCARBON - KOMPOZİT VB.

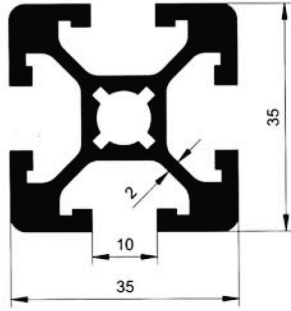

5354
0.1334 kg/m

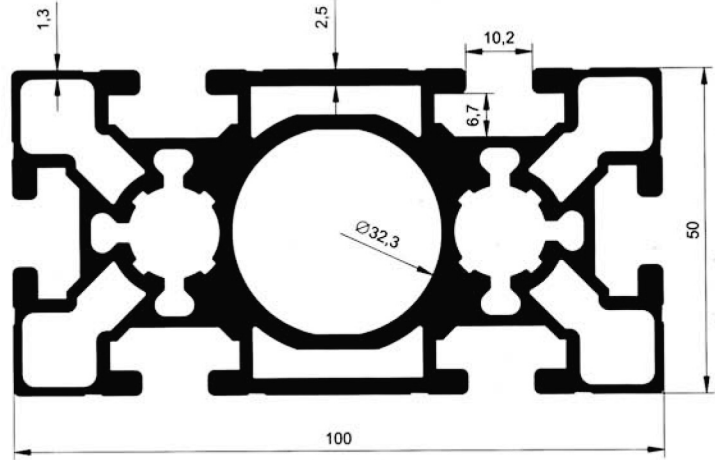

5518
4.387 kg/m

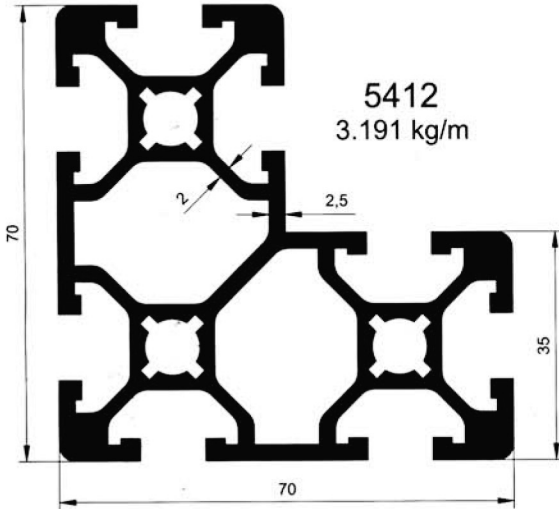

5412
3.191 kg/m

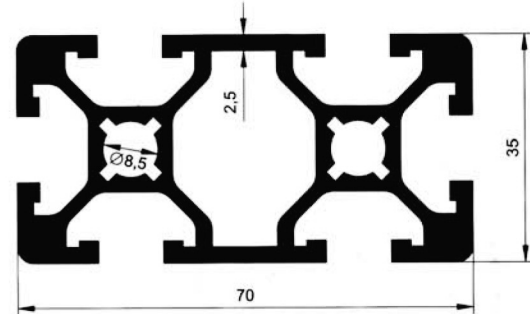

5411
2.233 kg/m

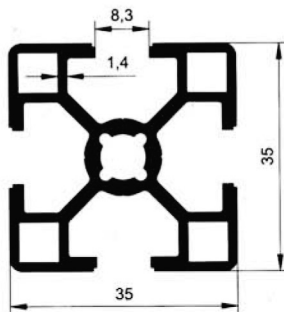

5570
0.967 kg/m

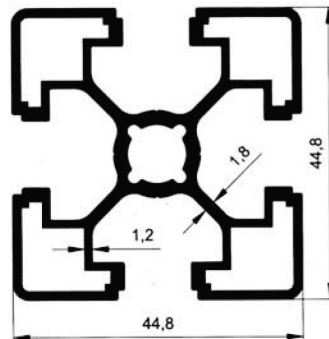

5631
1.299 kg/m

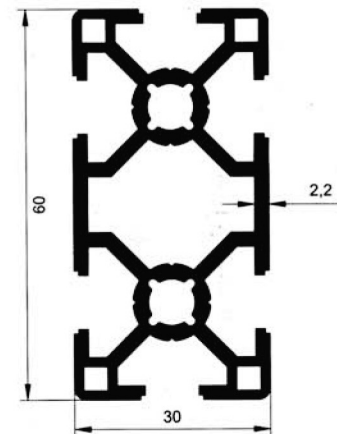

5776
1.525 kg/m



OSMANLI
ALÜMİNYUM SAN. ve TİC. LTD. ŞTİ.

- ❖ ÖZEL EBATLARDA BORU, KUTU, LAMA, KÖŞEBENT ÇEŞİTLERİ
- ❖ AYDINLATMA ve REKLAM PROFİLLERİ
- ❖ SOĞUTUCU ve LED PROFİLLERİ
- ❖ MOBİLYA ve SANAYİ PROFİLLERİ
- ❖ ÖZEL KALIP ÇİZİMLERİ ve İMALATI
- ❖ ELOKSALLI ve PRES PLAKA LEVHALARI
- ❖ GOFRAJLI ve DÜZ PARLAK RULO LEVHALARI
- ❖ LEVHA KESİM - BÜKÜM (ÖZEL ÖLÇÜLERİNİZDE)
- ❖ DELİKLİ ve DEKORATİF TELLER
- ❖ PLEXI - FOLYO - DEKOTE - POLYCARBON - KOMPOZİT VB.

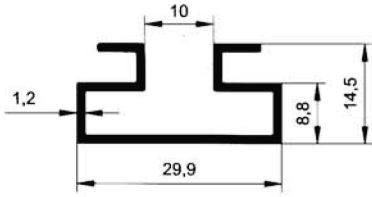

5519
0.277 kg/m

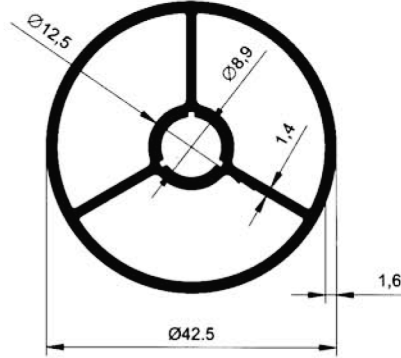

5520
0.871 kg/m

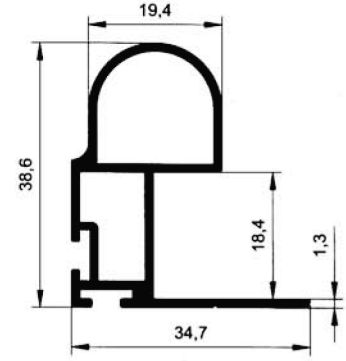

5521
0.509 kg/m

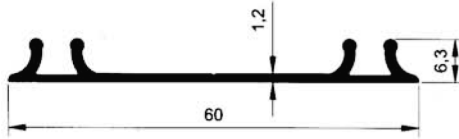

5522
0.282 kg/m

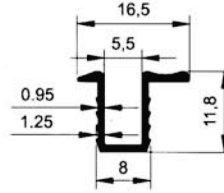

5523
0.107 kg/m

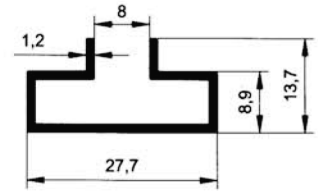

5524
0.228 kg/m

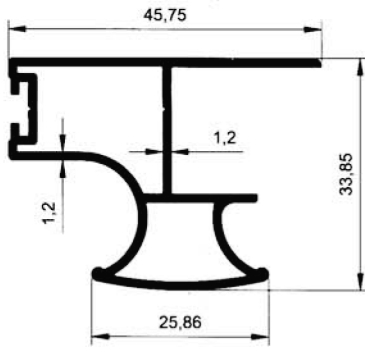

5529
0.585 kg/m

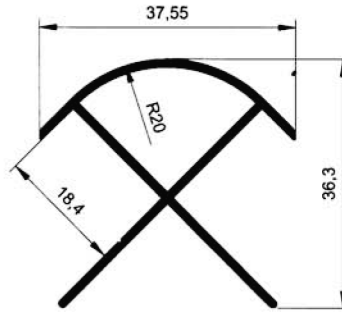

5534
0.409 kg/m

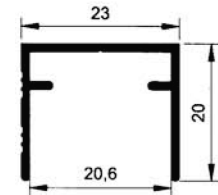

5548
0.214 kg/m

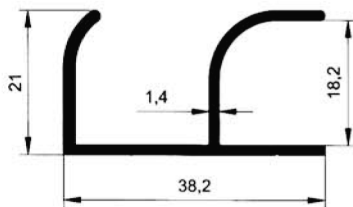

5559
0.357 kg/m

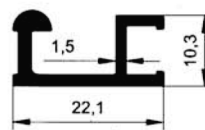

5564
0.230 kg/m

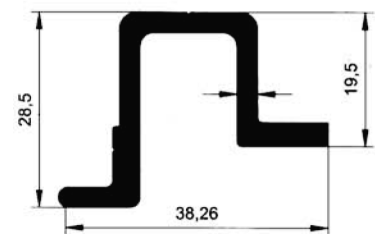

5573
0.692 kg/m



OSMANLI
ALÜMİNYUM SAN. ve TİC. LTD. ŞTİ.

- ❖ ÖZEL EBATLARDA BORU, KUTU, LAMA, KÖŞEBENT ÇEŞİTLERİ
- ❖ AYDINLATMA ve REKLAM PROFİLLERİ
- ❖ SOĞUTUCU ve LED PROFİLLERİ
- ❖ MOBİLYA ve SANAYİ PROFİLLERİ
- ❖ ÖZEL KALIP ÇİZİMLERİ ve İMALATI
- ❖ ELOKSALLI ve PRES PLAKA LEVHALARI
- ❖ GOFRAJLI ve DÜZ PARLAK RULO LEVHALARI
- ❖ LEVHA KESİM - BÜKÜM (ÖZEL ÖLÇÜLERİNİZDE)
- ❖ DELİKLİ ve DEKORATİF TELLER
- ❖ PLEXI - FOLYO - DEKOTE - POLYCARBON - KOMPOZİT VB.

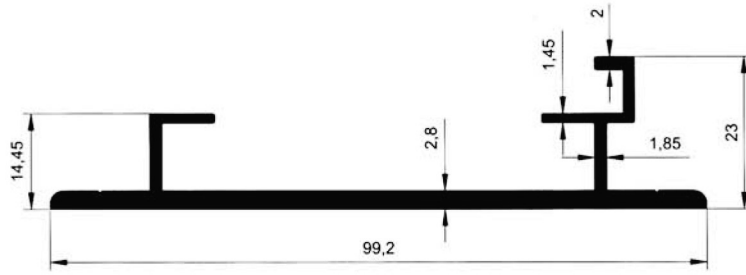

5566
1.002 kg/m

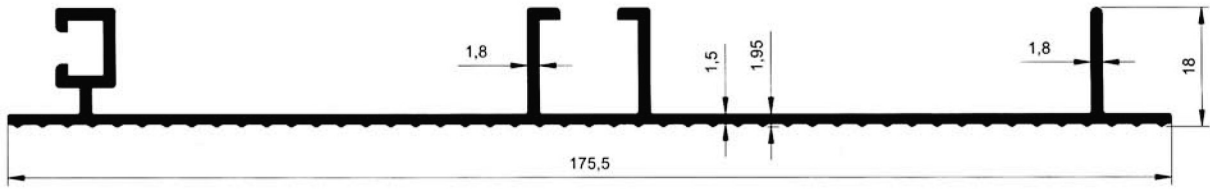

5656
BAZA
0.531 kg/m

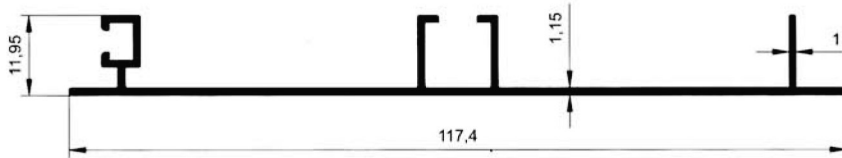

5657
BAZA
0.540 kg/m

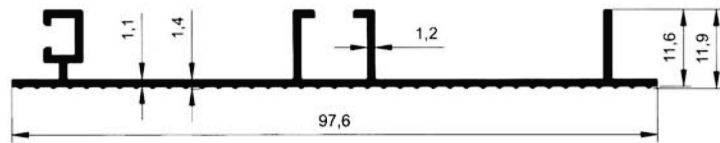

5658
BAZA
0.502 kg/m

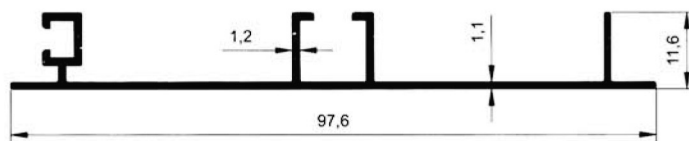

5659
BAZA
0.473 kg/m



OSMANLI
ALÜMİNYUM SAN. ve TİC. LTD. ŞTİ.

- ❖ ÖZEL EBATLARDA BORU, KUTU, LAMA, KÖŞEBENT ÇEŞİTLERİ
- ❖ AYDINLATMA ve REKLAM PROFİLLERİ
- ❖ SOĞUTUCU ve LED PROFİLLERİ
- ❖ MOBİLYA ve SANAYİ PROFİLLERİ
- ❖ ÖZEL KALIP ÇİZİMLERİ ve İMALATI
- ❖ ELOKSALLI ve PRES PLAKA LEVHALARI
- ❖ GOFRAJLI ve DÜZ PARLAK RULO LEVHALARI
- ❖ LEVHA KESİM - BÜKÜM (ÖZEL ÖLÇÜLERİNİZDE)
- ❖ DELİKLİ ve DEKORATİF TELLER
- ❖ PLEXI - FOLYO - DEKOTE - POLYCARBON - KOMPOZİT VB.

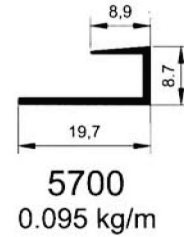
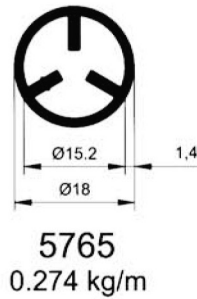
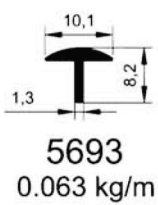
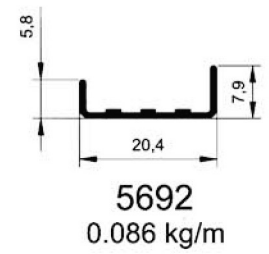
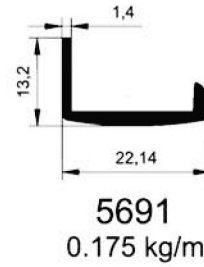
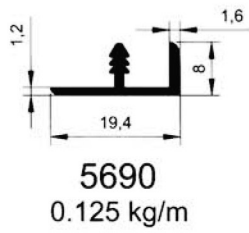
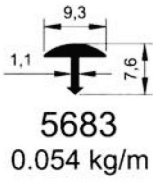
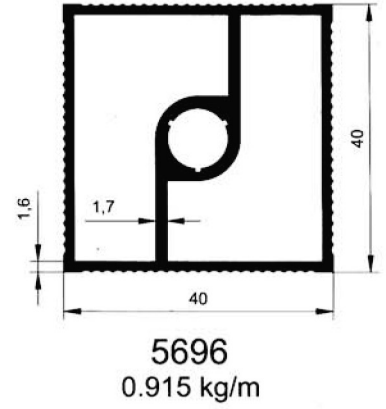
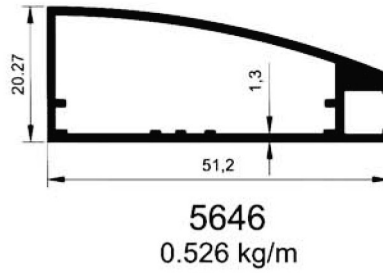
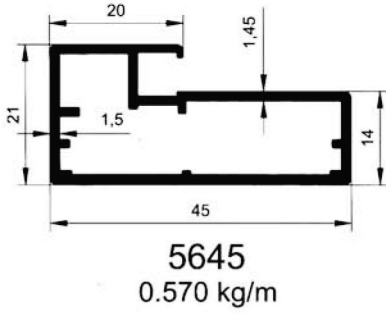
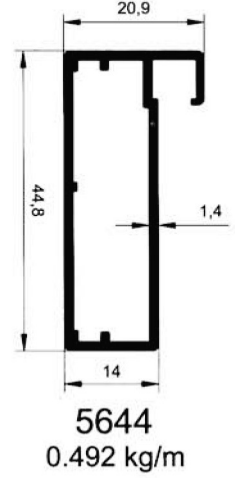
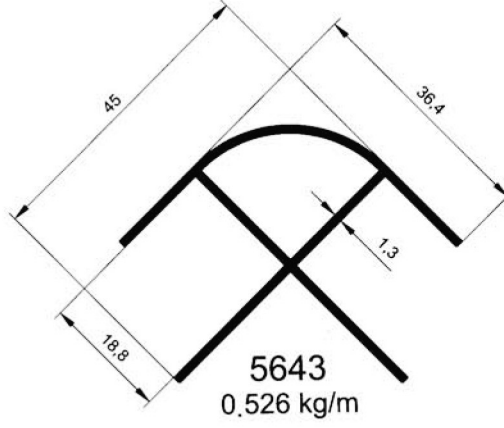
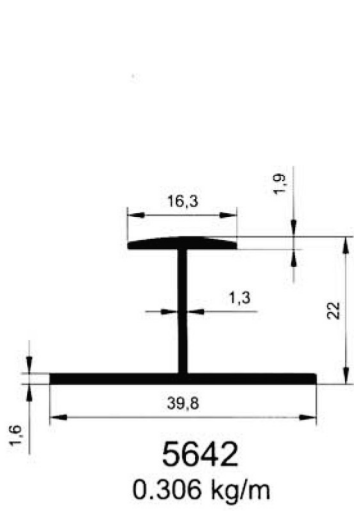



OSMANLI
ALÜMİNYUM SAN. ve TİC. LTD .ŞTİ.

- ❖ ÖZEL EBATLARDA BORU, KUTU, LAMA, KÖŞEBENT ÇEŞİTLERİ
- ❖ AYDINLATMA ve REKLAM PROFİLLERİ
- ❖ SOĞUTUCU ve LED PROFİLLERİ
- ❖ MOBİLYA ve SANAYİ PROFİLLERİ
- ❖ ÖZEL KALIP ÇİZİMLERİ ve İMALATI
- ❖ ELOKSALLI ve PRES PLAKA LEVHALARI
- ❖ GOFRAJLI ve DÜZ PARLAK RULO LEVHALARI
- ❖ LEVHA KESİM - BÜKÜM (ÖZEL ÖLÇÜLERİNİZDE)
- ❖ DELİKLİ ve DEKORATİF TELLER
- ❖ PLEXI - FOLYO - DEKOTE - POLYCARBON - KOMPOZİT VB.

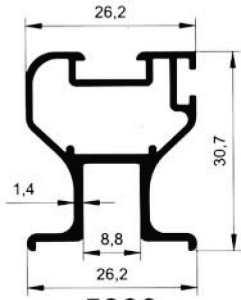

5800
0.436 kg/m

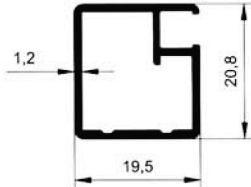

5801
0.268 kg/m

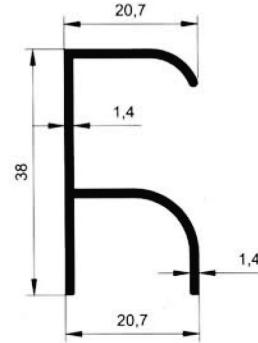

5802
0.338 kg/m

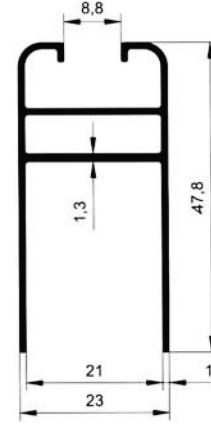

5803
0.427 kg/m

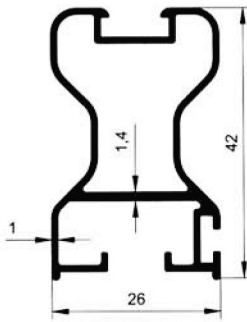

5804
0.495 kg/m

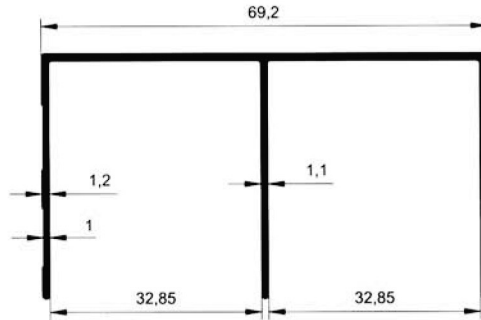

5805
0.551 kg/m

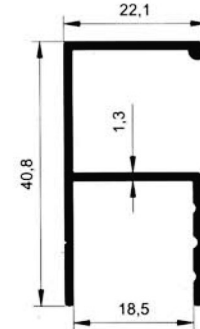

5806
0.391 kg/m

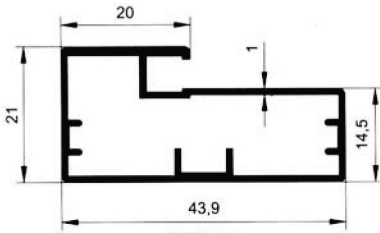

5807
0.443 kg/m

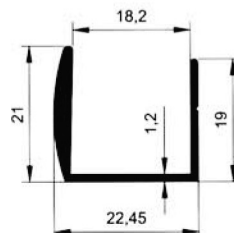

5808
0.247 kg/m

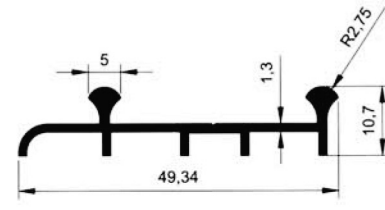

5809
0.318 kg/m

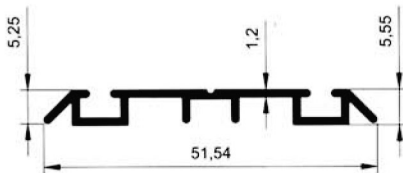

5810
0.281 kg/m

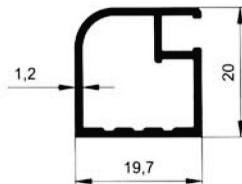

5811
0.265 kg/m

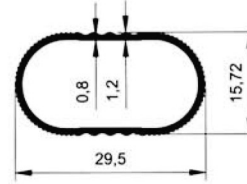

5812
0.198 kg/m

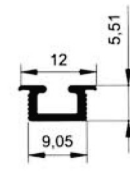

5813
0.070 kg/m



OSMANLI
ALÜMİNYUM SAN. ve TİC. LTD .ŞTİ.

- ❖ ÖZEL EBATLARDA BORU, KUTU, LAMA, KÖŞEBENT ÇEŞİTLERİ
- ❖ AYDINLATMA ve REKLAM PROFİLLERİ
- ❖ SOĞUTUCU ve LED PROFİLLERİ
- ❖ MOBİLYA ve SANAYİ PROFİLLERİ
- ❖ ÖZEL KALIP ÇİZİMLERİ ve İMALATI
- ❖ ELOKSALLI ve PRES PLAKA LEVHALARI
- ❖ GOFRAJLI ve DÜZ PARLAK RULO LEVHALARI
- ❖ LEVHA KESİM - BÜKÜM (ÖZEL ÖLÇÜLERİNİZDE)
- ❖ DELİKLİ ve DEKORATİF TELLER
- ❖ PLEXI - FOLYO - DEKOTE - POLYCARBON - KOMPOZİT VB.

BÖLME VE PANEL PROFİLLERİ

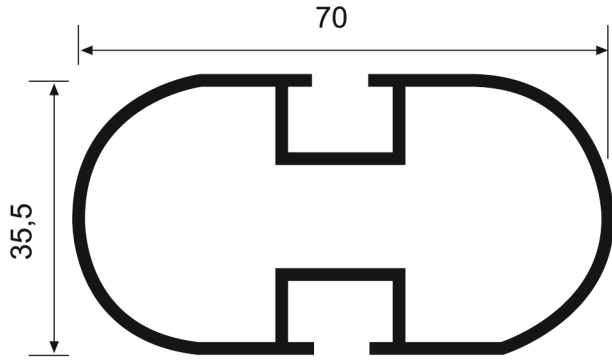

1533

(0,700 Kg/m)

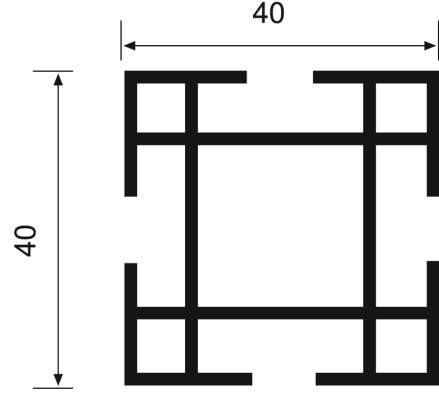

1993

(1,350 Kg/m)

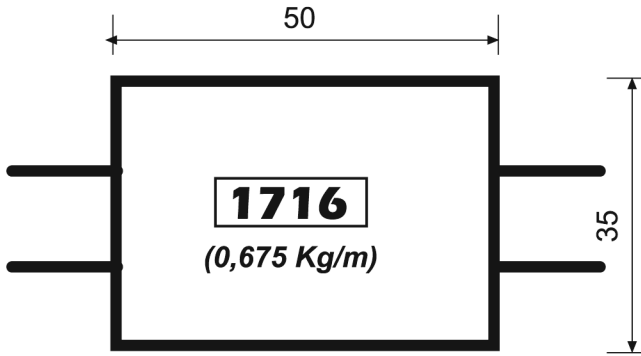

1716

(0,675 Kg/m)

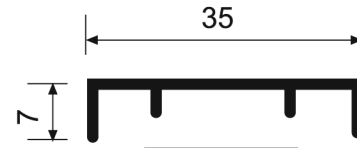

1717

(0,180 Kg/m)

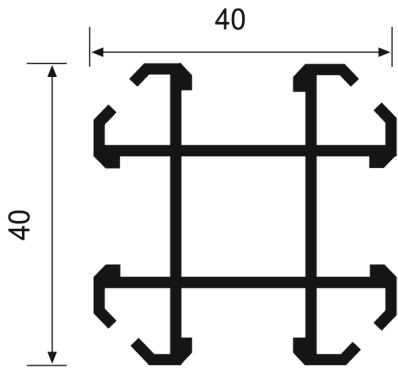

1715

(0,940 Kg/m)

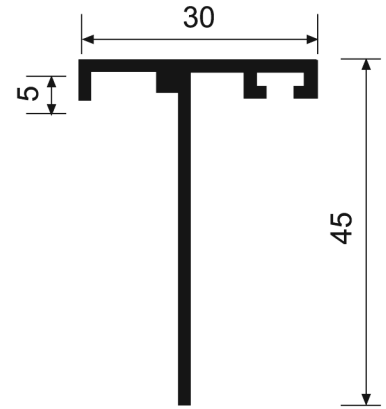

1994

(0,420 Kg/m)

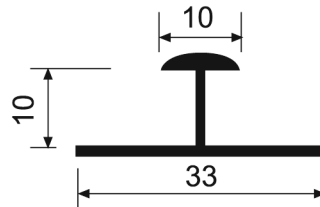

1896

(0,220 Kg/m)



1753

(0,310 Kg/m)



OSMANLI
ALÜMİNYUM SAN. ve TİC. LTD. ŞTİ.

- ❖ ÖZEL EBATLARDA BORU, KUTU, LAMA, KÖŞEBENT ÇEŞİTLERİ
- ❖ AYDINLATMA ve REKLAM PROFİLLERİ
- ❖ SOĞUTUCU ve LED PROFİLLERİ
- ❖ MOBİLYA ve SANAYİ PROFİLLERİ
- ❖ ÖZEL KALIP ÇİZİMLERİ ve İMALATI
- ❖ ELOKSALLI ve PRES PLAKA LEVHALARI
- ❖ GOFRAJLI ve DÜZ PARLAK RULO LEVHALARI
- ❖ LEVHA KESİM - BÜKÜM (ÖZEL ÖLÇÜLERİNİZDE)
- ❖ DELİKLİ ve DEKORATİF TELLER
- ❖ PLEXI - FOLYO - DEKOTE - POLYCARBON - KOMPOZİT VB.

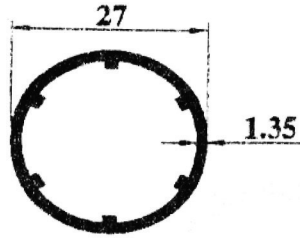

1274
0,330 kg/m

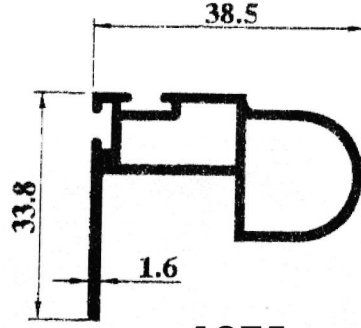

1275
0,520 kg/m

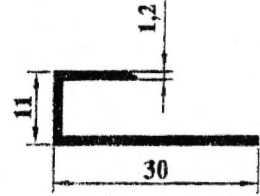

1276
0.165 kg/m

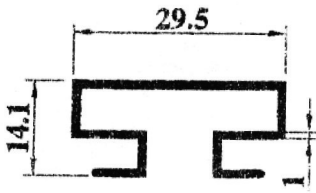

1277
0,230 kg/m

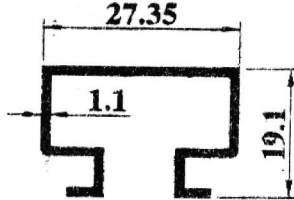

1278
0,254 kg/m

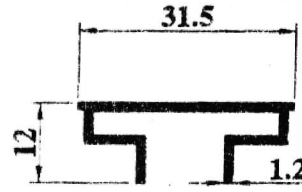

1279
0,223 kg/m

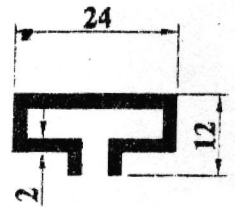

1280
0,325 kg/m

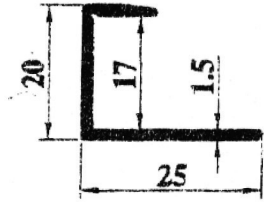

1281
0,200 kg/m

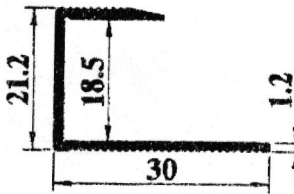

1282
0,185 kg/m

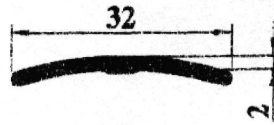

1283
0,180 kg/m

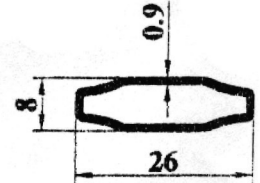

1284
0,170 kg/m

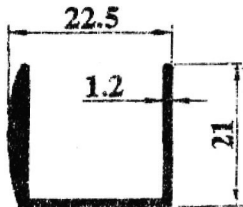

1285
0,250 kg/m

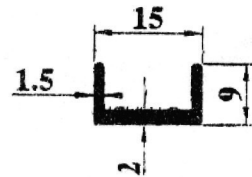

1286
0,140 kg/m

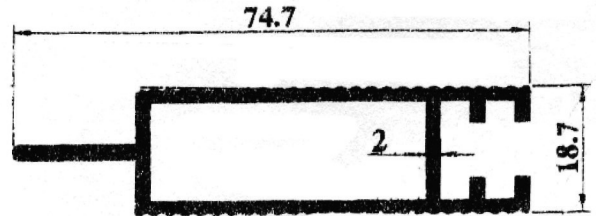

1287
0,870 kg/m



OSMANLI
ALÜMİNYUM SAN. ve TİC. LTD. ŞTİ.

- ❖ ÖZEL EBATLARDA BORU, KUTU, LAMA, KÖŞEBENT ÇEŞİTLERİ
- ❖ AYDINLATMA ve REKLAM PROFİLLERİ
- ❖ SOĞUTUCU ve LED PROFİLLERİ
- ❖ MOBİLYA ve SANAYİ PROFİLLERİ
- ❖ ÖZEL KALIP ÇİZİMLERİ ve İMALATI
- ❖ ELOKSALLI ve PRES PLAKA LEVHALARI
- ❖ GOFRAJLI ve DÜZ PARLAK RULO LEVHALARI
- ❖ LEVHA KESİM - BÜKÜM (ÖZEL ÖLÇÜLERİNİZDE)
- ❖ DELİKLİ ve DEKORATİF TELLER
- ❖ PLEXI - FOLYO - DEKOTE - POLYCARBON - KOMPOZİT VB.

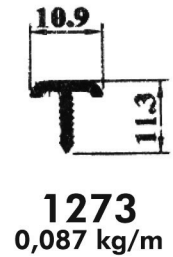
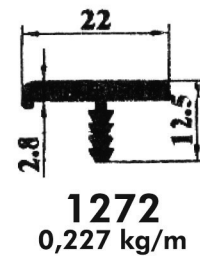
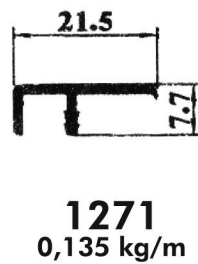
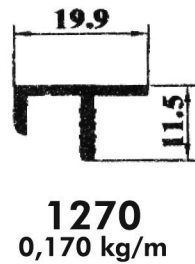
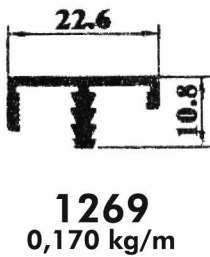
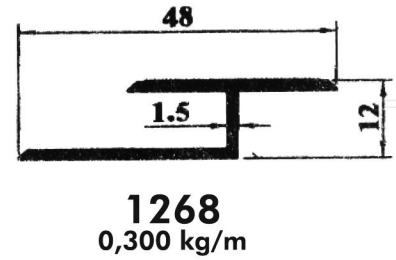
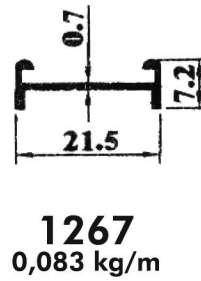
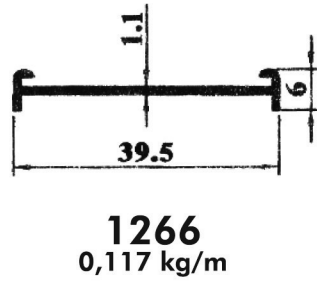
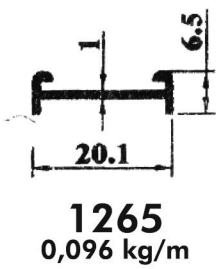
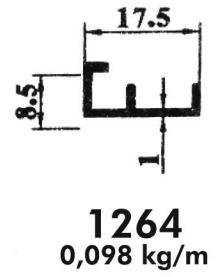
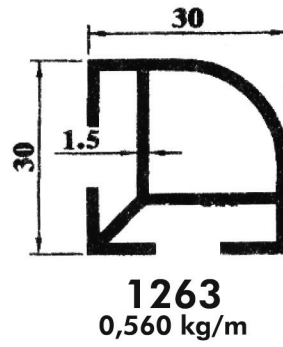
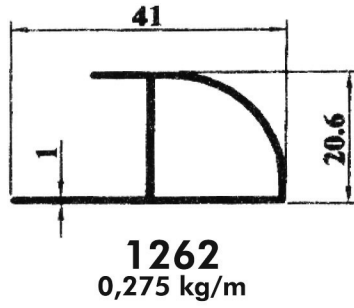
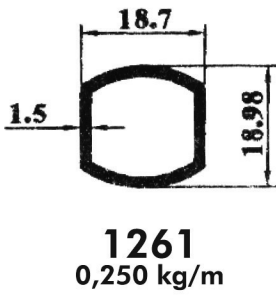
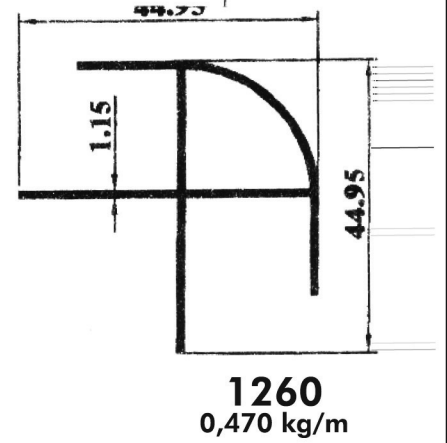
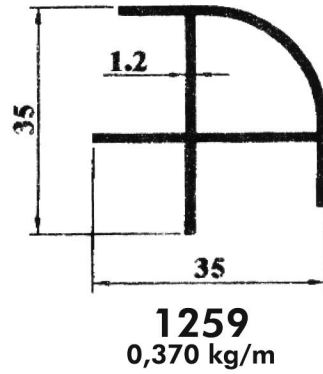
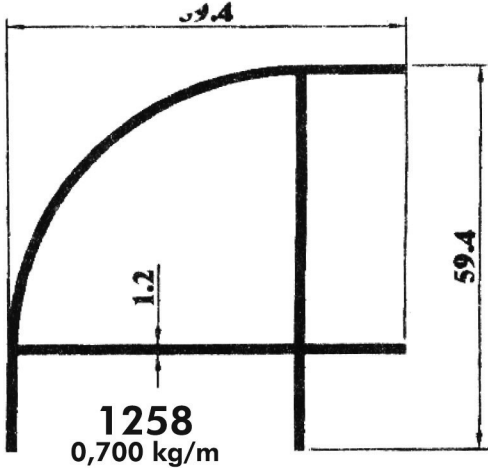



OSMANLI
ALÜMİNYUM SAN. ve TİC. LTD. ŞTİ.

- ❖ ÖZEL EBATLARDA BORU, KUTU, LAMA, KÖŞEBENT ÇEŞİTLERİ
- ❖ AYDINLATMA ve REKLAM PROFİLLERİ
- ❖ SOĞUTUCU ve LED PROFİLLERİ
- ❖ MOBİLYA ve SANAYİ PROFİLLERİ
- ❖ ÖZEL KALIP ÇİZİMLERİ ve İMALATI
- ❖ ELOKSALLI ve PRES PLAKA LEVHALARI
- ❖ GOFRAJLI ve DÜZ PARLAK RULO LEVHALARI
- ❖ LEVHA KESİM - BÜKÜM (ÖZEL ÖLÇÜLERİNİZDE)
- ❖ DELİKLİ ve DEKORATİF TELLER
- ❖ PLEXI - FOLYO - DEKOTE - POLYCARBON - KOMPOZİT VB.

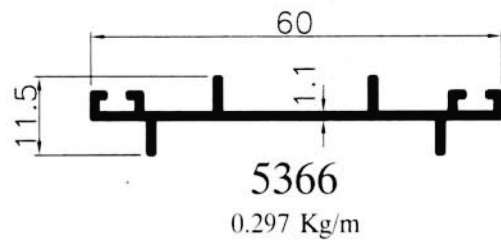
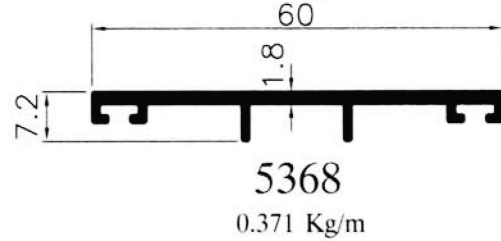
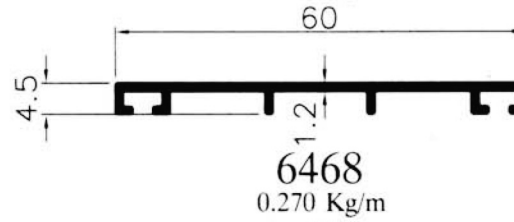
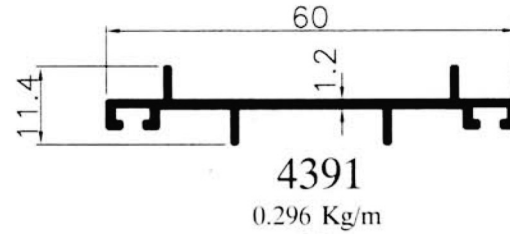
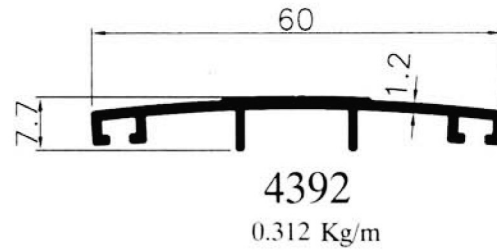
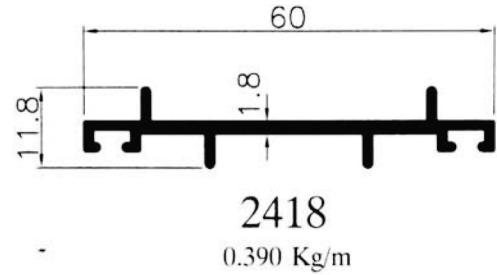
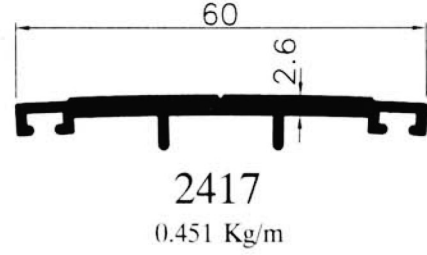
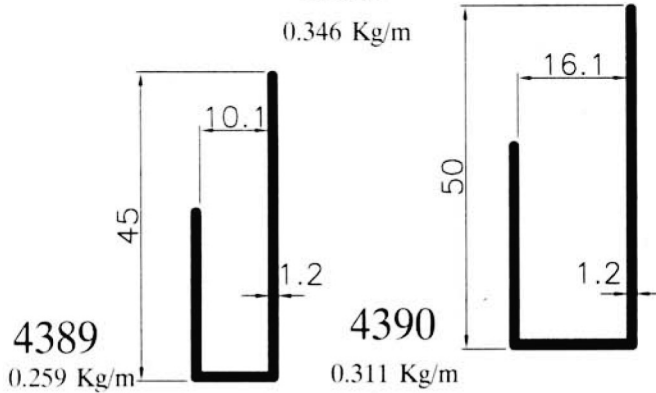
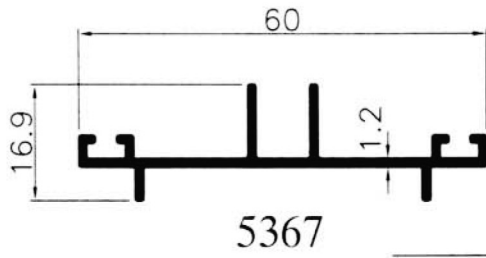
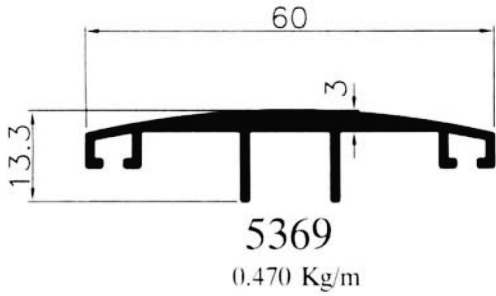
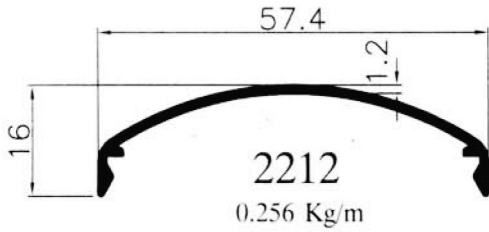
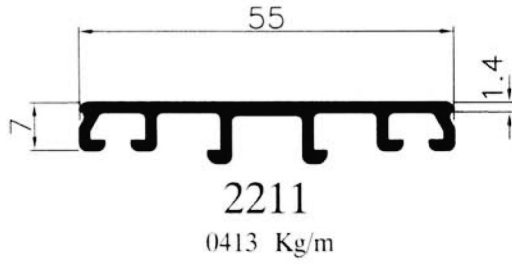
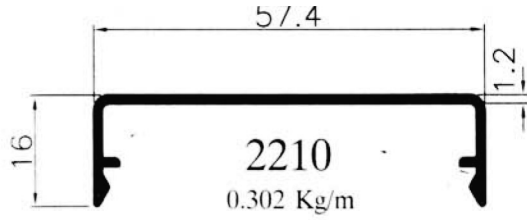



OSMANLI
ALÜMİNYUM SAN. ve TİC. LTD. ŞTİ.

- ❖ ÖZEL EBATLARDA BORU, KUTU, LAMA, KÖŞEBENT ÇEŞİTLERİ
- ❖ AYDINLATMA ve REKLAM PROFİLLERİ
- ❖ SOĞUTUCU ve LED PROFİLLERİ
- ❖ MOBİLYA ve SANAYİ PROFİLLERİ
- ❖ ÖZEL KALIP ÇİZİMLERİ ve İMALATI
- ❖ ELOKSALLI ve PRES PLAKA LEVHALARI
- ❖ GOFRAJLI ve DÜZ PARLAK RULO LEVHALARI
- ❖ LEVHA KESİM - BÜKÜM (ÖZEL ÖLÇÜLERİNİZDE)
- ❖ DELİKLİ ve DEKORATİF TELLER
- ❖ PLEXI - FOLYO - DEKOTE - POLYCARBON - KOMPOZİT VB.

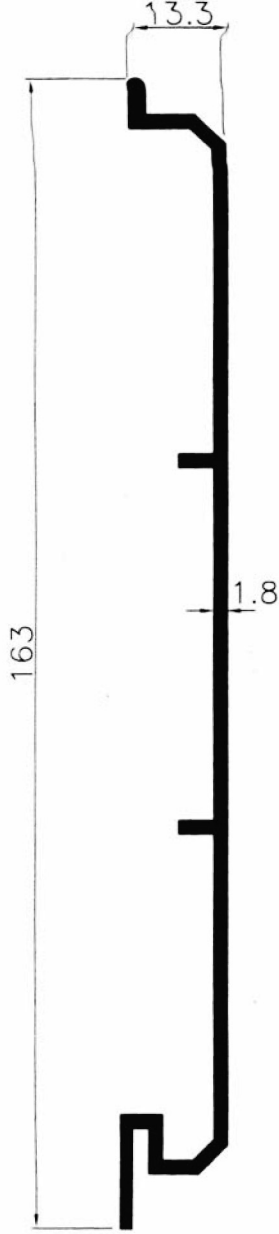

1640
0.998 Kg/m

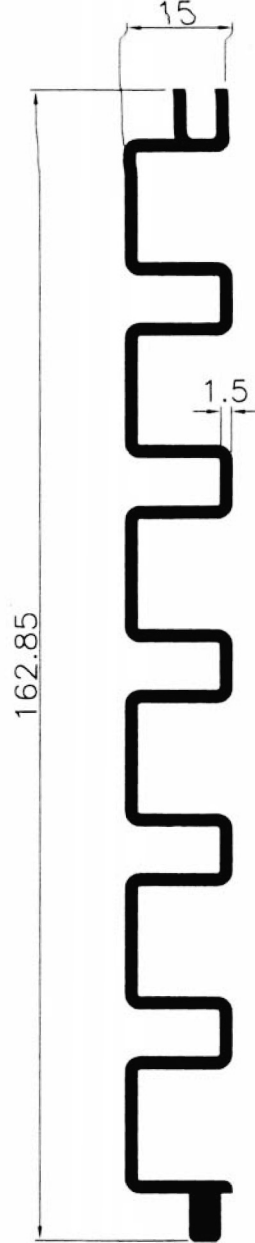

3378
1.345 Kg/m

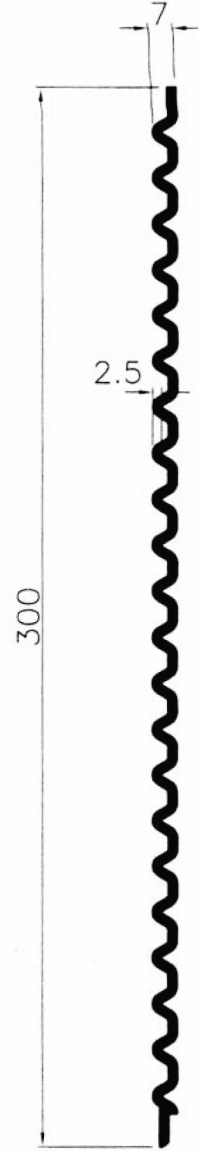

4649
2.674 Kg/m
Ölçek: 1/2



OSMANLI
ALÜMİNYUM SAN. ve TİC. LTD .ŞTİ.

- ❖ ÖZEL EBATLARD A BORU, KUTU, LAMA, KÖŞEBENT ÇEŞİTLERİ
- ❖ AYDINLATMA ve REKLAM PROFİLLERİ
- ❖ SOĞUTUCU ve LED PROFİLLERİ
- ❖ MOBİLYA ve SANAYİ PROFİLLERİ
- ❖ ÖZEL KALIP ÇİZİMLERİ ve İMALATI
- ❖ ELOKSALLI ve PRES PLAKA LEVHALARI
- ❖ GOFRAJLI ve DÜZ PARLAK RULO LEVHALARI
- ❖ LEVHA KESİM - BÜKÜM (ÖZEL ÖLÇÜLERİNİZDE)
- ❖ DELİKLİ ve DEKORATİF TELLER
- ❖ PLEXI - FOLYO - DEKOTE - POLYCARBON - KOMPOZİT VB.

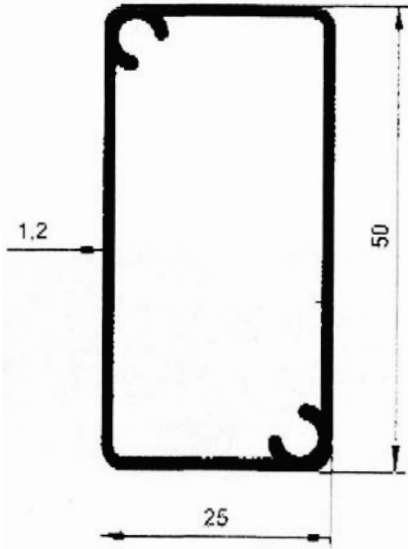

5586
0.520 kg/m

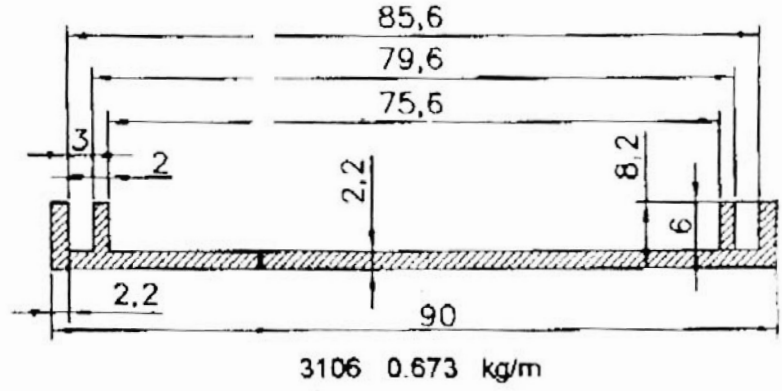

3106 0.673 kg/m

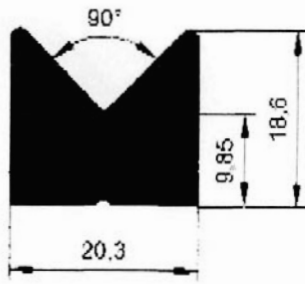

5596
0.810 kg/m

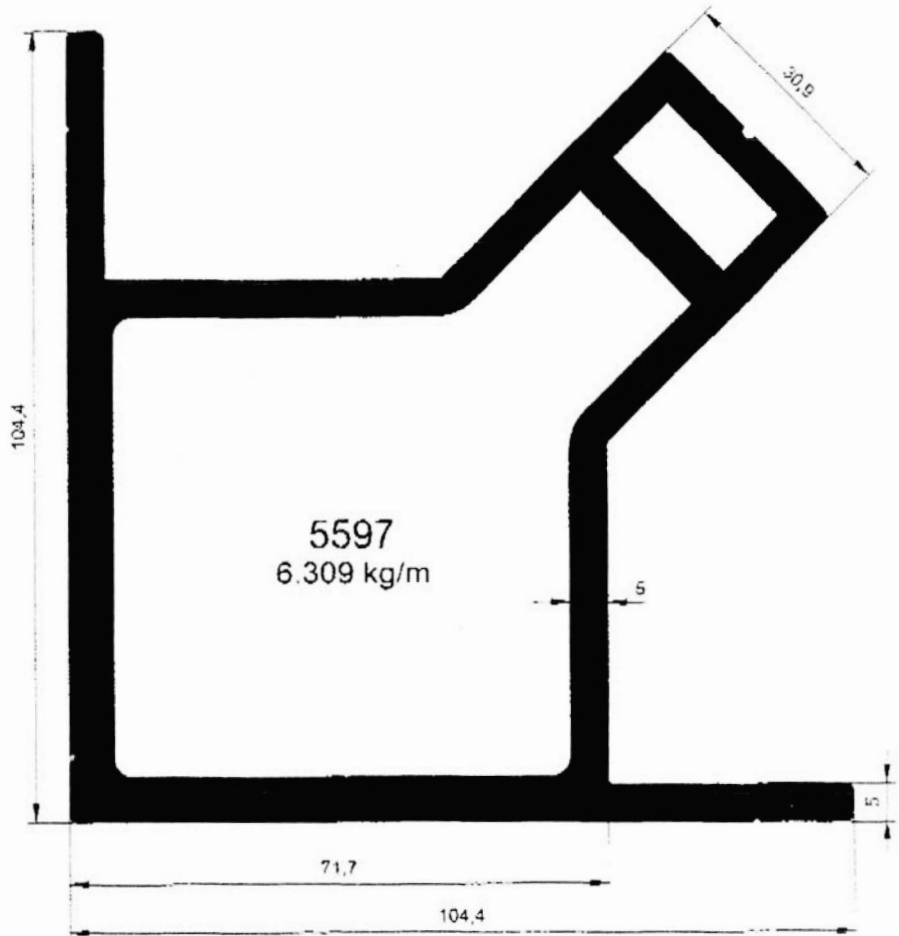

5597
6.309 kg/m



OSMANLI
ALÜMİNYUM SAN. ve TİC. LTD. ŞTİ.

- ❖ ÖZEL EBATLARDA BORU, KUTU, LAMA, KÖŞEBENT ÇEŞİTLERİ
- ❖ AYDINLATMA ve REKLAM PROFİLLERİ
- ❖ SOĞUTUCU ve LED PROFİLLERİ
- ❖ MOBİLYA ve SANAYİ PROFİLLERİ
- ❖ ÖZEL KALIP ÇİZİMLERİ ve İMALATI
- ❖ ELOKSALLI ve PRES PLAKA LEVHALARI
- ❖ GOFRAJLI ve DÜZ PARLAK RULO LEVHALARI
- ❖ LEVHA KESİM - BÜKÜM (ÖZEL ÖLÇÜLERİNİZDE)
- ❖ DELİKLİ ve DEKORATİF TELLER
- ❖ PLEXI - FOLYO - DEKOTE - POLYCARBON - KOMPOZİT VB.

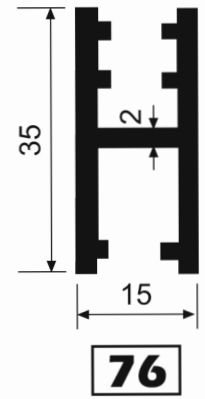
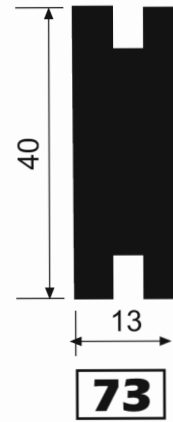
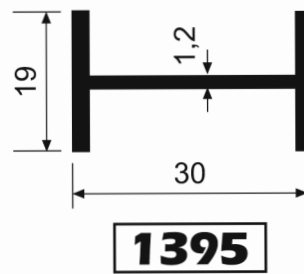
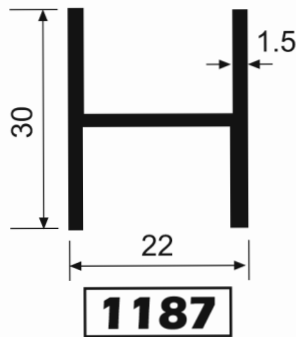
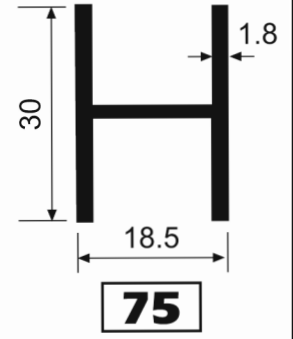
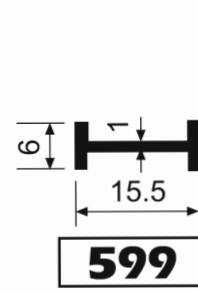
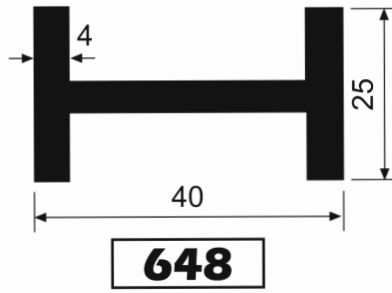
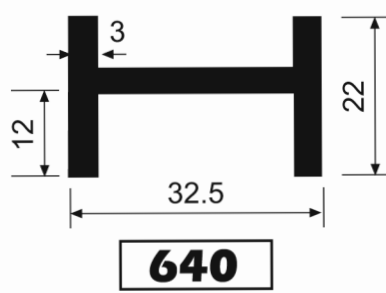
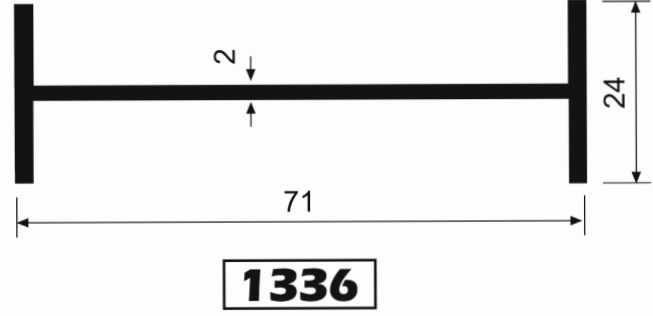
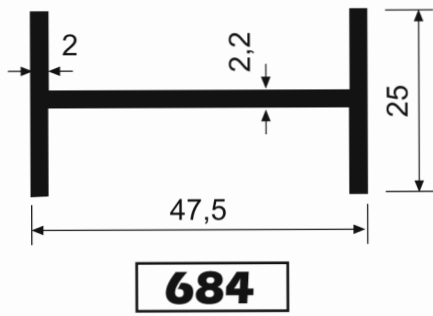
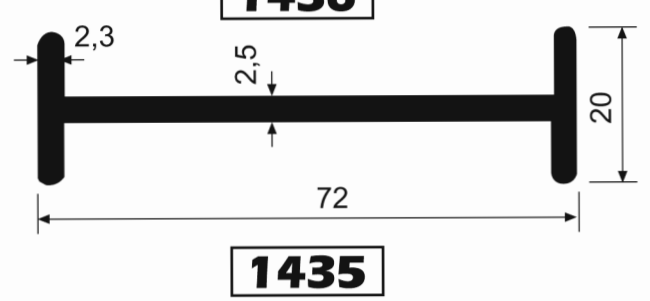
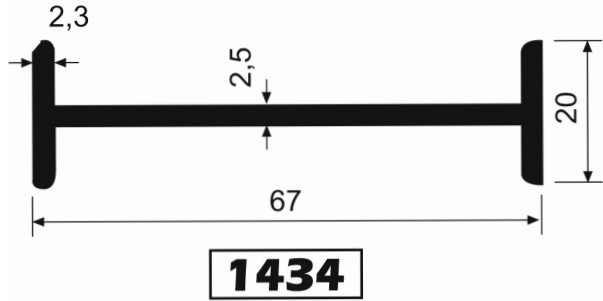
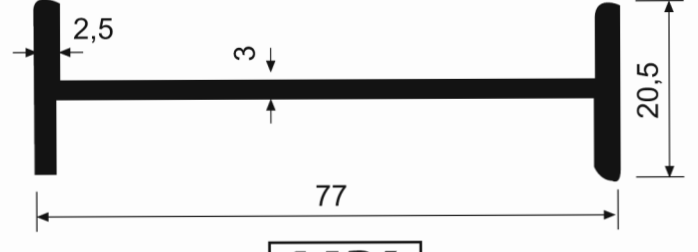
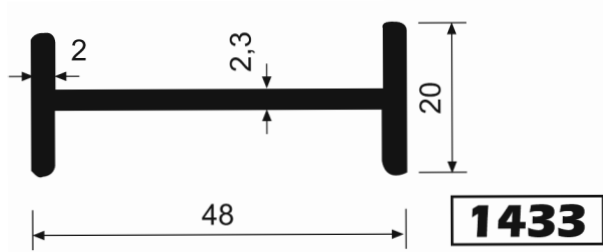

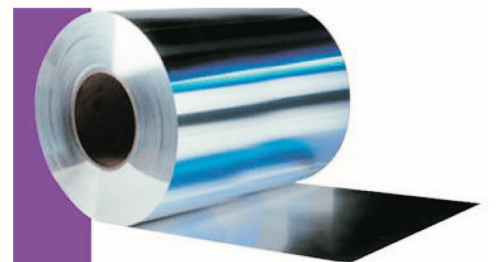
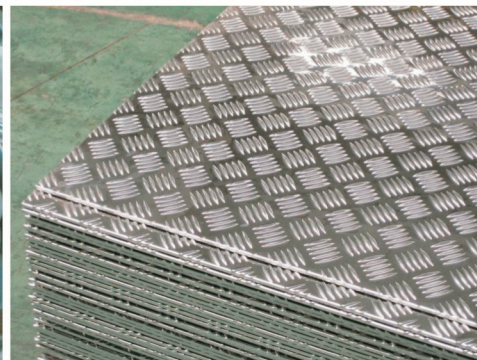
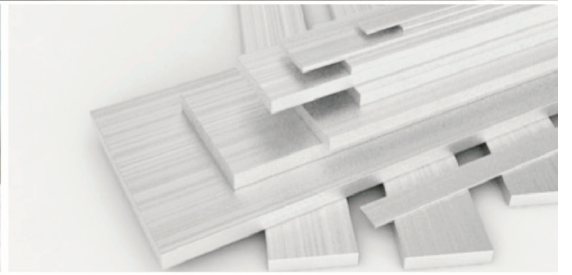

OSMANLI

ALÜMİNYUM SAN. ve TİC. LTD. ŞTİ.

AYDINLATMA PROFİLLERİ

Aydınlatma'daki çözüm ortağınız

www.aydinlatmaprofilleri.com

tarik@osmanlialuminyum.com

